

# Mirro Pressure Cooker & Canners Instructions Manual & Recipe Book

Congratulations on your choice!

Your **MIRRO** or *Kitchen Pro* Pressure Cooker/ Canner was carefully developed by Designers, Technicians and Cooking Instructors with the goal of making your daily routine more efficient and dynamic. We call your attention especially to the Safety Systems, which have resulted in an harmonious set by marrying Technology, Functionality and Beauty. Since Pressure Cookers work differently than conventional cookers, your Pressure Cooker/ Canner **REQUIRES THAT YOU PAY SPECIAL ATTENTION TO THE USE AND SAFETY INSTRUCTIONS.**

**WARNING: Improper use can result in burns and injury. Read and follow instructions before use.**

## TABLE of CONTENTS

- [Important Safeguards](#) – Pg 2
- [How to Open and Close](#) – Pg 3
- [Features of Your Pressure Cooker/ Canner](#) – pg 4
- [How to Use Your Pressure Cooker/ Canner](#) – Pg 5
- [Steam Leakage](#) – Pg 7
- [How to Clean Your Pressure Cooker/ Canner](#) – Pg 7
- [Safety Systems](#) – Pg 8
- [Replacement Parts](#) – Pg 9
- [How to Identify Your Pressure Cooker/ Canner](#) – Pg 10
- [Certificate of Warranty](#) – Pg 11
- [Questions and Answers](#) – Pg 11
- [Cooking Timetables](#) – Pg 12
  - [Meat and Poultry](#) – Pg 13
  - [Fish and Seafood](#) – Pg 14
  - [Fresh Vegetables](#) – Pg 15
  - [Dried Vegetables](#) – Pg 17
- Recipes for Your Pressure Cooker/ Canner
  - [Beef](#) – Pg 17
  - [Pork](#) – Pg 23
  - [Fish and Seafood](#) – Pg 26
  - [Veal, Lamb, Poultry and Game](#) – Pg 28
  - [Vegetables and Soups](#) – Pg 31
- Canning
  - [How to](#) – Pg 34
  - [Charts](#) – Pg 36
  - [Meat and Fish](#) – Pg 37
  - [Vegetables](#) – Pg 38
  - [Fruit](#) – Pg 40
  - [Syrup for Fruit](#) – Pg 41
  - [Problems](#) – Pg 42

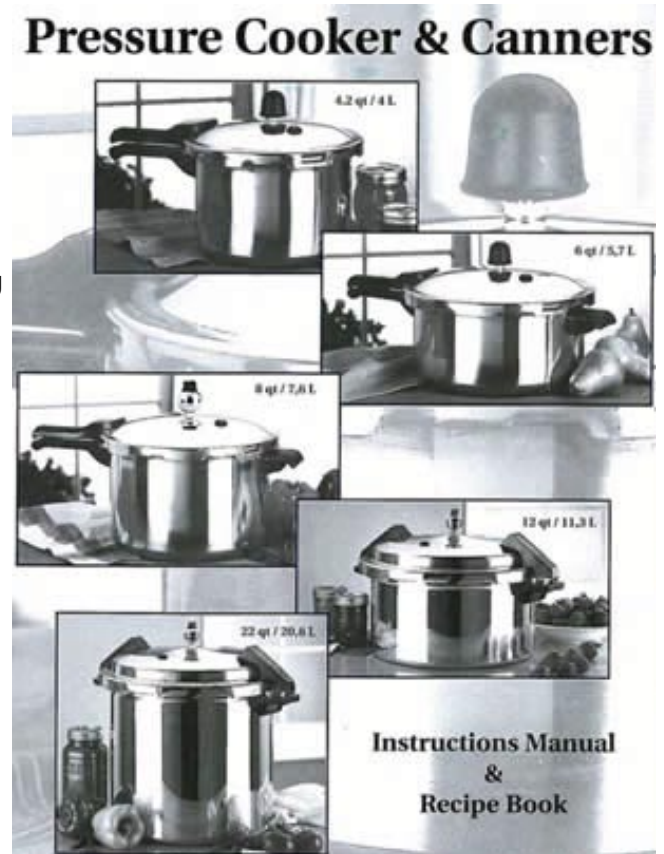

**PLEASE CAREFULLY READ THE INSTRUCTIONS IN THIS MANUAL BEFORE USING YOUR PRESSURE COOKER/ CANNER, SINCE ITS INCORRECT USE CAN RESULT IN BURNS AND OTHER SERIOUS ACCIDENTS.**

# Important Safeguards

When using pressure cookers, basic safety precautions should always be followed. If you have a question on the proper operation of your pressure cooker please call our Consumer Center at 1-800-527-7727.

1. Read all instructions before using your pressure cooker.
2. **Before each use make sure the vent tube is clear.** Remove the pressure control and place the lid against the light to make sure that the tube is clear. If plugged clean all holes with a piece of wire. See [Vent Tube Check](#).
3. **Never cook APPLESAUCE, CRANBERRIES, PEARL BARLEY, SPLIT PEASE, RHUBARB, NOODLES, MACARONI, SPAGHETTI or OTHER PASTA, OATMEAL or OTHER CEREALS in a pressure cooker.** These foods tend to foam, froth and splutter, and can plug the vent tube.  
**WARNING:** If the vent tube is plugged, the overpressure devices can open and spray scalding hot steam and food. Keep head and face away from cooker. See [How to Use Your Pressure Cooker](#).
4. **Never fill your pressure cooker more than 2/3 full. When cooking foods that puff up during cooking, such as rice and dried vegetables, do not fill more than 1/2 full.**  
**WARNING:** Overfilling the cooker can plug the vent tube causing a release of scalding steam from the overpressure devices. See [How to Use Your Pressure Cooker](#).
5. This appliance cooks under pressure. make absolutely sure your pressure cooker is properly closed before placing on heat. **The cooker is closed when the lid handle is directly over the handle of the pan.**  
**WARNING:** Improper closure of the lid can cause the lid to be thrown from the pan. See [How to Open and Close](#).
6. If the overpressure devices release, protect yourself from the steam and turn off heat and allow the cooker to cool. The reusable overpressure plug may be reset. If the gasket has blown out of the overpressure window replace with a new gasket. Do not reuse.
7. Never try to open your pressure cooker until the cooker is thoroughly cool and the internal pressure is down. When the pressure is down the lid should turn easily. Never try to force open the lid if it seems locked tight. See [Food Removal](#).
8. Never remove the Pressure Control during cooking or when the cooker is still hot. Steam will release through the vent tube that can cause burns.
9. Supervise children closely when using your pressure cooker near children. Keep handles turned toward the inside of the stove.
10. Always remove the gasket before using the cooker as a conventional (non Pressurized) covered pan without the pressure control. If you leave the gasket in, some pressure can develop in the cooker. Without the gasket, no pressure will develop.
11. Never use your Pressure Cooker for other than its intended use: cooking appropriate foods under pressure on residential ranges. Never place the cooker inside a heated oven. Do not use the cooker outdoors.
12. Never use your pressure Cooker for pressure frying with oil and never "broast" (pressure cook with oil or shortening instead of water) in your cooker.
13. Do not touch hot metal surfaces. Use handles or knobs. Be extremely careful when moving a pressure cooker full of hot liquids.

Save these instructions.

# How to Open and Close

## To Close

Find OPEN-CLOSE on top of the lid located left of the lid handle. Turn and place lid so the arrow is pointing toward the center of the pan handle, Fig. A. next turn the lid clockwise, Fig. B, **until the handle on the lid is directly over the handle on the pan**, Fig .C.

## To Open

To open, turn the lid counterclockwise, Fig. D, until the arrow **OPEN-CLOSE** points to the center of the Pan Handle, lifting the lid to open, Fig .E. Practice this operation several times until you master it. If the lid is hard to turn, lubricate the Rubber Gasket with cooking oil. Excessive lubrication may deform the Rubber Gasket. Do not lubricate the Rubber Gasket after the third time you've used your Pressure Cooker.

Whenever the cooker is in use or under pressure, the handle on the lid must always be over the handle on the pan. Never use force to open and never open when under pressure. Consult How to Use Your Pressure Cooker.

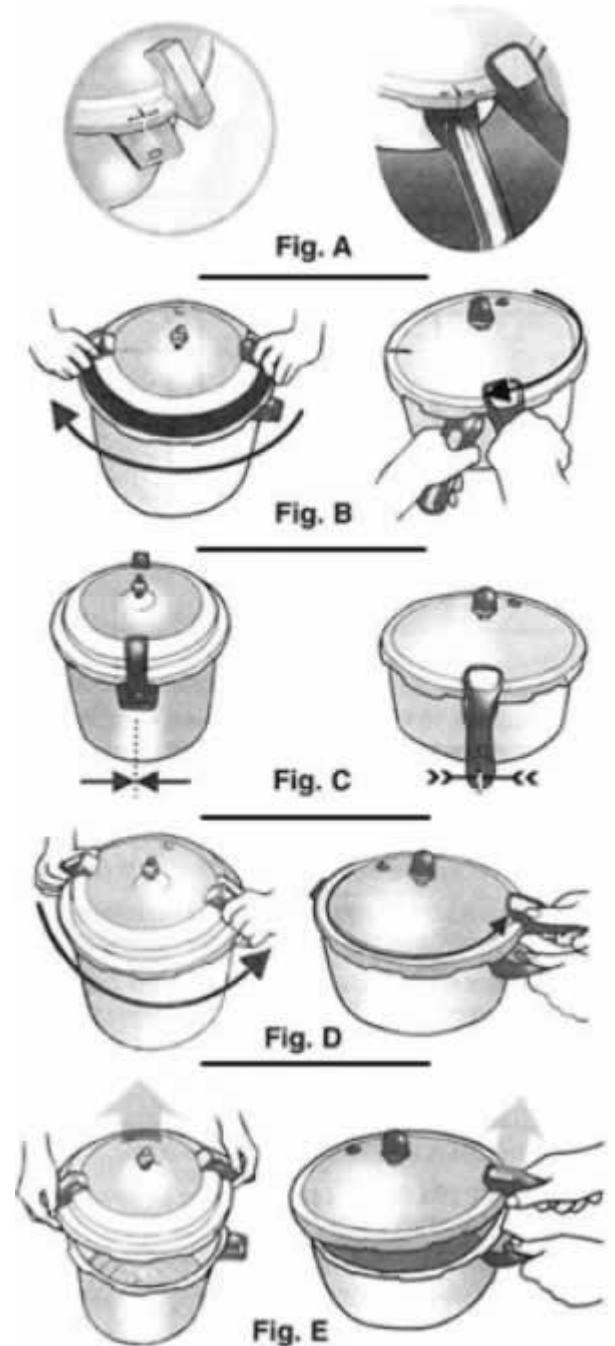

# Features of Your Pressure Cooker

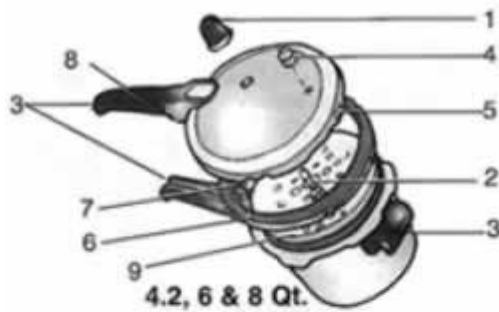

**Single and Selective Pressure Controls ARE NOT Interchangeable**

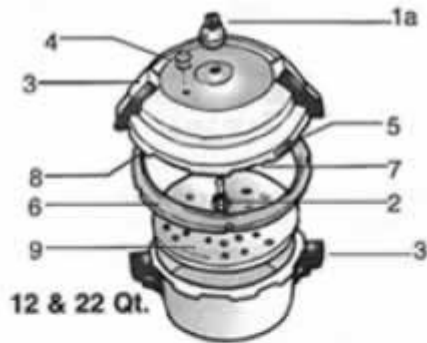

1. - **SINGLE PRESSURE CONTROL** Keeps internal pressure steady, it is an automatic cooking control, operating at a pressure of 10 PSI (pounds per square inch). Included with 4.2 & 6 Qt. Models.
- a. - **SELECTIVE PRESSURE CONTROL** Keeps internal pressure steady, allowing the selection of 3 cooking pressures: 5, 10 and 15 PSI. To disassemble the Selective Pressure Control, turn the knob keeping the rest of the assembly fixed, until the notches of the knob are aligned with the notches of the assembly, thus releasing the components of the control. Included with 8, 12 & 22 Qt. Models.
- b. - **VENT TUBE** Fastened to the center of the lid, having holes allowing for the release of steam. The Single Pressure Control or Selective Pressure Control is connected to the top.
- c. - **PAN AND LID HANDLES** Allow the opening and closing of your Pressure Cooker as well as it's handling. If handles become loose tighten with a screw driver.
- **REUSABLE OVERPRESSURE PLUG** It will release if the vent tube becomes plugged and the cooker develops too much pressure. The red pin in the center pushed out, releasing steam (Fig. A) on page 7.
- d. - **SAFETY WINDOW** This is an additional feature that will release if the vent tube and reusable overpressure plug becomes plugged and the cooker develops too much pressure. The rubber gasket will push out from the lid opening releasing the steam.
- e. - **RUBBER GASKET** Fitted inside the lid, it's function is to seal the lid of the pan of the Pressure Cooker.
- f. - **SAFETY LOCKS** Located on the lid and pan are locking lags, this feature prevents the opening of the lid of your pressure cooker when pressurized.
- g. - **SPRING SAFETY DEVICE** Located in the lid handle or lid. Its function is to prevent the pressurization of your cooker before being closed.
- h. - **COOKING RACK** To prevent food from sticking to the bottom of the cooker and to place jars off the bottom of the 8, 12 and 22 Qt. canners.

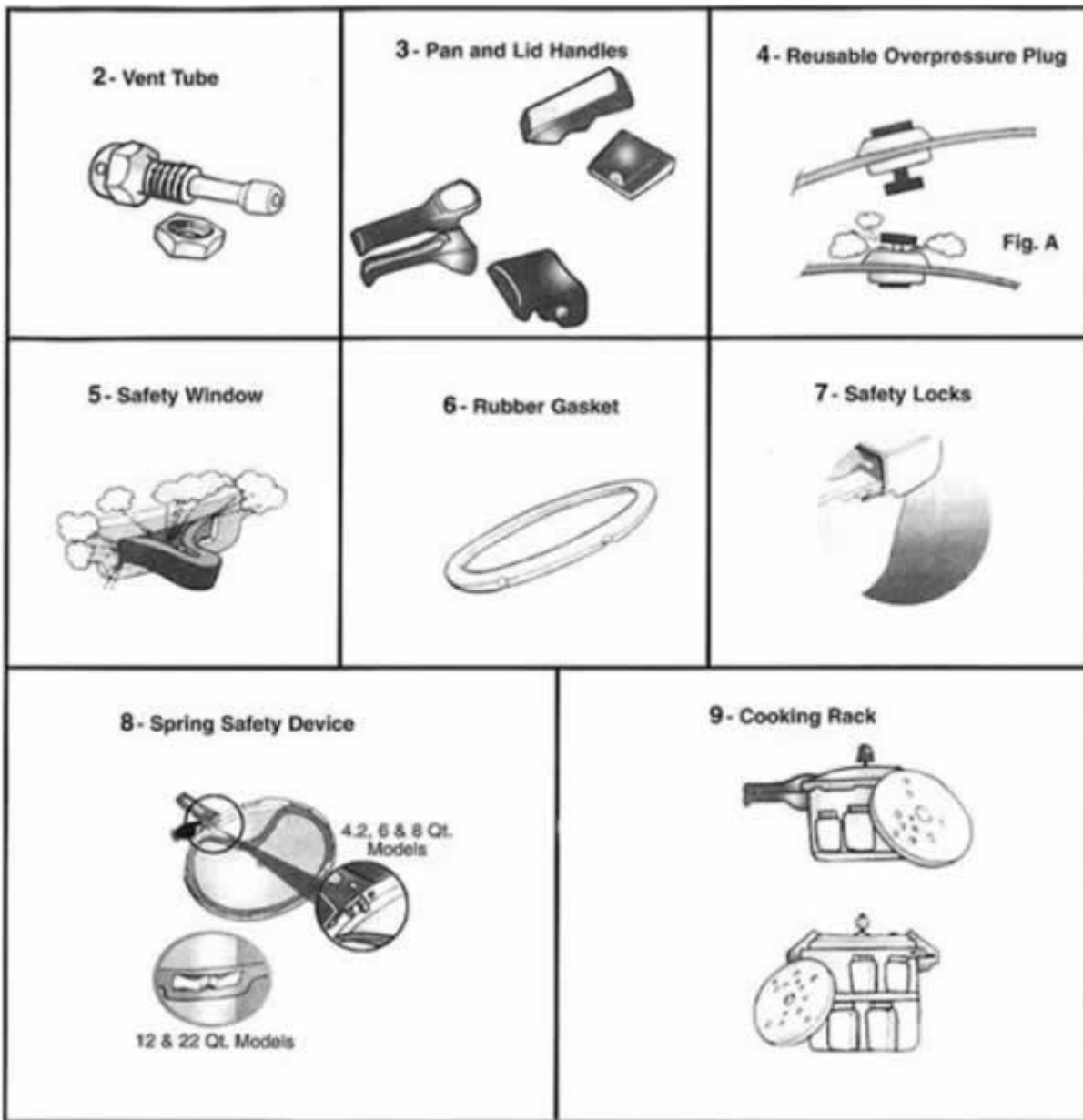

**Never Cook APPLESAUCE, CRANBERRIES, PEARL BARLEY, SPLIT PEAS, RHUBARB, NOODLES, MACARONI, SPAGHETTI or OTHER PASTA, OATMEAL or OTHER CEREALS in a Pressure Cooker.**

# How to use your Pressure Cooker

**VENT TUBE CHECK** Pick up the lid of your Pressure Cooker remove the Pressure Control and hold the lid against the light to verify if the Vent Tube is clear. In the event it is blocked, clean it with a wire along with all other holes located inside the cover. Look again against the light to make sure that it is clean. After cleaning, place Pressure Control on top of Vent Tube.

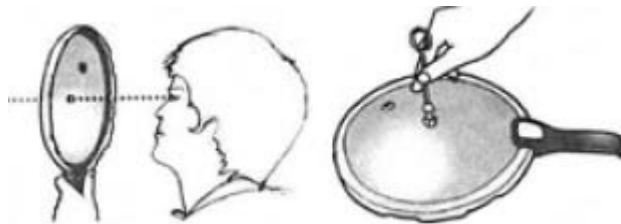

**FILLING** Fill the cooker with food and add the required amount of water. Make sure the quantity of food and water is correct. Never fill the cooker more than 1/2 full of foods that puff up like rice and dried vegetables. For all other foods, never fill more than 2/3 full.

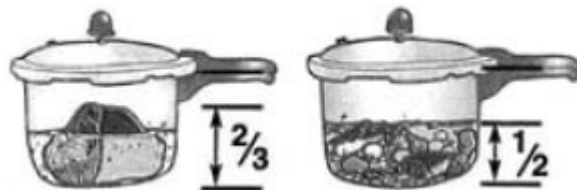

**COOKING** Place the cooker on high heat until the Pressure Control begins to release steam. The Pressure Control will rock or jiggle when the cooker reaches its pressure. Lower the heat so that the pressure control rocks gently. Generally a setting of 'medium' or 'low' will be right. Count cooking time from the first jiggle of the Pressure Control. See Cooking Time Table, page 14 for approximate cooking times.



**Caution:** Never beat a spoon or other utensil on the rim of the pan. Any denting of the rim can prevent a good gasket seal causing steam leakage.

**FOOD REMOVAL** When cooking is done, turn heat off and reduce the pressure. Do not remove the Pressure Control until pressure is completely reduced.

**YOU CAN REDUCE PRESSURE THREE WAYS:**

1. **fast** - *for fresh vegetables and fish*  
Run cold water over the cooker (Fig. A), or place it in a pan of cold water. Depending on the amount of food in the cooker, it will take 15-60 seconds for the pressure to go down fully.
2. **normally** - *for canning*  
Let the cooker cool slowly to room temperature. This will take 30-40 minutes for a small cooker, 45-60 minutes for the largest canner.
3. **combination** - *for meats and dried vegetables*  
Let the cooker cool normally at room temperature for 5 min, then place the cooker under cold water to reduce the remaining pressure.



As the pressure is reduced, air will re-enter the cooker and you will hear a hissing or squealing sound. After you have cooled the cooker, raise the Pressure Control with a fork (Fig. B) to make sure the pressure is down and if it is, remove the pressure control. If steam escapes, the pressure is not down. Continue to cool the cooker with cold water until the pressure is down. Open the cover by turning the cover counter clockwise until the OPEN-CLOSE arrow points to the center of the pan handle. When pressure is down cover should turn easily. **Warning: Never tug or force the cover open. Pressure may not be down. Continue to cool cooker.**

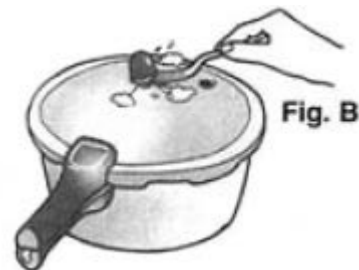

# Steam Leakage

**STEAM ESCAPE THROUGH THE VENT TUBE** The movement (jiggling) of the pressure control and release of small amounts of steam from the Vent Tube during cooking is normal. The purpose of releasing steam is to maintain a constant internal pressure. The formation of water droplets around the Vent Tube at the start of cooking is normal. This is caused by condensation of the steam leaving the cooker and coming in contact with the cooler metal. After the lid heats up, the water will disappear.

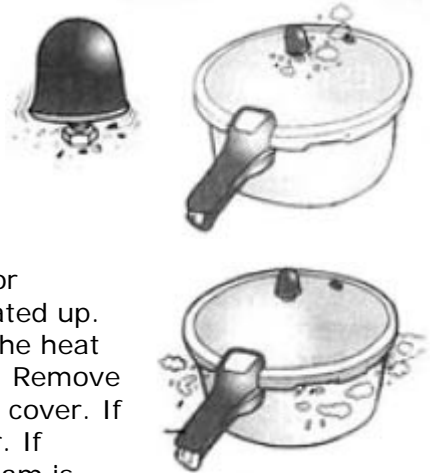

**STEAM ESCAPE AROUND RIM OF LID** Water trapped inside the handle or between the gasket and cover will escape as steam when the cooker is heated up. The steam should stop as the pressure builds up. If it does not stop, turn the heat off and cool the cooker. Remove the pressure control and open the cooker. Remove the gasket from the lid and wipe dry the gasket, pan rim, and inside of the cover. If the gasket has shrunk from its original size gently stretch it and start over. If the gasket continues to leak, replace it. Do not use your Pressure Cooker if steam is constantly leaking from the rim of the lid.

**STEAM ESCAPES THROUGH THE REUSABLE OVERPRESSURE PLUG OR SAFETY WINDOW** Consult Safety Systems.

## How to Clean your Pressure Cooker

Before using your Pressure Cooker for the first time, wash it thoroughly in hot soapy water. Rinse thoroughly and dry.

**INTERIOR** To make cleaning easier, run warm water into your after removing food. Wash in hot, soapy water. Rinse thoroughly and

**EXTERIOR** Do not soak cover or pan in water or wash in the will dull the outside polished finish. Clean the exterior occasionally. The outside bottom of the pan may be scoured with a steel wool pad



cooker immediately dry.

dishwasher, as this with silver polish. if necessary.

**GASKET** After each use, remove the gasket from the lid. Wash in hot, soapy water. Rinse and dry. Then slip the gasket back in place in the cover.

**VENT TUBE** Clean and check the vent tube as described in Vent Tube Check

**PRESSURE CONTROL** The pressure control should remain clean because it is 'steam cleaned' during use. However, washing it in hot soapy water and rinsing will not harm it.



**STORAGE** Store cooker with the lid off or upside down on cooker. DO not store with cover and gasket closed tight on pan.

**SPRING SAFETY** After each use, clean the spring safety device with hot soapy water and rinse. Also, check the function of the safety device as described on 'SPRING SAFETY DEVICE'.

# Safety Systems

**YOUR PRESSURE COOKER COMES WITH FOUR SAFETY SYSTEMS ESPECIALLY DEVELOPED FOR YOUR PROTECTION. READ CAREFULLY.**

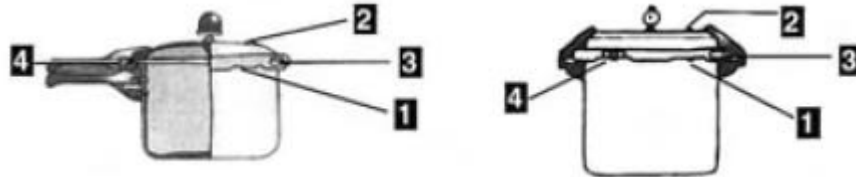

1. **SAFETY LOCKS** The locks prevent opening the cooker while under pressure. **Never force the cover to open.** Make sure the pressure is down by cooling the cooker under cold water. With the pressure down the cover will turn open smoothly.
2. **REUSEABLE OVERPRESSURE PLUG** This device is activated when the Vent Tube becomes plugged and excessive pressure builds in the cooker. If you follow the directions for using the cooker the Overpressure Plug will probably never release. However, when activated the red center pin will move upward releasing steam (Fig. A). **Keep your head and face away from cooker.** To resume cooking, turn off the heat, cool the cooker and open. Remove the Pressure Control and clean all vent tube holes. Perform Vent Tube Check and review Filling Instructions. Reset the red center pin by pushing the pin down (Fig. B). If the Overpressure Plug is leaking, with vent tube clear, replace it.

To remove a damaged Overpressure Plug, remove red pin and push on the black part of the valve from the top or outside of the lid. Clean the hole in the cover with hot soapy water and rinse. To replace, push pointed end of valve through the underside of the cover. The word "INSIDE" will be visible from the underside of the cover when correctly installed (Fig. C).

3. **OVERPRESSURE WINDOW** This feature is designed to operate when both the Vent Tube and Over Pressure Plug are blocked. Excessive pressure will force the gasket out of the window and release steam. If this should happen, turn off heat and cool your cooker with cold water and open the lid. Remove the Pressure Control and clean all vent tube holes. Perform Vent Tube Check and review Filling Instructions. Clean the Overpressure Plug with hot soapy water and rinse. **Do not reuse the gasket; replace it.**
4. **SPRING SAFETY DEVICE**
  - a. **(4.2, 6 & 8 Qt. Models)**

Located inside the lid handle the spring safety pin pushes on the gasket to prevent the cooker from being pressurized before the lid is closed. **The lid is closed when the lid handle is directly above the pan handle. Never cook with the lid in any other position. Improper closure can cause the lid to be thrown from the pan.** To check the spring compression, push on the pin with your finger to depress it and slide your finger off. The pin should snap back to its original position. If the pin does not snap back or is stuck, broken or missing you must replace the lid handle.

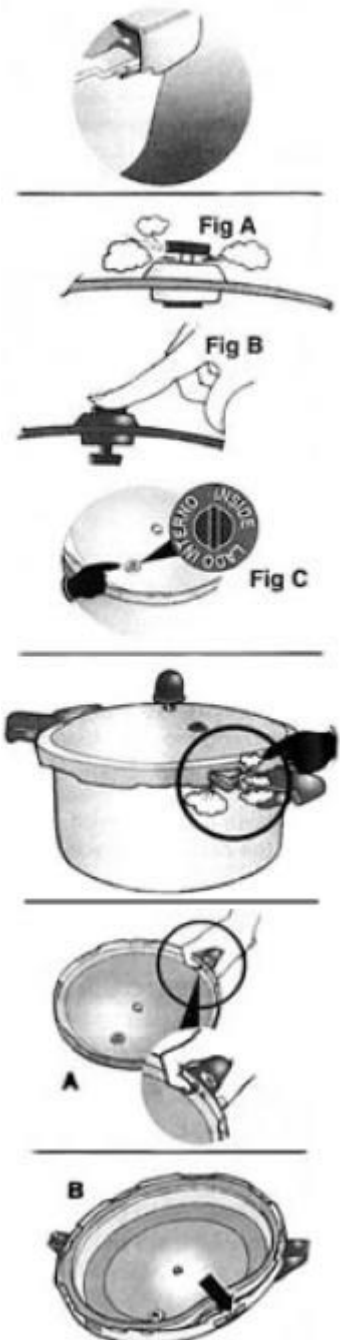



b. (12 & 22 Qt. Models)

Located on the outside of the lid, the spring safety pushed on the gasket to prevent the cooker from being pressurized before the lid is closed. **The lid is closed when the lid handle is directly above the pan handle. Never cook with the lid in any other position. Improper closure can cause the lid to be thrown from the pan.** If the spring is loose, damaged or not longer presses the gasket away from the edge of the cover, replace it before use. First remove the gasket and, using a flat screwdriver, push on either end of the spring to remove from slot. Fig. D. Remove the spring and clean the area. Fig. E.



Fig. D



Fig. E



Fig. F



Fig. G

Place the new spring from the outside of the lid by pushing one end of the new spring into the slot. Next press on the side with your thumb and finger as shown in Fig. F and snap the other end of the spring in the remaining slot. Check to make sure the spring is set by pressing from the outside with your thumbs as shown in Fig. G

**RUBBER GASKET** The gasket inside the lid seals the lid when the cooker is closed according to the directions. After a long period of use, the gasket may become hard or shrink losing its sealing ability. Gently stretch gasket and test it. If it continues to leak, replace it.



## REPLACEMENT PARTS



**WARNING: Always use genuine replacement parts. The use of parts not manufactured by MIRRO/ KitchenPro can cause injury!**

# IDENTIFY YOUR PRESSURE COOKER

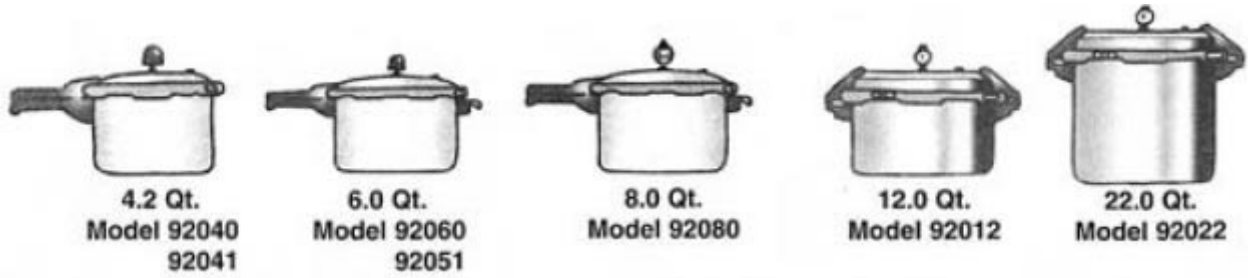

The stamp on the bottom of your pressure cooker/ canner identifies your product.  
This example is for the (4.2 Qt.) Model.

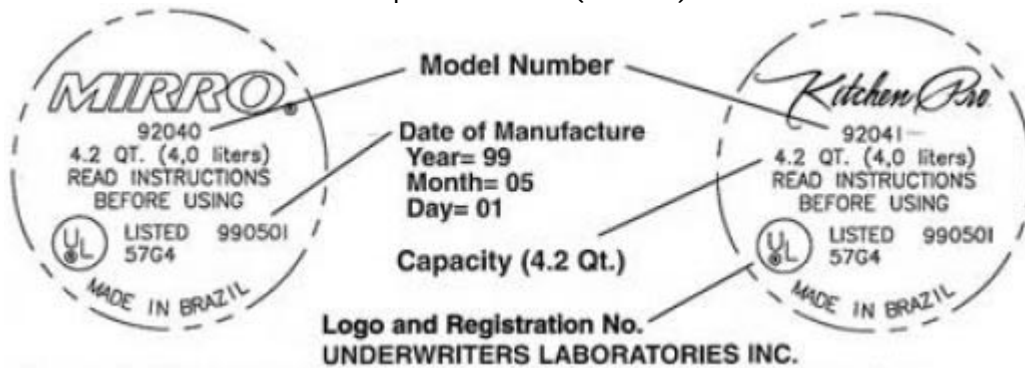

Write down the capacity of your cooker, model number and date of manufacture. This information is important for the warranty and replacement parts.

Quarts	Model	Date of Manufacture

# Ten Year Limited Warranty

## Our Promise to You:

This Mirro Company product is warranted against defects in workmanship and material for a period of **TEN YEARS** from the date that the product is originally purchased. If this product becomes defective within the warranty period, Mirro will repair it or replace it.

This warranty is not applicable to the **gasket and reusable overpressure plug** or damage to the product resulting from misuse, accidents or alterations to the product. **MIRRO SHALL NOT BE LIABLE FOR INCIDENTAL OR CONSEQUENTIAL DAMAGES, HOWEVER CAUSED.** Some states do not allow the inclusion or limitation of incidental or consequential damages, so the above exclusions may not apply to you.

If service becomes necessary within the warranty period, return the product, postage paid (by you), along with description of the claimed defect, to:

**MIRRO COMPANY  
ATTN: Consumer Center  
1512 Washington Street  
P.O. Box 1330  
Manitowoc, WI 54221-1330**

Mirro will refund the postage and insurance charges, if any, you prepaid if the service work requested is covered by the warranty.

This warranty gives you specific legal rights and you may also have other rights which vary from state to state.

**Comments, Questions, Concerns? Call Our Customer Center at 1-800-527-7727**

## Questions and Answers

### **HOW DOES THE PRESSURE COOKER WORK?**

The Pressure cooker produces pressure by heating water thereby generating steam (similar to the steam that raises the lid of your conventional cooker). The Pressure Cooker keeps the steam inside, allowing the excess to escape through the Vent Tube. The Pressure Control automatically maintains a constant internal pressure.

### **IF I USE HIGH HEAT WILL THE FOOD COOK FASTER?**

No. Using high heat for cooking will only waste energy and result in excessive loss of cooking liquid (water). However you must use high heat to initially bring cooker up to pressure.

### **WHY DOES STEAM ESCAPE FROM THE REUSEABLE OVERPRESSURE PLUG AT THE BEGINNING OF THE OPERATION?**

At the start of cooking the internal pressure is low and not sufficient to activate the red center pin of the

Overpressure Plug. The purpose of this is to eliminate the cold air inside the cooker at the start of cooking. However, if during cooking, steam continues to escape, make sure the Overpressure Plug is clean and the red center pin is in the correct position. Remember to only open your cooker when the pressure is down. If the Overpressure Plug continues to leak replace it with a new one.

#### **WHEN SHOULD I REPLACE THE RUBBER GASKET?**

The lifespan of your Rubber gasket depends on the type of food and how frequently you use your Pressure Cooker. If you notice steam escaping between the body and the lid (as long as the gasket and lid are clean and properly installed), stretch the Rubber Gasket slightly and test it again. Should the leakage continue, replace it with a new and original one.

#### **WHAT SHOULD I DO IF, DURING COOKING, STEAM STOPS COMING OUT OF THE VENT TUBE?**

Turn off the heat and wait while your Pressure Cooker cools to room temperature. Open it and remove the Pressure Control, check the Vent Tube against the light and clean it with wire, check the level of food and water (if in excess remove part of it), close the lid correctly, replace the Pressure Control and resume cooking.

#### **WHAT MAKES THE RUBBER GASKET STRETCH, SHRINK, SWELL OR STIFFEN?**

The stretching or 'swelling' may occur when there is accumulation of grease from the food or excessive oiling. Wash it thoroughly after each use. Stiffness or shrinkage is caused by pressure, heat and age. If this occurs, replace with a new one.

#### **WHEN COOLING MY PRESSURE COOKER UNDER THE WATER TAP, IT WHISTLES; IS THIS DANGEROUS?**

While being cooled under water, initial pressure is quickly reduced producing a vacuum. The whistle is produced by the incoming air. This is normal and not dangerous.

#### **WHAT MAKES THE COOKER LID HARD TO CLOSE?**

In a new cooker, the gasket is dry and often very snug fitting. Pressing down on the cover with one hand, while you close the cooker with the other will often help. You may lubricate the gasket with cooking oil or shortening for the first two or three uses. Caution: Excessive lubrication will cause the gasket to swell and not fit properly.

#### **HOW DO I KNOW WHEN THE PRESSURE COOKER IS OPERATING CORRECTLY?**

As long as the cooker lid is closed, that is lid handle directly over pan handle and the Pressure Control is gently rocking or jiggling you can be sure the cooker is maintaining the proper internal pressure. The Pressure Cooker never need to be tested or adjusted for accuracy.

## **COOKING TIMETABLES**

### **How to Adapt Your Own Recipes to Pressure Cooking**

The recipes in this book are only a start; most foods that can be boiled, steamed, or braised are suitable for pressure cooking. By following a few simple guidelines, you can adapt your favorite recipes for pressure cooking.

1. Use the timetables and recipes in this book to determine pressure, cooking time, amount of liquid, and cooling method for use in your own recipes.
2. you may use other liquids such as wine, beer, broth, tomato juice, etc. in place of an equal amount of water, but **do not use milk or milk products** as they boil over and scorch easily.
3. You may cook different foods together. If they require different cooking times, just start the food with the longest cooking time first, and add the others later; as in conventional cooking.

# MEAT and POULTRY TIMETABLE

This pressure cooker is ideal for tenderizing the less tender cuts of meat. Most meats (except corned beef, salt pork and tongue) should be browned in hot fat in the uncovered cooker before pressure cooking. Cooking time may vary depending upon cut, grade, amount of bone, etc., and may be adjusted to suit your taste. Time is given as a total rather than minutes per pound.

FOR ALL MEAT AND POULTRY COOL COOKER NORMALLY FOR 5 MINUTES, THEN PLACE UNDER FAUCET OR IN A PAN OF COLD WATER TO REDUCE PRESSURE.

Amount of Liquid		Meat and Poultry	Minutes To Cook	
4.2 Qt. Cooker	6/8 Qt. Cooker		at 10 Lbs.	at 15 Lbs.
6 cups	8 cups	<b>Beef, Corned</b> - 3-4 in. thick. Follow pkg. directions for preparation for cooking.	60	45
1 1/2 cups	2 cups	<b>Beef Flank Steak</b>	45	35
3 cups	4 cups	<b>Beef Heart</b> - Remove veins. Cover with salted water 1/2 hr. Drain. Add fresh water and 1/4 cup vinegar. Cook.	60	45
2 cups	2 1/2 cups	<b>Beef Liver</b> - Slice. Cook on rack.	6	5
2 cups	2 1/2 cups	<b>Beef Pot Roast (blade, chuck or rump)</b> - 2-3 in. thick.	40-50	30-40
2 cups	2 1/2 cups	<b>Beef Round Steak (Swiss)</b> - 1/2 in.	25-30	20-25
2 cups	2 1/2 cups	<b>Beef Short Ribs</b>	45-50	35-40
3 cups	3 1/2 cups	<b>Beef Stew</b> - 1 in. pieces	20-25	15-20
4 cups	5 cups	<b>Beef Tongue</b>	60	45
		<b>Fresh or smoked</b> - Cook. Cool in cooking liquid. Skin. <b>Cured (corned)</b> - Cover with water several hrs. Drain. Cook. Cool in cooking liquid. Skin		
2 cups	2 1/2	<b>Chicken (fried)</b> 2 1/2 -3 lbs.	15	12
3 cups	4 cups	<b>Chicken (fricasseed)</b> -3-4 lbs.	20-25	15-20
3 cups	4 cups	<b>Chicken (stewed)</b> - 4-5 lbs.	30-40	25-30
4 cups	5 cups	<b>Ham (shank, uncooked)</b> - 3-5 lbs.	45-60	35-45
4 cups	5 cups	<b>Ham (picnic shoulder, uncooked)</b> - 3-6 lbs.	45-60	35-45
1 cup	1 1/2 cups	<b>Ham (slices, uncooked)</b> - 1/2 in. slice	6-8	5-6
1 cup	1 1/2 cups	1 in. (2.5 cm) slice	12-14	9-12
1 1/2 cups	2 cups	2 in. (5 cm) slice	18-25	12-20
3 cups	6 cups	<b>Lamb Shoulder</b> - 3-6 lbs.	45-60	35-45
1 cup	1 1/2 cups	<b>Lamb Steak</b> - 1/2 in. thick	12	9
3 cups	4 cups	<b>Lamb Stew</b> 1 in. pieces	15	10
4 cups	5 cups	<b>Mutton (boiled)</b> - 4-6 lbs.	60	45
3 cups	4 cups	<b>Oxtails</b>	60	45
1 1/2 cups	2 cups	<b>Partridge</b>	15	12
2 cups	2 1/2 cups	<b>Pheasant</b>	20-25	15-20
1 1/2 cups	2 cups	<b>Pork Chops</b>	12	9
4 cups	5 cups	<b>Pork Shanks</b>	45	35
2 1/2 cups	3 cups	<b>Pork Shoulder</b> - 2 1/2 in. thick	45-50	35-40
1 1/2 cups	2 cups	<b>Pork Spareribs</b>	20	15
1 1/2 cups	2 cups	<b>Rabbit</b>	18-20	12-15
2 cups	2 1/2 cups	<b>Squirrel</b>	25-30	20-25
		<b>Turkey (Same as chicken)</b>		
3 cups	4 cups	<b>Veal Heart</b>	45	35
4 cups	5 cups	<b>Veal Shank</b>	50-60	40-45
1 cup	2 cups	<b>Veal Steak</b> - 1/2 in. thick	18-20	12-15
3 cups	4 cups	<b>Veal Stew</b> - 1 in. pieces	15	10
3 cups	4 cups	<b>Veal Tongue</b> - See Beef Tongue (above)	30	25
2 cups	2 1/2 cups	<b>Venison Pot Roast</b> - 3-4 in. thick	40-50	30-40

# FISH and SEAFOOD TIMETABLE

FOR ALL FISH AND SEAFOOD, REDUCE PRESSURE INSTANTLY BY PLACING COOKER UNDER COLD WATER (FAUCET).

Amount of Liquid		Fish and Seafood	Minutes to Cook	
4.2 Qt. Cooker	6/8 Qt. Cooker		at 10 Lbs.	at 15 Lbs.
1 cup	2 cup	<b>Fish Steaks</b> - 3/4 in. thick. Season with salt and pepper. Dip in flour. Brown in hot shortening in cooker. Place Steaks on rack. Add water. Cover and cook.	4-6	3-5
1 cup	2 cup	<b>Steamed Fish</b> - 3/4 in. thick. Place water, sliced onion, bay leaf and parsley in cooker. Season fish and place on rack in cooker. Cover and cook.	3-5	2-4
3 cups	6 cups	<b>Finnan Haddie (Salt Cod)</b> - Cover with water and let stand 1 hour. Drain. Place in cooker with water. Cover and cook. Flake fish and discard skin. Serve with white sauce.	8	6
3 cups	6 cups	<b>Shrimp</b> - Wash shrimp. Place in cooker with water and lemon slice. Cover and cook. Drain. Cover with cold water. Shell and clean.	4-6	3-5
3 cups	6 cups	<b>Lobster Tail</b> - Wash lobster tails. Place in cooker with water and salt. Cover and cook. Plunge lobster tails in cold water and remove shells.	6-8	5-6
3 cups	6 cups	<b>Clams</b> - Wash clams thoroughly in salted water, using a brush to scrub the shells. Cover clams with cold water and salt. Cover and cook. Strained clam liquid can be used in clam chowder.		

# FRESH VEGETABLE TIMETABLE

Compared with other cooking methods, many fresh vegetables require only about one third of the cooking time. The timetable is a good guide, but can only approximate because of the variation in age and type of each food. Quantity of water shown in chart should be used regardless of whether a cupful or a pan full is to be cooked. Be sure to reduce pressure instantly to prevent overcooking. If vegetables are wilted, soak for a few minutes to restore moisture. They may be seasoned either before or after cooking.

Those vegetables that have similar cooking times may be cooked together in the cooker and flavors will not mingle. If desired, vegetables may be placed in individual metal or heatproof containers and placed on rack with water in bottom of cooker. Or, form containers of a double thickness of household aluminum foil pressed over inverted bowl or can. When cooking in such individual containers, leave containers uncovered and increase cooking time slightly.

Follow [general directions for operation](#) of cooker.

It is not necessary to use the rack unless specified, but if you prefer to do so, add an extra 1/4 cup of water.

To drain cooking water from vegetables, remove cover after pressure is reduced, slip out gasket, replace cover without gasket and you have a perfect drainer. Food cannot slip out because the cover is locked on. FOR ALL VEGETABLES, REDUCE PRESSURE BY PLACING SOOKER UNDER COLD WATER (FAUCET).

Amount of Liquid		Fresh Vegetables	Minutes to Cook at 10 Lbs.
4.2 Qt. Cooker	6/8 Qt. Cooker		
2 cups	2 1/2 cups	<b>Artichoke</b> - Wash, cut off tops and ties ends to hold shape.	15
1 cup	1 1/2 cups	<b>Asparagus</b> - Snap off tough ends. Remove scales. Wash.	2-2 1/2
1 cup	1 1/2 cups	<b>Beans, Green or Wax</b> - Wash and cut.	2-3
1 cup	1 1/2 cups	Beans, Lima (fresh)- Shell and wash.	2
1 1/2 cups	2 cups	<b>Beets (small whole)</b> - cut tops, leaving 1 in. stem and root. Wash. Cook. Cool. Remove skin. Reheat for serving.	12
2 cups	3 cups	<b>Beets (large, whole)</b> - Same as small, whole beets above.	18
1 cup	1 1/2 cups	<b>Broccoli</b> - Remove large outer leaves. Cut off tough part of stalk. Cut into strips. Wash.	2-2 1/2
1 1/2 cups	2 cups	<b>Brussels Sprouts</b> - Wash.	5
1 1/2 cups	2 cups	<b>Cabbage (shredded)</b> - Remove wilted outer leaves. Quarter cabbage and shred into thin strips.	2-3
1 1/2 cups	2 cups	<b>Cabbage (wedges)</b> - use medium size head. Cut in 2 or 3 in. wedges. Remove core.	5-8
1 1/2 cups	2 cups	<b>Cabbage, Red (shredded)</b> - Remove wilted outer leaves. Quarter cabbage and shred into thin strips.	5
1/2 cup	1 cup	<b>Carrots (sliced)</b> - Wash and scrape. Slice or cut in strips.	2 1/2
1/2 cup	1 cup	<b>Carrots (small whole)</b> - Wash and scrape.	4
1 cup	1 1/2 cups	<b>Cauliflower (flowerets)</b> - Cut off stem and leaves. Break into large flowerets. Wash.	2-3
2 cups	2 1/2 cups	<b>Cauliflower (whole)</b> - Cut off stem and leaves. Remove center core, leaving only enough to keep flowerets from falling off. Cook on rack.	6-8
1 cup	1 1/2 cups	<b>Celery</b> - Separate stalks. Wash well. With a knife, pull off tough fibres. Slice.	3-5
2 cups	2 1/2 cups	<b>Corn (on the cob)</b> - Remove husks and silk. Wash. Cook on rack.	5
1 cup	1 1/2 cups	<b>Corn (whole kernel)</b> - Remove husks and silk. Wash. Cut off cob.	3
1 cup	1 1/2 cups	<b>Egg Plant</b> - Wash, pare and cut into 1/2 or 1 in. cubes. Cook at once to prevent discoloration.	3
1 cup	1 1/2 cups	<b>Kale or Collards</b> - Wash well in several waters. Remove tough veins and cut into 2 in. pieces.	4-6
1 cup	1 1/2 cups	<b>Kohlrabi</b> - Wash and peel. cut into 1/2 in. slices or 1 in. pieces.	4

1 cup	1 1/2 cups	<b>Okra</b> - Cut off ends and wash. Cut into 1/2 in. pieces.	3
1 cup	1 1/2 cups	<b>Onions (sliced)</b> - Peel and slice.	3
1 1/2 cups	2 cups	<b>Onions (whole medium)</b> - Peel.	7-10
1 cup	1 1/2 cups	<b>Parsnips (sliced)</b> - Peel, wash and cut into 1/2 in. slice.	2
1 1/2 cups	2 cups	<b>Parsnips (halves)</b> - Peel, wash and cut in halves. Cook on rack.	7
1 cup	1 1/2 cups	<b>Peas</b> - Shell and wash.	2-3
2 cups	2 1/2 cups	<b>Potatoes (sliced)</b> - Scrub peel and slice.	2 1/2
3 cups	4 cups	<b>Potatoes (medium, cut in halves)</b> - Scrub, peel and cut in halves. Cook on rack.	8
3 cups	4 cups	<b>Potatoes (medium, whole)</b> - Scrub. Cook peeled or unpeeled. Cook on rack.	12-15
2 cups	3 cups	<b>Potatoes, Sweet or Yams (quartered)</b> - Wash, peel and quarter. Cook on rack.	6
2 cups	3 cups	<b>Potatoes, Sweet or Yams (halved)</b> - Wash, peel and cut in halves lengthwise. Cook on rack.	8-10
2 1/2 cups	3 cups	<b>Pumpkin</b> - Cut in large pieces. Wash. Cook. Remove pulp and mash.	8-10
1 1/2 cups	2 cups	<b>Rutabagas and Turnips</b> - peel and wash. Cut into 1/2 in. cubes or slices.	5
1 cup	1 1/2 cups	<b>Sauerkraut</b>	12
1 cup	1 1/2 cups	<b>Spinach, Swiss Chard or Other Greens</b> - Wash thoroughly in several waters.	1
1 1/2 cups	2 cups	<b>Squash, Acorn</b> - Wash. Cut in half and remove seeds. Cook on rack.	6-7
1 1/2 cups	2 cups	<b>Squash, Hubbard</b> - Wash. Remove seeds. Cut in pieces. Cook on rack.	8-10
1 1/2 cups	2 cups	<b>Squash, Summer or Zucchini</b> - Wash. Cut in pieces or slice. Cook on rack.	2-3
1/2 cup	1 cup	<b>Tomatoes</b> - Scald 1 min. Dip in cold water and peel.	2 1/2
1 1/2 cups	2 cups	<b>Turnips</b> - Peel and wash. Cut into 1/2 in. cubes or slices.	5



# DRIED VEGETABLE TIMETABLE

Heat beans (not black eyed peas or lentils) and water (2 cups water for 1 cup beans) to boiling in cooker; boil 2 minutes remove from heat; cover and let stand 1 hour. Drain; add necessary water. ADD 1 TABLESPOON VEGETABLE OIL TO PREVENT FROTHING. Bring up to pressure on high heat. Cook as directed.

Alternate Method: Soak beans overnight in water to cover. Drain; add water and oil. bring up to pressure on high heat. Cook as directed.

FOR ALL DRIED VEGETABLES, COOL COOKER NORMALLY FOR 5 MINS, THEN PLACE UNDER FAUCET.

Amount of Liquid for 1 cup Vegetables		Dried Vegetables	Minutes to Cook at 10 Lbs.
4.2 Qt. Cooker	6/8 Qt. Cooker		
3 cups	4 cups	<b>Black-eyed Peas</b>	10
4 cups	5 cups	<b>Great Northern Beans</b>	20
4 cups	5 cups	<b>Kidney Beans</b>	30
4 cups	5 cups	<b>Lentils</b>	20
4 cups	5 cups	<b>Lima Beans, large</b>	30
4 cups	5 cups	<b>Lima Beans, small</b>	25
4 cups	5 cups	<b>Navy Beans (Chick-Pea)</b>	30
4 cups	5 cups	<b>Pea Beans</b>	20
4 cups	5 cups	<b>Pinto Beans</b>	10
4 cups	5 cups	<b>Soybeans</b>	35

## WARNING:

**DRIED VEGETABLES WILL EXPAND OR PUFF-UP DURING COOKING.**

**NEVER FILL COOKER MORE THAN 1/2 FULL.**

**OVERFILLING CAN PLUG VENT TUBE AND CAUSE RELEASE OF STEAM.**

# RECIPES - Beef

## Barbequed Beef Short Ribs

4.2 Qt.	6/8 Qt.	Ingredients
3 lbs	6 lbs	Beef Short Ribs
2 Tbsp	3 Tbsp	Bacon Drippings
2 Tbsp	1/4 cup	Onion, sliced
1 Tbsp	2 Tbsp	Green Pepper, chopped
1 cup	2 cups	Catsup
1 tsp	2 tsp	Salt
1 tsp	2 tsp	Celery Seed
2 Tbsp	1/4 cup	Brown Sugar
2 Tbsp	1/4 cup	Lemon Juice
2 tsp	1 Tbsp	Dry Mustard
2 cup	3 1/2 cup	Water
<b>4 servings</b>	<b>8 servings</b>	

1. Brown short ribs in dripping in pressure pan. Pour off excess fat.
2. Mix remaining ingredients together and pour over meat.
3. Cover, set control at 10 PSI and cook 40-50 minutes after control jiggles.
4. Cool pan normally for 5 minutes, then place under faucet.
5. Thicken sauce with 1 tablespoon flour mixed with 1/4 cup water for each cup of sauce.

## Porcupine Meat Balls

4.2 Qt.	6/8 Qt.	Ingredients
1 lb	2 lbs	Ground Beef
1/2 cup	1 cup	Uncooked Rice
1 Tbsp	2 Tbsp	Onion, minced
1 tsp	2 tsp	Salt
1/4 tsp	1/2 tsp	Pepper
1 10 1/oz. can	2 10 1/2 oz. cans	Tomato Soup
1 cup	1 1/2 cups	Water
<b>Serves 4</b>	<b>Serves 8</b>	

1. Combine meat, rice, onion, salt and pepper. Form into balls.
2. Mix soup and water in pressure pan.
3. Drop meat balls in pan. Cover, set control at 10 PSI and cook 10 minutes after control jiggles. Cool pan normally for 5 minutes, then place under faucet.

## Beef Stew

4.2 Qt.	6/8 Qt.	Ingredients
1 1/2 lbs.	3 lbs.	Beefs Stew Meat - 1 inch pieces
1 Tbsp	2 Tbsp	Fat
1 tsp	2 tsp	Salt
Dash	1/4 tsp	Pepper
1/4 tsp	1/2 tsp	Paprika
3 cups	3 1/2 cups	Water
1/2 cup	1 cup	Onions, chopped
4	8	Carrots, whole
4	8	Potatoes, medium, cut in halves
<b>4-6 servings</b>	<b>8-12 servings</b>	

1. Brown beef in fat in cooker. Season with salt, pepper and paprika. Add water
2. Cover, set control at 10 PSI and cook 15 minutes after control jiggles.
3. Cool cooker normally for 5 minutes, then place under faucet. Add remaining ingredients.
4. Cover, set control at 10 PSI and cook 10 minutes after control jiggles. Reduce pressure instantly.

## Beef Pot Roast

4.2 Qt.	6/8 Qt.	Ingredients
2 lbs.	4 lbs.	Beef Pot Roast 2-3 in. thick
1 Tbsp	2 Tbsp	Fat
1 1/2 tsp	1 Tbsp	Salt
1/4 tsp	1/2 tsp	Pepper
2	4	Onions, medium, sliced
2 cups	2 1/2 cups	Water
<b>4-5 servings</b>	<b>8-10 servings</b>	

1. Brown beef in fat in cooker
2. Season with salt and pepper. Add onions and water.
3. Cover, set control at 10 PSI and cook 45-60 minutes after control jiggles.
4. Cool cooker normally for 5 minutes, then place under faucet. Prepare gravy recipe.

## Flank Steak with Dressing

4.2 Qt.	6/8 Qt.	Ingredients
1 steak	2 steaks	Flank Steak (2 lbs.)
<b>Dressing:</b>		
3/4 cup	1 1/2 cups	Sausage Meat
1 apple	2 apples	Apple, peeled and sliced
1 1/2 cups	3 cups	Dried bread crumbs
1 Tbsp	2 Tbsp	Onion, minced
1/4 tsp	1/2 tsp	Salt
3 Tbsp	6 Tbsp	Fat
1 1/2 cups	2 cups	Water
<b>Serves 4</b>	<b>Serves 8</b>	

1. Heat sausage meat in fry pan. Pour off excess fat.
2. Add other ingredients.
3. Trim edges of steak and sprinkle salt and pepper on.
4. Spread dressing over flank steak, roll up loosely and tie it securely.
5. Brown steak on all sides in fat in cooker
6. Add water, cover, set control at 10 PSI and cook for 45 minutes after control jiggles.
7. Cool cooker normally for 5 minutes and then place under faucet. Prepare gravy recipe.

## Braised Pepper Steak

4.2 Qt.	6/8 Qt.	Ingredients
1 (about 1 1/2 lbs.)	2 (about 3 lbs.)	Flank Steak - cut into 1/4 in. strips
2 Tbsp	1/4 cup	Fat
1 4-oz. can	2 4-oz. cans	Mushrooms
2 cups	4 cups	Water
1	2	Beef Bouillon Cube
2 Tbsp	1/4 cup	Soy Sauce
1 Tbsp	2 Tbsp	Sugar
1/4 tsp	1/2 tsp	Garlic Salt
Dash	1/4 tsp	Pepper
1	2	Green Pepper - cut in strips
1 1/2 Tbsp	3 Tbsp	Flour
1/2 cup	1 cup	Water
<b>Serves 4</b>	<b>Serves 8</b>	

1. Brown steak strips in fat in cooker (brown about a third of the strips at a time).
2. Add mushrooms, water, bouillon cube, soy sauce, garlic salt and pepper.
3. Cover, set control at 10 PSI and cook for 5 minutes after control jiggles. Reduce pressure instantly.
4. Add green pepper strips. Cover, set control at 10 PSI and cook an additional 3 minutes. Reduce pressure instantly
5. Mix flour and water together, add and cook until thickened, stirring constantly. Serve over buttered noodles.

## Chili Con Carne

4.2 Qt.	6/8 Qt.	Ingredients
1 lb.	2 lbs.	Ground Beef
1/2 cup	1 cup	Onion, chopped
1 Tbsp	2 Tbsp	Fat
1 Tbsp	2 Tbsp	Green Pepper, chopped
1 cup	2 cups	Canned Tomatoes
1 tsp	2 tsp's	Salt
1/2 tsp	1 tsp	Paprika
1-2 tsp	2-4 tsp	Chili Powder
1 1-lb. can	2 1-lb. cans	Kidney Beans, Drained (reserve liquid)
<b>4-5 servings</b>	<b>8-10 servings</b>	

1. Brown beef and onion in fat in cooker. Pour off excess fat.
2. Add remaining ingredients except kidney beans. Add enough water to reserved bean liquid to measure 3 cups. Use 6 cups for 6/8-qt. recipe. Add to cooker. Break up tomatoes.
3. Cover, set control at 10 PSI and cook 10 minutes after control jiggles.
4. Cool cooker normally for 5 minutes, then place under faucet.
5. Add kidney beans and simmer a few minutes.

## Beef Stroganoff

4.2 Qt.	6/8 Qt.	Ingredients
1 lb.	2 lbs.	Beef Stew Meat - 1 in. pieces
1 Tbsp	2 Tbsp	Flour
1 Tbsp	2 Tbsp	Fat
1 4-oz. can	2 4-oz cans	Mushrooms, drained (reserve liquid)
1	2	Onions, medium, sliced
1 tsp	2 tsp	Salt
1/4 tsp	1/2 tsp	Pepper
Dash	1/4 tsp	Ground Marjoram
3 Tbsp	6 Tbsp	Catsup
1/2 cup	1 cup	Dairy Sour Cream
<b>4 servings</b>	<b>8 servings</b>	

1. Roll beef in flour. Brown in hot fat in cooker.
2. Add enough water to reserved mushroom liquid to measure 1 1/2 cups. Use 3 cups for 6/8-qt. recipe. Add mushrooms, mushroom-water mixture and remaining ingredients except sour cream to cooker.
3. Cover, set control at 10 PSI and cook 15 minutes after control jiggles.
4. Cool cooker normally for 5 minutes, then place under faucet
5. Stir in sour cream; heat through. Serve with noodles.

## Hungarian Goulash

4.2 Qt.	6/8 Qt.	Ingredients
1 1/2 lbs.	3 lbs.	Beef Stew Meat, 1 in. pieces
2 Tbsp	1/4 cup	Fat
2	3	Onions, medium, sliced
1 tsp	2 tsp	Salt
1/4 tsp	1/2 tsp	Pepper
1/2 tsp	1 tsp	Paprika
1/2	1	Bay Leaf
1/2 tsp	1 tsp	Ground Marjoram
3 cups	6 cups	Water
4	8	Potatoes, medium, whole
4	8	Carrots, medium, cut lengthwise
2	4	Turnips, cut in halves
1 cup	2 cups	Green Pepper, chopped
<b>4-6 servings</b>	<b>8-12 servings</b>	

1. Brown beef in fat in cooker.
2. Add onions, salt, pepper, paprika, bay leaf, marjoram and water.
3. Cover, set control at 10 PSI and cook 15 minutes after control jiggles.
4. Cool cooker normally for 5 minutes, then place under faucet.
5. Place remaining ingredients on rack over beef.
6. Cover, set control at 10 PSI and cook 10 minutes after control jiggles. Reduce pressure instantly
7. Prepare gravy recipe.

## Corned Beef and Cabbage

4.2 Qt.	6/8 Qt.	Ingredients
2 lbs.	4 lbs.	Corned Beef Brisket
3 cups	4 cups	Water
4	8	Carrots
4	6	Potatoes, medium, cut in halves
4	8	Cabbage wedges
4	8	Onions, small, whole
<b>4 servings</b>	<b>8 servings</b>	

1. Place corned beef in cooker. Add water
2. Cover, set control at 10 PSI and cook 60 minutes after control jiggles.
3. Cool cooker normally for 5 minutes, then place under faucet.
4. Add remaining ingredients.
5. Cover, set control at 10 PSI and cook 8-10 minutes after control jiggles. Reduce pressure instantly.

### Swiss Steak with Pickled Onions

4.2 Qt.	6/8 Qt.	Ingredients
1/4 cup	1/2 cup	Flour
1 tsp	2 tsp	Salt
Dash	1/4 tsp	Pepper
1 1/2 lbs.	3 lbs.	Round Steak- 1/2 in. thick
2 Tbsp	3 Tbsp	Fat
1 10-oz. bottle	1 10-oz. bottles	Pickled Onions, drained (reserve liquid)
<b>4-6 servings</b>	<b>8-12 servings</b>	

1. Mix flour, salt and pepper.
2. Cut steak into individual servings; coat with flour mixture.
3. Brown in hot fat in cooker.
4. Add enough water to onion liquid to measure 1 1/2 cups. Use 3 cups for 6/8-qt. recipe. Add onions and onion-water mixture to cooker.
5. Cover, set control to 10 PSI and cook for 35 minutes after control jiggles.
6. Cool cooker normally for 5 minutes, then place under faucet. Prepare gravy recipe.

### Beef Vegetable Dinner

4.2 Qt.	6/8 Qt.	Ingredients
3/4 lb.	1 1/2 lbs.	Beef, Boneless Chuck, Tip or Round
1 Tbsp	2 Tbsp	Fat
1/4 cup	1/2 cup	Onion, chopped
2 Tbsp	1/4 cup	Green Pepper, chopped
1 tsp	2 tsp	Salt
1/2 tsp	1 tsp	Chili Powder
1/4 tsp	1/2 tsp	Pepper
1 1-lb can	2 1-lb cans	Whole Kernel Corn, drained (reserve liquid)
2 cup	4 cup	Corn liquid and water
1 8-oz can	2 8-oz cans	Tomato sauce
1/4 cup	1/2 cup	Catsup
1 cup	2 cups	Wide Noodles, uncooked
<b>4 servings</b>	<b>8 servings</b>	

1. Cut beef into 1 x 1/4 in. pieces. Brown in fat in cooker.
2. Add remaining ingredients and stir.
3. Cover, set control at 10 PSI and cook 5 minutes after control jiggles.
4. Cool cooker normally for 5 minutes, then place under faucet.

### Gravy

4.2 Qt.	6/8 Qt.	Ingredients
1 cup	2 cups	Broth (liquid from cooked meat)
2 Tbsp	1/4 cup	Flour
1/4 cup	1/2 cup	Cold Water

1. Skim excess fat from broth. Add enough water to broth, if necessary, to measure 1 cup. Use 2 cups for 6/8 Qt. recipe.
2. Mix flour and water until smooth. Gradually stir into broth.
3. Cook over medium heat, stirring constantly, until gravy is smooth and thickened. Season with salt and pepper.

# RECIPES - Pork

## Stuffed Pork Chops

4.2 Qt.	6/8 Qt.	Ingredients
1 1/2 cups	3 cups	Bread Cubes
1 Tbsp	2 Tbsp	Butter or Margarine
2 Tbsp	1/4 cup	Parsley, chopped
4	8	Pork Chops - 1 to 1 1/2 in. thick, with pocket cut along side of bone.
3/4 tsp	1 1/2 tsp	Salt
Dash	1/4 tsp	Pepper
1 Tbsp	2 Tbsp	Fat
1 10-oz can	1 10-oz can	Consommé
1 cup	2 cups	Water
<b>4 servings</b>	<b>8 servings</b>	

1. Brown bread cubes in butter. Mix with parsley.
2. Stuff chops with bread mixture. Season with salt and pepper.
3. Brown chops in fat in cooker.
4. Place chops on rack in cooker. Add consommé and water.
5. Cover, set control at 10 PSI and cook 12-15 minutes after control jiggles.
6. Cool cooker normally for 5 minutes, then place under faucet. Prepare gravy recipe.

## Spareribs, Sauerkraut and Potatoes

4.2 Qt	6/8 Qt.	Ingredients
2 1/2 lbs.	5 lbs.	Spareribs
1 Tbsp	2 Tbsp	Fat
1 tsp	2 tsp	Salt
Dash	1/4 tsp	Pepper
1 1-lb can	2 1-lb cans	Sauerkraut, drained
1 Tbsp	2 Tbsp	Brown Sugar
4	8	Potatoes, medium, whole
1 1/4 cups	3 cups	Water
<b>4 servings</b>	<b>8 servings</b>	

1. Brown ribs in fat in cooker. Season with salt and pepper.
2. Put sauerkraut in bottom of cooker and sprinkle with brown sugar
3. Place ribs and potatoes over sauerkraut. Add water.
4. Cover, set control at 10 PSI and cook 20 minutes after control jiggles.
5. Cool cooker normally for 5 minutes, then place under faucet.

## Scalloped Potatoes and Ham

4.2 Qt.	6/8 Qt.	Ingredients
3	3	Potatoes, medium
3 Tbsp	3 Tbsp	Flour
3/4 tsp	3/4 tsp	Salt
1/4 tsp	1/4 tsp	Pepper
1 cup	1 cup	Ham, cooked, cubed
2 Tbsp	2 Tbsp	Onion, chopped
2 Tbsp	2 Tbsp	Butter or Margarine
1 cup	1 cup	Milk
<b>4 servings</b>	<b>4 servings</b>	

1. Cut potatoes in thin slices (about 3 cups). Mix flour, salt and pepper.
2. In greased 1 1/2 quart metal or heatproof glass bowl, arrange 3 layers of potatoes and ham, sprinkling each layer of potatoes with part of the flour mixture and dotting with butter.
3. Pour milk over potatoes and cover bowl with foil.
4. Pour 2 cups water in cooker. Use 3 cups for 6/8-qt. recipe. Place bowl on rack in cooker.
5. Cover, set control at 10 PSI and cook 20 minutes after control jiggles.
6. Cool cooker normally for 5 minutes, then place under faucet.
7. Garnish potatoes, if desired, with paprika, chopped parsley or grated Cheddar cheese.

## Pork Chops and Browned Rice.

4.2 Qt.	6/8 Qt.	Ingredients
4	8	Pork Chops - 1/2 in. thick
1 Tbsp	2 Tbsp	Fat
1 cup	2 cups	Rice, uncooked
1 1-lb can	2 1-lb cans	Tomatoes
1 tsp	2 tsp	Salt
1/4 tsp	1/2 tsp	Pepper
1/4 tsp	1/2 tsp	Chili Pepper
2 Tbsp	1/4 cup	Onions, chopped
3 Tbsp	6 Tbsp	Green Pepper, chopped
2 cups	4 cups	Water
<b>4 servings</b>	<b>8 servings</b>	

1. Brown chops in fat in cooker. Remove.
2. Place rice in hot fat. Stir constantly until browned.
3. Add tomatoes (with liquid) and remaining ingredients. Stir well, breaking up tomatoes. Add pork chops and water.
4. Cover, set control at 10 PSI and bring pressure up over moderate heat. Cook 12 minutes after control jiggles.
5. Cool cooker normally for 5 minutes, then place under faucet.



## Chow Mein

<b>4.2 Qt</b>	<b>6/8 Qt.</b>	<b>Ingredients</b>
3/4 lb.	1 1/2 lbs.	Pork, cubed
3/4 lb.	1 1/2 lbs.	Beef, cubed
2 Tbsp	3 Tbsp	Fat
2 cups	4 cups	Water
2	4	Onions, medium, sliced
3 cups	6 cups	Celery, sliced
1/2 tsp	1 tsp	Salt
Dash	1/4 tsp	Pepper
2 Tbsp	1/4 cup	Cornstarch
1/2 cup	1 cup	Water
1/4 cup	1/2 cup	Soy Sauce
1 1-lb. can	2 1-lb. cans	Bean Sprouts, drained
1/2 cup	1 cup	Mushrooms, sliced
1 8-oz. can	2 8-oz. cans	Water Chestnuts, drained and sliced
<b>4-6 servings</b>	<b>8-12 servings</b>	

1. Brown meat in fat in cooker.
2. Add water, onions, celery, salt and pepper.
3. Cover, set control at 10 PSI and cook 10 minutes after control jiggles.
4. Cool cooker normally for 5 minutes, then place under faucet.
5. Mix cornstarch and water. Gradually stir into meat mixture. Cook until thickened, stirring constantly.
6. Add remaining ingredients. Serve on hot rice.

## Rice

The best way to cook rice is in an uncovered mold or pan, set on a rack in cooker.

	<b>Rice</b>	<b>Water</b>	<b>Salt</b>	<b>Minutes to Cook after Control Jiggles</b>
<b>Long Grain Rice</b> (regular or converted)	1 cup	1 1/2 cups	1 tsp	15
<b>Long Grain Brown Rice</b> (regular)	1/2 cup	1 1/2 cups	1/2 tsp	35
<b>Wild Rice</b>	1/2 cup	1 1/4 cups	1/4 tsp	40

1. Place rice, water and salt in greased 1-quart mold.
2. Place on rack in cooker. Add 4 cups water.
3. Cover; set control at 10 PSI and cook.
4. Reduce pressure instantly and remove rice from mold.

# RECIPES -Fish and Seafood

## Fish with Sweet-Sour Sauce

4.2 Qt.	6/8 Qt.	Ingredients
1	2	Onions, sliced
3	6	Carrots, sliced
1	2	Bay Leaf
1	2	Parsley Sprigs
1 1/2 Cups	3 cups	Water
1 1/2 lbs.	3 lbs.	Fish (haddock, pike, trout)
1 tsp	2 tsp	Salt
Dash	1/4 tsp	Pepper
2 Tbsp	1/4 cup	Butter or Margarine
1 Tbsp	2 Tbsp	Flour
3 Tbsp	1/3 cup	Brown Sugar
1/3 cup	2/3 cup	Vinegar
1/4 tsp	1/2 tsp	Salt
<b>4 servings</b>	<b>8 servings</b>	

1. Place onions, carrots , bay leaf, parsley and water in cooker. Place fish on rack in cooker. Season with salt and pepper.
2. Cover, set control to 10 PSI and cook 2-4 minutes after control jiggles. Reduce pressure instantly
3. Place fish on hot platter. Force onions and carrots through a course sieve or puree in blender; add to strained broth.
4. Brown butter, stir in flour. Gradually stir in broth. Cook until thickened, stirring constantly. Stir in sugar, vinegar and salt.
5. Pour over fish. Garnish with chopped parsley.

## Perch or Halibut Steak

4.2 Qt.	6/8 Qt.	Ingredients
1 1/2 lbs.	3 lbs.	Perch or Halibut
2 Tbsp	4 Tbsp	Butter or Margarine
1 1/2 tsp	1 Tbsp	Salt
Dash	1/4 tsp	Pepper
2 Tbsp	4 Tbsp	Onion, chopped
1/4 cup	1/2 cup	Water for frozen fish
	or	or
1/2 cup	1 cup	Water for fresh fish
2 Tbsp	4 Tbsp	Flour
1/2 cup	1 cup	Water
1/4 tsp	1/2 tsp	Salt
<b>4 servings</b>	<b>8 servings</b>	

1. Cut fish into individual servings.
2. Brown fish in hot fat in bottom of cooker. Place fish on rack.
3. Season with salt and pepper. Sprinkle with onions. Add water
4. Cover, set control to 10 PSI and cook for 4 minutes after control jiggles.
5. Cool cooker normally. Remove fish and place on hot platter.
6. Thicken liquid with flour mixed with cold water. Stir until smooth. Add salt and parsley.

## Shrimp Curry

4.2 Qt.	6/8 Qt.	Ingredients
1 lbs.	2 lbs.	Shrimp
2 Tbsp	4 Tbsp	Fat
2 Tbsp	4 Tbsp	Flour
1 1/4 cups	2 1/2 cups	Hot Milk
1/4 tsp	1/2 tsp	Slat
Dash	1/4 tsp	Paprika
1 tsp	2 tsp	Onion, minced
1 tsp	2 tsp	Curry Powder
1 tsp	2 tsp	Lemon Juice
<b>4 servings</b>	<b>8 servings</b>	

1. Cook shrimp according to chart directions.
2. Melt fat in saucepan. Blend in flour.
3. Add hot milk slowly, stirring constantly.
4. Add remainder of ingredients and cook until smooth and thickened, stirring constantly.
5. Add shrimp and serve over cooked rice.

## Shrimp Creole

4.2 Qt.	6/8 Qt.	Ingredients
1/2 lbs.	1 lb	Cooked or Canned Shrimp
1/2 cup	1 cup	Onion, diced
1/2 cup	1 cup	Celery, diced
1	2	Clove Garlic, minced
1 Tbsp	2 Tbsp	Fat
1 1-lb. can	2 1-lb. cans	Tomatoes
1 8-oz. can	2 8-oz. cans	Tomato Sauce
1 1/2 tsp	1 Tbsp	Salt
1 tsp	2 tsp	Sugar
1/2 tsp	1 tsp	Chili Powder
1 Tbsp	2 Tbsp	Worcestershire Sauce
Dash	Dash	Red Pepper Sauce
1/2 cup	1 cup	Green Pepper, diced
1 Tbsp	2 Tbsp	Cornstarch
1/2 cup	1 cup	Water
<b>6 servings</b>	<b>12 servings</b>	

1. Cook shrimp according to Directions Table.
2. Cook onion, celery and garlic in fat in cooker until tender but not brown.
3. Add tomatoes (with liquid), tomato sauce, seasonings, green pepper and shrimp.
4. Cover, set control to 10 PSI and cook 3 minutes after control jiggles. Reduce pressure instantly.
5. Mix cornstarch and water. Gradually stir into Creole. Cook until thickened, stirring constantly. Serve over rice.

# RECIPES - Veal, Lamb, Poultry and Game.

## Irish Stew

4.2 Qt.	6/8 Qt.	Ingredients
1 1/2 lbs.	3 lbs.	Lamb Stew Meat - 1 in. pieces
2 Tbsp	3 Tbsp	Fat
3 cups	4 cups	Water
1 tsp	2 tsp	Salt
1/2 tsp	1 tsp	Paprika
1 tsp	2 tsp	Celery Seed
1/2 cup	1 cup	Onion, chopped
1 cup	2 cups	Turnips, sliced
1 cup	2 cups	Carrots, sliced
1 cup	2 cups	Potatoes, sliced
1 cup	2 cups	Parsnips, sliced
<b>4-6 servings</b>	<b>8-12 servings</b>	

1. Brown lamb in fat in cooker. Add water and seasonings.
2. Cover, set control at 10 PSI and cook 8 minutes after control jiggles.
3. Cool cooker normally for 5 minutes, then place under faucet. Add vegetables.
4. Cover, set control at 10 PSI and cook 5 minutes after control jiggles. Reduce pressure instantly.
5. Prepare gravy recipe.

## Veal Scallopini

4.2 Qt.	6/8 Qt.	Ingredients
1 1/4 lbs	2 1/2 lbs	Veal Steak - 1/2 in. thick
3 Tbsp	6 Tbsp	Flour
1 tsp	2 tsp	Salt
Dash	1/4 tsp	Pepper
1/2 tsp	1 tsp	Paprika
3 Tbsp	5 Tbsp	Fat
1	2	Clove Garlic, minced
1	2	Onion, medium, sliced
1/2 tsp	1 tsp	Dry Mustard
3 cups	6 cups	Tomato Juice
1/2 cup	1 cup	Mushrooms, sliced
2 Tbsp	1/4 cup	Parsley, chopped
<b>4-5 servings</b>	<b>8-10 servings</b>	

1. Cut veal into serving pieces.
2. Mix flour, salt, pepper and paprika; coat veal.
3. Brown veal in hot fat in cooker. Add remaining ingredients except mushrooms and parsley.
4. Cover, set control to 10 PSI and cook 12-15 minutes after control jiggles.
5. Cool cooker normally for 5 minutes; then place under faucet.
6. Stir in mushrooms and parsley; heat through.

## Chicken Paprika

4.2 Qt.	6/8 Qt.	Ingredients
1	2	Chicken - 2 1/2 - 3 lbs.
1 tsp	2 tsp	Salt
Dash	1/4 tsp	Pepper
1 tsp	2 tsp	Paprika
3 Tbsp	6Tbsp	Flour
2 Tbsp	1/4 cup	Fat
3 cups	4 cups	Water
1	2	Chicken Bouillon Cube
1 cup	2 cup	Diary Sour Cream
<b>4-6 servings</b>	<b>8-12 servings</b>	

1. Cut chicken into individual servings.
2. Mix salt, pepper, paprika and flour, coat chicken.
3. Brown in hot fat in cooker. Place on rack.
4. Slowly add water and bouillon cube.
5. Cover, set control to 10 PSI and cook 12 minutes after control jiggles.
6. Cool cooker normally for 5 minutes, then place under faucet.
7. Stir in sour cream; heat thorough.

## Fried Chicken

4.2 Qt.	6/8 Qt.	Ingredients
1	2	Chicken - 2 1/2 - lbs.
1/4 cup	1/2 cup	Flour
1 1/2 tsp	1 Tbsp	Salt
Dash	1/4 tsp	Pepper
1 tsp	2 tsp	Paprika
2 Tbsp	1/4 cup	Fat
1	2	Onion, small, cut in halves
2 cups	2 1/2 cups	Water
<b>4-5 serving</b>	<b>8-12 servings</b>	

1. Cut chicken into individual servings. Mix flour, salt, pepper and paprika; coat chicken.
2. Brown in hot fat in cooker. Add onion and water. Place chicken on rack in cooker.
3. Cover, set control at 10 PSI and cook 12 minutes after control jiggles.
4. Cool cooker normally for 5 minutes, then place under faucet.
5. Place chicken under the oven broiler for a few minutes to crisp. Prepare gravy recipe.

### Hasenpfeffer (Sweet Sour Rabbit)

4.2 Qt.	6/8 Qt.	Ingredients
1	2	Rabbit, domestic (2 1/2 lbs.)
1 1/2 cups	3 cups	Vinegar
3 cups	6 cups	Water
3	6	Bay Leaves
1 1/2 tsp	3 tsp	Salt
1/2 tsp	1 tsp	Pepper
1	2	Onion, sliced
1/4 cup	1/2 cup	Flour
3 Tbsp	6 Tbsp	Fat
1 cup	2 cups	Dairy Sour Cream
5	10	Gingersnaps, crumbled
<b>3-4 servings</b>	<b>6-8 servings</b>	

1. Cut rabbit into individual servings. Place in shallow glass dish. Mix vinegar and water; pour over rabbit.
2. Add bay leaves, salt, pepper and onion. Cover and refrigerate, turning occasionally, at least 12 hours, but no longer than 24 hours.
3. Remove rabbit from marinade; dry on paper towels. Coat with flour and brown in hot fat in cooker.
4. Strain marinade and add 1 1/4 cups for 3-4 servings recipe. Add 2 cups for 6-8 serving recipe.
5. Cover, set control to 10 PSI and cook for 15-20 minutes after control jiggles.
6. Cool cooker normally for 5 minutes; then place under faucet.
7. Stir in sour cream and gingersnap crumbs; heat through.

### Venison Pot Roast

4.2 Qt.	6/8 Qt.	Ingredients
2 lbs.	4 lbs	Venison Pot Roast - 3-4 in. thick
2 Tbsp	4 Tbsp	Fat
1 tsp	2 tsp	Salt
Dash	1/4 tsp	Pepper
2 cups	2 1/2 cups	Water
1	2	Clove Garlic, minced
<b>4-6 servings</b>	<b>8-12 servings</b>	

1. Brown venison in fat in cooker. Pour off excess fat.
2. Season with salt and pepper. Add water and garlic.
3. Cover, set control to 10 PSI and cook for 30-40 minutes after control jiggles.
4. Cool cooker normally for 5 minutes, then place under faucet.
5. Prepare gravy recipe. Serve very hot.

# RECIPES - Vegetables and Soups

## Baked Beans

4.2 Qt.	6/8 Qt.	Ingredients
1 lb	2 lbs.	Dried Navy Beans
<b>or</b>		
(2 1/2 cups)	(4 2/3 cups)	(Great Northern Beans)
4 cups	8 cups	Water
3 slices	6 slices	Bacon or Salt Pork, cut in 2 in. pieces
2 Tbsp	1/4 cup	Onion, chopped
1/4 cup	1/2 cup	Molasses or Syrup
3 Tbsp	6 Tbsp	Brown Sugar
1 tsp	2 tsp	Dry Mustard
1 tsp	2 tsp	Salt
Dash	Dash	Pepper
<b>4 servings</b>	<b>8 servings</b>	

1. Heat beans and water to boiling in cooker; boil 2 minutes. Remove from heat; cover and let stand 1 hour.
2. Drain beans, reserving liquid. Add enough water to bean liquid to measure 4 cups. Use 8 cups for 6/8-qt. recipe.
3. Stir bacon and onion into beans. Mix bean liquid and remaining ingredients; pour over beans.
4. Cover, set control to 10 PSI and cook 25 minutes after control jiggles.
5. Cool cooker normally for 5 minutes, then place under faucet.

**Alternate Method:** Soak beans in 4 cups water overnight. Use 8 cups for 6/8-qt recipe. Drain, reserving liquid. Continue as directed in step 2.

## Spicy Red Cabbage

4.2 Qt.	6/8 Qt.	Ingredients
1/2 cup	1 cup	Raisins
2 Tbsp	1/4 cup	Bacon Fat, Butter or Margarine
5 cups	10 cups	Red Cabbage, shredded
1 cup	2 cups	Apples, sliced
3/4 cup	1 1/2 cups	Onions, chopped
1 tsp	1 1/2 tsp	Mixed Spices, tied in wet cheesecloth
1/2 cup	2/3 cup	Water
3/4 tsp	1 1/2 tsp	Salt
1/4 tsp	1/2 tsp	Pepper
2 Tbsp	1/4 cup	Sugar
<b>4 servings</b>	<b>8 servings</b>	

1. Place all ingredients in cooker.
2. Cover, set control at 10 PSI and cook 5 minutes after control jiggles. Reduce pressure instantly.
3. Remove spices.

## Hubbard Squash

4.2 Qt.	6/8 Qt.	Ingredients
2 cups	4 cups	Squash, cooked
1/2 tsp	1 tsp	Salt
Dash	Dash	Pepper
2 Tbsp	1/4 cup	Bacon drippings
2 Tbsp	1/4 cup	Brown Sugar
2 Tbsp	1/4 cup	Orange Juice
<b>4 servings</b>	<b>8 servings</b>	

1. Cook squash according to chart directions.
2. Scrape squash from shell and mash it.
3. Add other ingredients and heat squash thoroughly.

## Two-Minute Vegetable Plate

4.2 Qt.	6/8 Qt.	Ingredients
1 1/2 cups	1 cup	Water
1 small	1 large	Cauliflower, broken into large flowerets
1/2 lb	1 lb	Green Beans, cut in halves
4	8	Carrots, medium, quartered and cut lengthwise
1 small	1 large	Bunch Broccoli, stems cut in quarters
1 tsp	1 1/2 tsp	Salt
3 Tbsp	6 Tbsp	Browned Butter
<b>4 servings</b>	<b>8 servings</b>	

1. Put water in cooker with rack.
2. Place vegetables on rack. Season with salt.
3. Cover, set control at 10 PSI and cook 2-3 minutes after control jiggles. Reduce pressure instantly.
4. Arrange vegetables on large serving plate. Serve with hot browned butter.

## Vegetable Soup

4.2 Qt.	6/8 Qt.	Ingredients
1 1/2 lbs	3 lbs	Soup Meat and Bones
1 small	1 medium	Onion, sliced
1 tsp	2 tsp	Salt
Dash	1/4 tsp	Pepper
1 1/2 qt.	2 1/2 qt.	Water
1/2 cup	1 cup	Carrots, sliced
1 cup	2 cups	Canned Tomatoes
1 cup	2 cups	Green Beans, cut up
1/2 cup	1 cup	Celery, diced
<b>4 servings</b>	<b>8 servings</b>	

1. Place soup meat and bone, onion, salt, pepper and water in cooker.
2. Cover, set control at 10 PSI and cook 50 minutes after control jiggles.
3. Cool cooker normally for 5 minutes, then place under faucet.
4. Remove bone and meat. Strain broth. Return broth and meat only to cooker.
5. Add vegetables
6. Cover, set control at 10 PSI and cook 5 minutes after control jiggles.
7. Cool cooker normally for 5 minutes, then place under faucet. Sprinkle with chopped parsley.



## Chicken Gumbo

4.2 Qt.	6/8 Qt.	Ingredients
2 1/2 lbs	3 1/2 lbs	Chicken
1/4 cup	1/4 cup	Flour
1/2 tsp	1/2 tsp	Salt
1/4 tsp	1/4 tsp	Pepper
2 Tbsp	4 Tbsp	Fat
1/4 cup	1/2 cup	Onion, chopped
1 Tbsp	2 Tbsp	Parsley, chopped
1 1/2 Tbsp	3 Tbsp	Pimento, chopped
1 1/4 cups	2 1/2 cups	Tomatoes
3 cups	5 cups	Water
1 tsp	2 tsp	Salt
1 cup	2 cups	Okra
3/4 cup	1 1/2 cups	Rice, cooked
<b>4 servings</b>	<b>8 servings</b>	

1. Cut chicken into pieces for serving and dredge in flour, salt and pepper.
2. Brown well in cooker with onion in hot fat.
3. Add parsley, pimento, tomatoes, water and salt.
4. Cover, set control on at 10 PSI and cook for 25 minutes after control jiggles. Cool cooker normally for 5 minutes and then place under faucet.
5. Add okra and cooked rice and simmer 5 minutes.

## Clam Chowder

4.2 Qt.	6/8 Qt.	Ingredients
1/4 lb	1/2 lb	Salt Pork, diced
1/2 cup	1 cup	Onion, sliced
1 tsp	2 tsp	Salt
Dash	1/4 tsp	Pepper
2 1/2 cups	4 cups	Water
1 1-lb. can	2 1-lb. can	Tomatoes
1 cup	2 cups	Potatoes, diced
1 6 1/2-oz. can	2 6 1/2-oz. cans	Clams
<b>4-6 servings</b>	<b>8-12 servings</b>	

1. Cook and stir salt pork in cooker until pork is crisp. Pour off excess fat.
2. Add onion, salt, pepper, water, tomatoes (with liquid) and potatoes. Break up tomatoes.
3. Cover, set control at 10 PSI and cook 6 minutes after control jiggles.
4. Cool cooker normally for 5 minutes, then place under faucet.
5. Add clams (with liquid). Bring to a boil and cook uncovered for 2 minutes. Sprinkle with thyme.

# CANNING

**CAUTION: Pressure can only in models with selective control (5, 10, 15 lbs.) only. Do not try to can in single-control model.**

**WARNING: Read instructions for ordinary pressure cooking before you attempt to use your cooker or canner for canning.**

## General Tips for Pressure Canning

The U.S. Department of agriculture recommends pressure canning as the only safe way to can meats, fish, poultry, and all common vegetables. Fruits and plain tomato products may be canned by the hot-water-bath method, but pressure canning them will save time and energy.

Use a water bath canner for pickles, jams and jellies. Do not blanch in a pressure canner. Use a blancher or covered pot with a suitable basket.

To can mixtures of foods (soups, stews, etc) use the time required for the ingredient with the longest processing time. Sometimes it is better to can ingredients separately (meat and vegetables, for example) and then combine them to heat for serving.

Before canning for the first time, follow this procedure to get familiar with how your canner operates:

1. Pour 2 quarts of water and 1 tablespoon of vinegar in canner.
2. Close cover and place control on vent tube at 10lbs. pressure
3. Heat on high until control jiggles
4. Turn down heat so that control rocks gently. Note the heat setting on your range that maintains this level
5. Remove from heat and let the caner cool until pressure is fully down.

Note: At altitudes above 1,000 feet, increase pressure by 5 lbs.

## How to Pressure Can in Glass Jars

**CAUTION: Use only standard jars intended for home canning. These jars will have manufacturer's name molded in the glass. Never use jars from commercial food products.**

1. Check jars and lids for nicks, chips, cracks, or sharp edges. Discard any imperfect jars and lids.

**CAUTION: Use only NEW metal lids (used with metal screw bands).**

2. Wash jars and lids thoroughly in hot soapy water. Rinse.
3. Keep jars covered with hot water until filled. You need not sterilize jars for pressure canning. Place metal lids in hot or boiling water as directed by manufacturer.
4. Select fresh, firm (not overripe) product. Sort according to size and ripeness.
5. Wash and prepare food according to chart directions (see canning pages).
6. Pack food into jars.  
Most foods may be packed raw. Pack raw foods tightly because raw foods shrink during processing. Food may also be pre-heated or partially cooked before packing. Pack hot food fairly loosely.
7. Finish filling jar with syrup, water or juice, allowing adequate head space according to chart (see canning pages). Add salt (if desired) according to chart.
8. Insert blade of plastic spatula down sides of jar to release any trapped air bubbles.

9. Wipe rim of jars clean and close lids according to manufactures directions.
10. Place rack in canner and add recommended amount of hot water for hot pack. For cold pack use room temperature water.  
Add 1 tablespoon vinegar or 1 teaspoon cream of tartar to help prevent water stains in canner.
11. Set jars on rack in canner. it is all right if sides of jars touch each other.

Note: 22-quart canner is furnished with two flat racks for stacking half-pint or pint jars. Place one rack in bottom of canner and the other between tiers of jars.



12. Close canner. Make sure that canner is properly closed, with grips on lid directly over grips on pan.
13. With pressure control OFF, heat on high until steam comes out of vent tube. Let steam vent for 10 minutes.
14. After venting, place control on vent tube using a hot pad at correct pressure according to the chart.
15. When control jiggles vigorously, reduce heat so that control rocks or jiggles gently.  
**CAUTION: Prevent drafts from blowing over canner and avoid turning heat up and down. This can cause uneven pressure and can cause liquid to be forced out of jars.**
16. Process according to time given in charts. Count processing time from the time the control starts to jiggle vigorously.
17. When processing time is completed, turn off heat. Let canner cool.

**CAUTION: Do not fast-cool by setting canner in water or by running water over the canner. Never lift control to release pressure.**

**It takes about 35-40 minutes for pressure to drop in a smaller cooker filled with jars, and 45 minutes to an hour in a large canner with a full load.**

18. When pressure is fully down, remove control. Carefully remove cover.

**WARNING: Escaping steam can scald you and the pressure control may be hot. Protect your hands with pot holders or oven mitts and tilt cover so steam escapes away from you.**

To test if pressure is down, gently nudge control. If you see steam spurting out, pressure is not yet down. Let canner continue to cool.

Note: You may hear a hissing noise when control is nudged. If you also see steam spurt out, pressure is not down. If you do not see steam, the hissing is air entering the canner.

19. Using a jar lifter, remove jars from canner. Set jars on a cooking rack or on several thickness of cloth.

**CAUTION: Never set hot jars on a cold or wet surface. The jars may break.**

20. Complete seal if jars are not self sealing. If any liquid boiled out during processing, seal jar as is. Do not add liquid, as that would require reprocessing. Fruits and vegetables not covered by liquid may turn dark, but they will not spoil.
21. Let jars cool. Keep jars out of drafts, and upright.
22. After 12 hours. Remove screw bands from jars with metal lids. If a screw band does not easily come off, cover it for one minute with a hot damp cloth. This will expand the metal slightly and usually permit the band to be removed. If the band cannot easily be removed, leave it on.

**CAUTION: Never force screw bands off. You might break the seal.**

23. Examine jars for leaks and test seal. For a metal lid, test the seal by tapping with a teaspoon. A clear ring is a sign of a good seal. If a lid is curved down and does not move when tapped, that is also a sign of a good seal.

**WARNING: If a jar leaks or is not sealed, use the contents promptly or reprocess within 24 hours with new lids for the full recommended processing time.**

24. Wipe jars with a damp cloth, dry and label with contents and date. Store in a cool dry place.

CAUTION: Do not permit contents to freeze. The liquid will expand and may break the jar.

## Pressure Canning Charts

Canner size	Amount of Water In Canner	Jar Capacity of Canner			
		Half Pint	Pint, Reg.	Pint, Wide Mouth	Quarts
8 Qt.	2 Qt.	8	6	5	-
12 Qt.	2 1/2 Qt.	13	10	8	7
22 Qt.	2 1/2 Qt.	36*	20*	16*	7

Add extra pint of water to canner if processing less than full capacity.

\*If jars are stacked and an additional rack is used between stacks.

### Amount of Salt for Canning Vegetables and Meats

Jar Size	Salt
Half Pint (8 oz.)	1/4 tsp
Pint (16 oz.)	1/2 tsp
Quart (32 oz)	1 tsp

\*Vegetables and meats can be canned successfully with or without salt

### HOW TO CLOSE JARS: FOLLOW LID MANUFACTURER'S DIRECTIONS CAREFULLY.

Use a flat metal lid with sealing compound and a metal screw band, which fits any standard mason jar.

1. Fill jar. Wipe rim clean.
2. Place lid in hot or boiling water, according to manufacturer's directions.
3. Put new lid on jar with sealing compound next to glass.
4. Screw metal band on tight by hand. Do not use a wrench. Over tightening will cause lids to buckle.
5. This jar is self sealing. Do not tighten after jar is removed from canner.

#### How To Close Jars

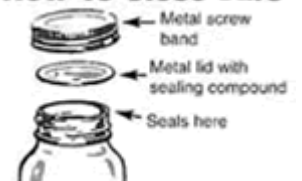

### CAUTION: DETECTING SPOILAGE

A leaking jar or a bulging lid may be a sign of spoilage. Look for "off" odor or color. Never taste food you think has spoiled. Throw it away. Also it is possible for food to contain botulism without showing any signs of spoilage, so boil non-acid vegetables and meats for ten minutes before tasting and reboil leftovers food before serving.

# Pressure Canning Meat and Fish

All meat and fish should be thoroughly cooled and cleaned before canning. REDUCE PRESSURE NORMALLY.

FOOD	Minutes To Cook After Control Jiggles		Pounds Pressure
	Pint Jars	Quart Jars	
<b>Beef, Veal, Lamb, Pork</b> Precook meat until medium done or until pieces when cut show almost no pink at center. Cut in pieces. Add salt. Pack. Fill with liquid within 1 in. from top. Adjust lids. Process.	75	90	10
<b>Pork Chops, Ham</b> Fry meat until brown. Add salt. Pack. Fill with liquid to within 1 inch from top. Adjust lids. Process	75	90	10
<b>Chicken (with bones)</b> Precook disjointed chicken with liquid until medium done. Add salt. Pack. Fill with liquid to within 1 inch from top. Adjust lids. Process	65	75	10
<b>Chicken (without bones)</b> Precook disjointed chicken with liquid until medium done. Remove bones. Add salt. Pack. Fill with liquid to within 1 inch from top. Adjust lids. Process	75	90	10
<b>Chicken (fried)</b> Fry disjointed chicken in hot fat until it is lightly browned. Add salt. Pack. Fill with liquid to within 1 in. from top. Adjust lids. Process.	65	75	10
<b>Rabbit, Duck, Turkey</b> - Follow directions for Chicken.			
<b>Soup Stock</b> Cook soup stock. Skim fat and remove bones. Pour hot into containers, to within 1/2 inch from top. Adjust lids. Process.	20	25	10
<b>Fish (except Salmon)</b> Cut fish in pieces. Precook. Remove bones and skin if desired. Add salt. Pack to within 1 in. from top. Add 2 Tbsp salad oil to tuna. Adjust lids. process.	110		10
<b>Salmon</b> Slowly pour hot water on fish, being careful not to break the skin. Scrape gently until skin is white and clean. Wipe dry. Cut, leaving backbone in. Add salt. Pack to within 1 in. from top. Adjust lids. Process.	110		10

**At altitudes of 1,000 feet or higher, use 15 lbs. instead of 10 lbs. pressure.**

# Pressure Canning Vegetables

FOOD	Minutes to Cook After Control Jiggles		Pounds Pressure
	Half Pint & Pint Jars	Quart Jars	
<b>Asparagus</b> Wash. Grade. Trim off scale. Cover with boiling water. Cook 2 minutes. Pack hot, cover with liquid. Or pack raw and cover with boiling water. Leave 1/2 in. head space. Add salt. Adjust lids. Process.	30	40	10
<b>Beans, Lima (fresh)</b> Shell. Grade. Bring to a boil. Pack hot and cover with water. Or pack raw and cover with boiling water. Leave 1 in. head space in pints. Leave 1 1/2 inches in quarts. Add salt. Adjust lids. Process.	40	50	10
<b>Beans, String or Wax</b> Wash. String. Cut in pieces. Boil 5 minutes. Pack hot. Cover with boiling liquid. Pr pack raw and cover with boiling water. Leave 1/2 in. head space. Add salt. Adjust lids. Process.	20	25	10
<b>Beets</b> Wash. Retain 1 in. of the stem. Cook in canner with 1-1 1/2 cups water at 15 lbs. for 6 minutes. Cool canner under faucet. Open canner. Cover beets with cold water. Slip off skins. Cut into 1/2 in. slices. Pack in jars. Cover with fresh boiling water leaving 1 inch head space. Add salt. Adjust lids. Process.	30	30	10
<b>Carrots</b> Scrape. Slice or cut as desired. Boil for 5 minutes. Pack. Cover with hot liquid, leaving 1 inch head space. Add salt. Adjust lids. Process.	25	30	10
<b>Corn (whole kernel)</b> Remove husks. Cut kernels from cob. To each quart of corn, add 1 pint of boiling water and 1 tsp of salt. Boil 1 minute. Pack loosely and cover with water. Or pack raw loosely and cover with boiling water. Leave 1 in. head space. Add salt, Adjust lids. Process.	55	85	10
<b>Greens</b> Can only very fresh tender greens. Wash carefully. Remove tough stems. Boil in small amount of water. Pack loosely. Cover with hot liquid. Leave 1 in. head space. Add salt. Adjust lids. Process.	70	90	10
<b>Mushrooms</b> Trim and soak in cold water 10 minutes. Wash. Cut large ones in half. Cook gently 15 minutes. Pack hot and cover with boiling water. Leave 1/2 in. head space. Add salt. Adjust lids. Process.	45	-	10
<b>Okra</b> Wash and trim. Cook 1 minute. Cut into 1 in. lengths. Pack hot and cover with boiling water. Leave 1 in. head space. Add salt. Adjust lids. Process.	25	40	10

**Peas (fresh Blackeye, Cowpeas, Blackeye Beans)**

Shell and wash. Bring to boil. Drain. Pack loosely and cover with boiling water. Or pack raw loosely and cover with boiling water. Leave 1 1/2 in. head space. Add salt. Adjust lids. Process. 45 40 10

**Peas (green)**

Shell. Use only young, fresh peas. Bring to a boil. Pack loosely and cover with boiling water. Or pack raw loosely and cover with boiling water. Leave 1 in. Head space. Add salt. Adjust lids. Process. 40 40 10

**Potatoes**

Wash, pare and cut into 1/2 in. cubes. or use whole 2 1/2 inch in diameter. Boil cubes 2 minutes; whole potatoes 10 minutes. Drain. Pack and cover with boiling water. Leave 1 in. head space. Add salt. Adjust lids. Process. 35 40 10

**Pumpkin or Hubbard Squash**

Peel and cut into 1 inch cubes. Cook until tender. Pack hot. Leave 1 inch head space. Adjust lids. Process. 65 80 10

**Sauerkraut**

Heat well-fermented sauerkraut to simmering. Pack hot and cover with hot juice. leave 1 inch head space. Adjust lids. Process. 10 15 5

**Summer Squash (Zucchini)**

Wash Squash. Do not pare. Cut into small pieces. Boil 2-3 minutes. Pack hot ad cover with boiling liquid. leave 1 inch head space. Add salt. Adjust lids. Process. 30 40 10

**Sweet Potatoes**

Wash. Boil until skins slip off easily. Cut in pieces. For wet pack, pack and cover with boiling water. Leave 1 inch head space. Add salt. For dry pack, Pack cooked pieces and add no salt or liquid. Leave 1 inch head space. Adjust lids. Process. 65(wet) 90(wet) 10  
65(dry) 95 (dry) 10

**Tomatoes**

See [fruit chart](#)

Reduce pressure normally.

**At altitudes of 1,000 feet or higher use 15 lbs. instead of 10 lbs. pressure.**

# Pressure Canning Fruits

Fruits may be processed either in a boiling water bath or in a pressure canner. When using pressure method, **time processing very carefully** because fruits are easily overcooked. To keep peeled fruit from darkening before it is packed, place it in water to which ascorbic or citric acid has been added. These products may be obtained at drug or grocery stores. Follow package directions, or drop fruit in a solution of 1 gal. water, 2 tbsp salt and 2 tbsp vinegar. **REDUCE PRESSURE NORMALLY.**

FOOD	Minutes to Cook After Control Jiggles		Pounds Pressure
	Half Pint & Pint Jars	Quart Jars	
<b>Apples</b> Wash, pare and core and cut in pieces. Pack. Fill with syrup to within 1/2 inch from top. Or precook 3 minutes in syrup. Pack and add syrup. Adjust lids and process.	8	8	5
<b>Applesauce</b> Cook applesauce (NOT IN PRESSURE COOKER) pack within 1/4 in. from top. Adjust lids. Process.	8	10	5
<b>Apricots and Nectarines</b> Wash. Pack whole or halve and pit. Fill with syrup to within 1/2 inch from top. Adjust lids. Process	10	10	5
<b>Berries (except Strawberries)</b> Wash. Stem. Pack. Fill with syrup to within 1/2 inch from top. Adjust lids. Process.	8	8	5
<b>Cherries</b> Wash and stem. Pit. Pack. Fill with syrup to within 1/2 inch from top. Adjust lids. Process.	10	10	5
<b>Figs</b> Wash. Leave stems on. Boil for 2 minutes. Prepare a thin syrup with this water and boil figs in it for 5 minutes. Pack. Add 1 2/2 tsp lemon juice per pint or 1 Tbsp per quart. Fill with syrup to within 1/2 inch from top. Adjust lids. Process.	10	10	5
<b>Grapes</b> Wash and stem. Fill with syrup to within 1 1/2 inches from top. Adjust lids. Process.	8	8	5
<b>Peaches</b> Wash dip peaches in boiling water, then cold water. Remove skins. Cut in halves and remove pits. Pack. Fill with syrup to within 1/2 inch from top. Adjust lids. Process.	10	10	5
<b>Pears</b> Wash. Peel. Halve and core. Fill with syrup to within 1/2 inch from top. Adjust lids. Process.	10	10	5
<b>Pineapple</b> Slice and peel. Remove eyes and core. Boil 5-10 minutes in medium syrup. Pack. Fill with syrup to within 1/2 inch from top. Adjust lids. Process.	15	15	5
<b>Plums</b> Wash. prick skins. Fill with syrup within 1/2 inch from top. Adjust lids.	10	10	5



Process.

### Rhubarb

Wash. Cut in pieces. Pack. Add syrup to within 1/2 inch from top. Or cook rhubarb sauce (NOT IN PRESSURE COOKER) and pack. Adjust lids and process. 5 5 5

### Strawberries

Wash and stem. Boil gently 3 minutes with 1/2 cup sugar for each quart of fruit. Let stand overnight. Bring quickly to boil. Pack to within 1/2 inch from top. Adjust lids. Process in boiling water bath, not under pressure - 15 minutes for pints and quarts. 15 15

### Tomatoes

Scald 1/2 minute. Place in cold water. Remove skins. Quarter. Add salt. Pack Tightly. Or bring peeled and quartered tomatoes to a boil and then pack to within 1/2 inch of top. Adjust lids. Process. 25 25 10

### Tomato Juice

Cook tomatoes and put through food press. Season and bring to boil. Fill jars to within 1/4 inch from top. Adjust lids. Process. 20 20 5

Reduce pressure normally.

**At altitudes of 1,000 feet or higher use 15 lbs. instead of 10 lbs. pressure.**

**NOTE: It is recommended that home canned tomato products have acid added as part of the preservation process. The most common acid to add is bottled lemon juice, not fresh. Add one tablespoon per pint or two tablespoons per quart. This should be added to the jar before adding the tomatoes.**

## How To Make Syrup

Adding syrup to canned fruit helps to retain its flavor, color and shape. It does not prevent spoilage of these foods. The following guidelines for preparing and using syrups offer a new "very light" syrup, which approximates the natural sugar content of many fruits. The sugar content in each of the five syrups is increased by about 10 percent. Quantities of water and sugar to make enough syrup for a canner load of pints or quarts are provided for each syrup type.

### Preparing and using syrups.

Measures of Water and Sugar For 8 Half- Pint, 7 Pint or 4 Quart Load				
Syrup Type	Approx. % Sugar	Cups Water	Cups Sugar	Fruits commonly packed in syrup*
<b>Very Light</b>	10	6 1/2	3/4	Approximates natural sugar level in most fruits and adds the fewest calories
<b>Light</b>	20	5 3/4	1 1/2	Very sweet fruit. Try a small amount the first time to see if your family likes it.
<b>Medium</b>	30	5 1/4	2 1/4	Sweet apples, sweet cherries, berries, grapes.
<b>Heavy</b>	40	5	3 1/4	Tart apples, apricots, sour cherries, gooseberries, nectarines, peaches, pears, plums
<b>Very Heavy</b>	50	4 1/2	4 1/4	Very sour fruit. Try a small amount the first time to see if your family likes it.

\*many fruits that are typically packed in heavy syrup are excellent and tasteful products when packed in lighter syrups. It is recommended that lighter syrups be tried since they contain fewer calories from added sugar.

**Procedure:** Heat water and sugar together. Bring to a boil and pour over raw fruits in jars. For hot packs, bring water and sugar to boil, add fruit, reheat to boil, and fill jars immediately.

**Other sweeteners:** Light corn syrups or mild flavored honey may be used to replace up to half the table sugar called for in syrups.

## CANNING PROBLEMS

**Problem: Liquid is lost from jars.**

**Causes and Remedies:**

1. **Jars are packed too full or too tight.**  
When food and liquid are boiled, they expand. If there is not sufficient room, liquid will be forced out.  
Leave adequate head space of 1/2"- 1" as recommended in the chart.
2. **Air bubbles are trapped in jar.**  
When food begins to boil, air bubbles will force liquid out of the jar.  
Before closing jar; run a plastic spatula down the sides of the jar to release any trapped air.
3. **Pressure is allowed to fluctuate during processing.**  
If heat is adjusted up and down frequently, it may cause sudden changes in pressure, which may force liquid out of jars.  
After control starts to jiggle, adjust heat so that the control gently rocks. Avoid frequent adjustments.
4. **Pressure is reduced too rapidly after processing.**  
If pressure is rapidly reduced, such as by running cold water over the canner, or nudging the control frequently, the pressure in the canner may drop more quickly than the pressure in the jars, and liquid may be forced out of the jars.  
Allow canner to cool normally to room temperature. After 25-35minutes (for a small cooker) or 40-45 minutes (for a large canner), check pressure by nudging control.

**Problem: Canning jars break.**

**Causes and Remedies:**

1. **Commercial food product jars rather than home canning jars are used.**  
Use only canning jars intended for home canning.
2. **Damaged jars are used.**  
Old jars may have invisible cracks. Jars may be damaged in shipping. Carefully inspect jars before using.
3. **Jars are placed directly in canner without rack.**  
Always use rack.
4. **Hot jars are set on a cold or wet surface or exposed to cold drafts.**  
Set jars on a cooling rack or on several thickness of cloth. Protect from drafts.
5. **Jars are damaged by using a knife to release air bubbles.**  
Use only a plastic or rubber spatula to release trapped air.
6. Hot jars placed in cold water. Cold jars placed in hot water.

**FOR MORE INFORMATION ABOUT CANNING:**

1. Your University Extension County home economist will also have information about home canning.