

This Owner's Manual is provided and hosted by [Appliance Factory Parts](#).



Jade Dynasty RJGR3661C Owner's Manual

[Shop genuine replacement parts for Jade Dynasty
RJGR3661C](#)



[Find Your Jade Dynasty Gas Range Parts - Select From 23 Models](#)

----- Manual continues below -----



Service

This manual is to be used by qualified appliance technicians only. Maytag does not assume any responsibility for property damage or personal injury for improper service procedures done by an unqualified person.

Freestanding Gas Ranges

This Base Manual covers general information
Refer to individual Technical Sheet
for information on specific models

This manual includes, but is
not limited to the following:

**DGRSC and
RJGR
Models**

MAYTAG®

16023219
December 2004

Important Information

Important Notices for Servicers and Consumers

Maytag will not be responsible for personal injury or property damage from improper service procedures. Pride and workmanship go into every product to provide our customers with quality products. It is possible, however, that during its lifetime a product may require service. Products should be serviced only by a qualified service technician who is familiar with the safety procedures required in the repair and who is equipped with the proper tools, parts, testing instruments and the appropriate service information. **IT IS THE TECHNICIANS RESPONSIBILITY TO REVIEW ALL APPROPRIATE SERVICE INFORMATION BEFORE BEGINNING REPAIRS.**



WARNING

To avoid risk of severe personal injury or death, disconnect power before working/servicing on appliance to avoid electrical shock.

To locate an authorized servicer, please call (866) 820-9401 or contact the dealer from whom you purchased this product. For further assistance, please contact:

Customer Service Support Center

CAIR Center

Web Site	Telephone Number
WWW.MAYTAG.COM	1-866-820-9401
CAIR Center in Canada	1-800-688-2002
Amana Canada Product	1-866-587-2002

Recognize Safety Symbols, Words, and Labels



DANGER

DANGER—Immediate hazards which **WILL** result in severe personal injury or death.



WARNING

WARNING—Hazards or unsafe practices which **COULD** result in severe personal injury or death.



CAUTION

CAUTION—Hazards or unsafe practices which **COULD** result in minor personal injury, product or property damage.

Table of Contents

Important Information	2	Disassembly Procedures	
Safety Information		Removing and Replacing Unit.....	15
Safety Practices for Servicer	5	Knob Bezel(s)	15
Servicing	5	Control Panel, Rocker Switch(es), and	
Receiving Oven	5	Indicator Light(s)	15
ALL APPLIANCES	5	Surface Burner Micro Switch(es)	15
OVEN	5	Surface Burner Valve(s)	15
Delayed Ignition	6	Oven and Surface Broiler Infinite Switch	15
In Case of Fire	6	Spark Module	16
Using the Oven	6	Module(s) Removal	16
Connecting Range to Gas	7	Oven Light Socket	16
Electrical Requirements	7	Convection Fan	16
Extension Cord	7	Bake Burner and Ignitor	16
Grounding	7	Broil Burner and Ignitor	17
Product Safety Devices	8	Bake Gas Valve(s)	17
General Information		Broiler Gas Valve(s)	17
General Information	9	Backguard	17
Ordering Replacement Parts	9	Top Side Panel	17
Model Nomenclature	9	Side Panel	17
Model Identification	10	Door Removal	18
Service	10	Door Disassembly	18
Parts and Accessories	10	Gas Regulator	18
Functional Operation		Manifold Pipe	18
Bake or Broil Ignitors	10	Front Facade	19
Gas Valve	10	Module Type	19
Surface Burners, Griddle, Charbroil	10		
Spark System	10		
Troubleshooting Procedures	11 - 12		
Component Testing Procedures	13 - 14		

Safety Information

As with all appliances, there are certain rules to follow for safe operation. Verify everyone who operates the oven is familiar with the operations and with these precautions.

Use appliance only for its intended purpose as described. Pay close attention to the safety sections of this manual.

Recognize the safety section by looking for the symbol or the word safety.

Recognize this symbol as a safety precaution.



WARNING

If the information in this manual is not followed exactly, a fire or explosion may result causing property damage, personal injury or death.

Do not store or use gasoline or other flammable vapors or liquids in the vicinity of this or any other appliance.

WHAT TO DO IF YOU SMELL GAS

- Extinguish any open flame.
- Do not try to light any appliance.
- Do not touch any electrical switch; do not use any phone in your building.
- Immediately call your gas supplier from a neighbor's phone. Follow the gas supplier's instructions.
- If you cannot reach your gas supplier, call the fire department.

Installation and service must be performed by an authorized installer, service agency or gas supplier.



WARNING

To avoid risk of electrical shock, property damage, personal injury or death; verify wiring is correct, if components were replaced. Verify proper and complete operation of unit after servicing.



WARNING

This gas appliance contains or produces a chemical or chemicals which are known to the state of California to cause cancer, birth defects or other reproductive harm. To reduce the risk from substances in the fuel or from fuel combustion make sure this appliance is installed, operated, and maintained according to the instructions in this manual.

Due to the nature of cooking, fires can occur as a result of overcooking or excessive grease. Although a fire is unlikely, if one occurs proceed as follows:

Oven Fires

1. Do not open the oven door.
2. Turn all controls to the OFF position.
3. As an added precaution turn off the electricity at the main circuit breaker or fuse box and the gas at the main supply valve.
4. Allow the food or grease to burn itself out in the oven.

If smoke or fire persist call the local fire department.

To avoid risk of property damage or personal injury do not obstruct the flow of combustion or ventilation air to the oven.

To avoid risk of electrical shock, serious personal injury or death: Verify the oven has been properly grounded and always disconnect the electrical supply before servicing this unit.

NOTE: The maximum gas supply pressure for these models must not exceed 14 inches W.C.P.

Safety Information

Safety Practices for Servicer

Safe and satisfactory operation of gas ranges depends upon its design and proper installation. However, there is one more area of safety to be considered:

Servicing

Listed below are some general precautions and safety practices which should be followed in order to protect the service technician and consumer during service and after service has been completed.

1. **Gas smell**—Extinguish any and all open flames and open windows.
2. **Turn gas off**—Service range with gas turned off unless testing requires it.
3. **Checking for gas leaks**—Never check for leaks with any kind of open flame. Soap and water solution should be used for this purpose. Apply solution to suspected area and watch for air bubbles which indicates a leak. Correct leaks by tightening fittings, screws, connections, applying approved compound, or installing new parts.
4. **Using lights**—Use a hand flashlight when servicing ranges or checking for gas leaks. Electric switches should not be operated where leaks are suspected. This will avoid creating arcing or sparks which could ignite the gas. If electric lights are already turned on, they should not be turned off.
5. **Do not smoke**—Never smoke while servicing gas ranges, especially when working on piping that contains or has contained gas.
6. **Check range when service is completed**—After servicing, make visual checks on electrical connection, and check for gas leaks. Inform consumer of the condition of range before leaving.
7. **Adhere to all local regulations and codes when performing service.**

Receiving Oven

- Installer needs to show consumer location of the range gas shut-off valve and how to shut it off.
- Authorized servicer must install the range, in accordance with the Installation Instructions. Adjustments and service should be performed only by authorized servicer.
- Plug range into a 120-volt grounded outlet only. Do not remove round grounding prong from the plug. If in doubt about grounding of the home electrical system, it is consumers responsibility and obligation to have an ungrounded outlet replaced with a properly grounded three-prong outlet in accordance with the National Electrical Code. Do not use an extension cord with this appliance.
- Insure all packing materials are removed from the range before operating it, to prevent fire or smoke damage should the packing material ignite.

- Ensure range is correctly adjusted by a qualified service technician or installer for the type of gas (Natural or LP). Some ranges can be converted for use with Natural or LP gas.
- With prolonged use of a range, high floor temperatures could result. Many floor coverings will not be able to withstand this kind of use. Never install range over vinyl tile or linoleum that cannot withstand high temperatures. Never install range directly over carpeting.

ALL APPLIANCES

1. **Proper Installation**—Be sure your appliance is properly installed and grounded by a qualified technician.
2. **Never Use Appliance for Warming or Heating the Room.**
3. **Do Not Leave Children Alone**—Children should not be alone or unattended in the area where the appliance is in use. They should never be allowed to sit or stand on any part of the appliance.
4. **Wear Proper Apparel**—Loose fitting or hanging garments should never be worn while using appliance.
5. **User Servicing**—Do not repair or replace any part of the appliance unless specifically recommended in the manual. All other servicing should be referred to a qualified technician.
6. **Storage in or on Appliance**—Flammable materials should not be stored in oven.
7. **Do Not Use Water on Grease Fires**—Smother fire or flame, or use dry chemical or foam-type extinguisher.
8. **Use Only Dry Potholders**—Moist or damp potholders on hot surfaces may result in burns from steam. Do not let potholder touch burners. Do not use a towel or other bulky cloth.

OVEN

1. **Use Care When Opening Door**—Let hot air or steam escape before removing or replacing food.
2. **Do Not Heat Unopened Food Containers**—Build-up of pressure may cause container to burst and result in injury.
3. **Keep Oven Vents Ducts Unobstructed.**
4. **Placement of Oven Racks**—Always place oven racks in desired location while oven is cool. If rack is removed while oven is hot, do not let potholder contact hot heating element in oven.

Safety Information

Delayed Ignition

Bake Burner Flame

Allow no more than 40–60 seconds before burner ignites and heat is felt. To check for heat, open oven door to first stop and place hand over oven door. If heat is not felt, cancel bake function. If burner repeatedly fails to ignite, contact an authorized servicer.

Broiler Flame

Allow no more than 40–60 seconds before burner ignites and flame is seen. If burner does not ignite cancel broil function. If burner repeatedly fails to ignite within 40–60 seconds contact an authorized servicer.

Radiant screen style broiler flame should appear hazy or fuzzy. Haze should be no more than $\frac{3}{8}$ -inch thick. The radiant screen should begin to glow red within 1–2 minutes.

In Case of Fire

Fires can occur as a result of over cooking or excessive grease. Though a fire is unlikely, if one occurs, proceed as follows:

Oven Fires

1. If you see smoke from oven, do not open oven door.
2. Turn oven control to *OFF*.
3. As an added precaution, turn off gas supply and power at main circuit breaker or fuse box.
4. Turn on vent to remove smoke.
5. Allow food or grease to burn itself out in oven.
6. If smoke and fire persist, call fire department.
7. If there is any damage to components, call repair service before using oven.

If smoke or fire persist call the local fire department.

To avoid the risk of property damage or personal injury do not obstruct the flow of combustion or ventilation air to the oven.

To avoid the risk of electrical shock, serious personal injury or death: Make sure your oven has been properly grounded and always disconnect the electrical supply before servicing this unit.

Using the Oven

- Do not leave children alone or unattended where a range is hot or in operation. They could be seriously burned.
- Do not allow anyone to climb, stand or hang on the door. They could damage the range and cause severe personal injury.
- Wear proper apparel. Loose fitting or hanging garments should never be worn when using oven. Flammable material could ignite if brought in contact with flame or hot oven surfaces which may cause severe burns.
- Never use range for warming or heating a room. This

may cause burns, injuries, or a fire.

- Do not use water on grease fires.
- Do not let grease or other flammable materials collect in or around range.
- Do not repair or replace any part of range unless it is recommended in this manual.
- Use only dry potholders. Moist or damp potholders used on hot surfaces may result in a burn from steam. Do not let a potholder touch the flame. Do not use a towel or a bulky cloth as a potholder.
- Never leave range unattended while cooking. Boilovers can cause smoking and may ignite.
- Only certain types of glass/ceramic, earthenware, or other glazed utensils are suitable for use in gas ovens. Unsuitable utensils may break due to sudden temperature change.
- Use care when opening oven door. Let hot air or steam escape before removing or replacing food.
- Do not heat unopened food containers in oven. Build-up of pressure may cause a container to burst and result in injury.
- Keep range vent ducts unobstructed.
- Place oven racks in desired location while oven is cool. If a rack must be moved while oven is hot, use a dry potholder.
- Do not use aluminum foil to line oven bottom or racks. Aluminum foil can cause a fire and will seriously affect baking results, and damage to porcelain surface's.
- Do not touch interior surfaces of oven during or immediately after use. Do not let clothing or other flammable materials come in contact with bake or broil burners.
- Other areas of the oven can become hot enough to cause burns, such as vent openings, window, oven door and oven racks.
- To avoid steam burns, do not use a wet sponge or cloth to wipe up spills on hot cooking area.
- Do not store combustible or flammable materials, such as gasoline or other flammable vapors and liquids near or in oven.
- Do not clean oven door gasket located on back of the door. Gasket is necessary to seal the oven and can be damaged as a result of rubbing or being moved.
- Do not drape towels or any materials on oven door handles. These items may ignite causing a fire.



CAUTION

Do not store items of interest to children in cabinets above range. Children may climb on oven to reach these items and become seriously injured.

Safety Information

Connecting Range to Gas

Install manual shut-off valve in gas line for easy accessibility outside range. Be aware of the location of the shut-off valve.

Electrical Requirements

120-volt, 60 Hertz, 15 amp, individual circuit which is properly grounded, polarized and protected by a circuit breaker or fuse.

Extension Cord

Due to possible pinching during installation, extension cords should not be used on products.

Extension cords will adversely affect the performance of spark system.

Grounding

NOTE: This appliance must be properly grounded, for personal safety.

Power cord on this appliance is equipped with a three-prong grounding plug. This matches standard three-prong grounding wall receptacle to prevent possibility of electric shock from this appliance.

Consumer should have wall receptacle and circuit checked by qualified electrician to verify receptacle is properly grounded.

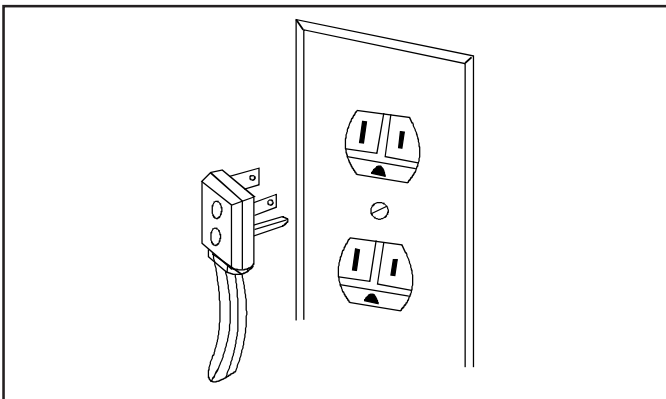

Where standard two-prong wall receptacle is encountered, it is consumers responsibility and obligation to have it replaced with a properly grounded three-prong wall receptacle.

DO NOT, UNDER ANY CIRCUMSTANCES, CUT OR REMOVE THE THIRD (GROUND) PRONG FROM POWER CORD.

For 15 amp circuits only. Do not use an adapter on 20 amp. circuit. Where local codes permit, a TEMPORARY CONNECTION may be made to properly grounded two-prong wall receptacle by the use of a UL listed adapter available at most hardware stores.

Larger slot on adapter must be aligned with larger slot in the wall receptacle to provide proper polarity.

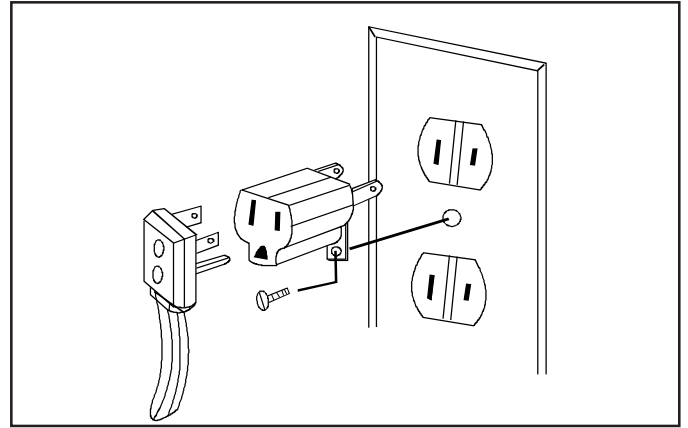

WARNING

Attaching adapter ground terminal to wall receptacle cover screw does not ground appliance unless the cover screw is metal and not insulated, and wall receptacle is grounded through the house wiring. Consumer should have circuit checked by a qualified electrician to verify receptacle is properly grounded.

When disconnecting power cord from adapter, always hold adapter with one hand. If this is not done, adapter ground terminal is very likely to break with repeated use. Should this happen, DO NOT USE appliance until a proper ground has been established.

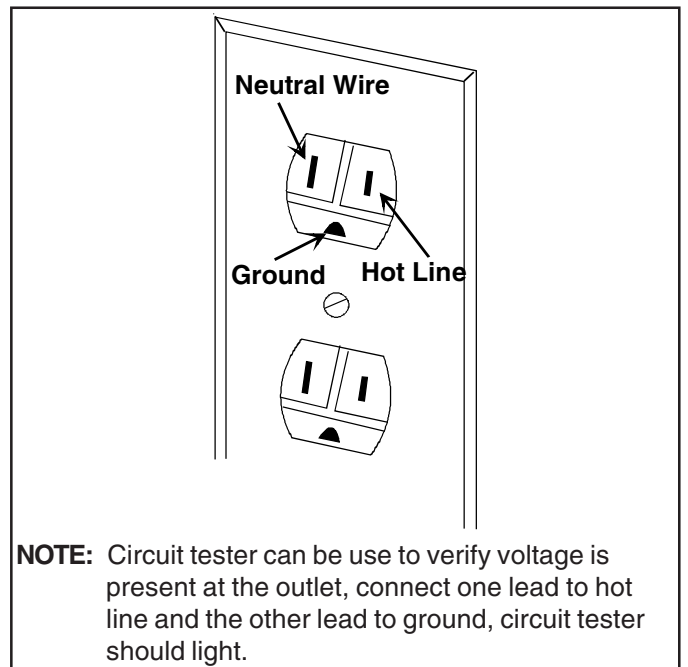

NOTE: Circuit tester can be use to verify voltage is present at the outlet, connect one lead to hot line and the other lead to ground, circuit tester should light.

Safety Information

Product Safety Devices

Safety devices and features have been engineered into the product to protect consumer and servicer. Safety devices must never be removed, bypassed, or altered in such a manner as to defeat the purpose for which they were intended.

Listed below are various safety devices together with the reason each device is incorporated in the gas ranges.

Pressure Regulator

Maintains proper and steady gas pressure for operation of oven controls. Regulator must be set for the type of gas being used **Natural** or **LP**. After servicing regulator, make certain it is set properly before completing service.

Gas Burner Orifices

Universal orifices are used on most valves. They must be adjusted or set for the type of gas being used **Natural** or **LP**. After servicing a valve or orifice verify it is adjusted properly before completing service.

Oven Safety Valve

Oven valve is designed to be a safety valve. Two basic designs are used in gas ranges.

Hydraulic type valve
Electric type valve

Both types are safety valves because they are indirectly operated by the oven thermostat, which controls a pilot flame or electric ignitor, to open and close the oven valve.

Grounded Oven Frame

Ground prong on power cord is connected to the frame, usually a green lead fastened by a screw. In addition, any part or component capable of conducting an electric current is grounded by its mounting.

If any ground wire, screw, strap, nut, etc. is removed for service, or any reason, it must be reconnected to its original position with original fastener before the appliance is put into operation again.

Failure to do so can create a possible shock hazard.

General Information

Model Identification

Complete registration card and promptly return. If registration card is missing:

- For Jade product call 1-866-820-9401 or visit the Web Site at www.jadeappliances.com

When contacting provide product information located on rating plate. Record the following:

Model Number: _____
Manufacturing Number: _____
Serial or S/N Number: _____
Date of purchase: _____
Dealer's name and address: _____

Service

Keep a copy of sales receipt for future reference or in case warranty service is required. To locate an authorized servicer:

- For Jade product call 1-866-820-9401 or visit the Web Site at www.jadeappliances.com

Warranty service must be performed by an authorized servicer. We also recommend contacting an authorized servicer, if service is required after warranty expires.

Parts and Accessories

Purchase replacement parts and accessories over the phone. To order accessories for your product call:

- For Jade product call 1-866-820-9401 or visit the Web Site at www.jadeappliances.com

Functional Operation

Bake or Broil Igniters

Bake and broil igniters are mounted to the bake and broil burners. They ignite the gas flowing into the burner.

During bake or broil operations, current flows through the ignitor, gas valve, and thermostat to neutral. As the ignitor heats up and starts glowing, it's internal resistance decreases. This allows more current to flow through the bake or broil circuit.

When circuit current reaches approximately 3.3 to 3.6 amperes. The bimetal arm in the gas valve flexes, opening the valve and allowing gas to flow to the burner, where it is ignited by the glowing ignitor. Igniters glow anytime bake or broil burners are operating and cycle on and off with the thermostat cycling contacts.

Gas Valve

Bake and broil dual gas valves supply gas to the bake and broil burners. Valves contain a bimetal arms attached to the valve seats. These arms are wrapped with a small electric heater coil. When current range of approximately 3.3 to 3.6 amper flows through the bake or broil circuit, the bimetal arm is heated. Heating causes the arm to bend, allowing gas to flow and be ignited by the burner ignitor.

Surface Burners, Griddle, Charbroil

One spark ignitor is used for each pair of burners. The ignitor is located between the flash tubes covered by a metal bracket to provide a grounding surface for ignition.

The surface burners have standard typical valves with a micro switch, which slides onto the shaft of the valve. When turning the surface valve to lite position, the internal shaft of the valve rotates and turns the micro switch on.

NOTE: If any surface valve is turned to lite position all electrodes will spark.

Spark System

The spark ignition system consists of a solid state module, spark ignitors, and micro switches.

By turning a surface burner knob to LITE position. The spark module sends approximately 2 sparks per second to the spark ignitors. This is achieved by turning the burner knob, which rotates the micro switch located on the valve stem. Which causes a demand for spark from the spark module containing an electronic circuit which produces high voltage pulses.

NOTE: When any surface burner is turned to the "ON" position all surface burners on that circuit will spark.

By turning a oven burner knob to LITE position. The spark module sends approximately 2 sparks per second to the spark ignitors. This is achieved by turning the burner knob, which rotates the micro switch located on the valve stem. Which causes a demand for spark from the spark module containing an electronic circuit which produces high voltage pulses.

Troubleshooting Procedures



WARNING

To avoid risk of electrical shock, personal injury or death; disconnect power and shut off gas to unit before servicing, unless testing requires power.

Problem	Possible Cause	Correction
Burners will not ignite; no spark at top burner.	Poor ground at ignitor..... Weak or failed spark module..... Low gas pressure.....	<ul style="list-style-type: none"> • Verify spark. • Replace spark module. • Verify pressure 4" WCP for natural, 10" WCP for LP.
Burner will not ignite. No spark to burner ignitors when burner knob is rotated to "LITE" position.	No 120 VAC to range Micro switch contacts not closing..... Faulty wiring. Bad connection at burner electrode and electrode socket Inoperative spark module..... Electrode dirty Cracked or broken electrode, electrode wire or electrode socket	<ul style="list-style-type: none"> • Verify voltage at wall outlet. • Check wiring against appropriate wiring diagram, Verify all terminals and connections are correct and tight. Check micro switch contacts. • Check wiring against appropriate wiring diagram. Verify all terminals and connections are correct and tight. • Check module according to testing procedures information. • Clean electrode. • Replace electrode.
No spark or only random spark at one ignitor.	Check for cracked ignitor or pinched ignitor wire Poor continuity to ignitor..... Bad ground connection or lack of continuity to ground or ignitor Cracked or broken ignitor extension lead ...	<ul style="list-style-type: none"> • Replace ignitor lead or electrode. • Verify spark. • Tighten ground connection and correct any breaks in ground path from ignitor path to unit ground path. • Replace ignitor lead.
Unit continues to spark after knob is turned to OFF position.	Shorted valve switch/harness Switch has slipped off the valve	<ul style="list-style-type: none"> • Replace switch/harness. If shorting is caused by excessive spillovers, customer education is advised. • Carefully reposition switch on valve and rotate from OFF to high, several times to verify switch is not broken.

Troubleshooting Procedures



WARNING

To avoid risk of electrical shock, personal injury or death; disconnect power and shut off gas to unit before servicing, unless testing requires power.







Problem	Possible Cause	Correction
No oven operation in bake or broil.	No voltage to control. Loose wire connection or broken wire.....	<ul style="list-style-type: none"> • Check for 120 VAC at control. If no voltage is present, Replace control. • Verify all connections are clean and tight, replace broken wire.
No gas flows to burner. Ignitor glows red.	Failed ignitor..... Gas pressure too high..... Failed gas valve..... Loose wire connection or broken wire.....	<ul style="list-style-type: none"> • Check ignitor current draw. Replace ignitor if it fails test. • Check for correct gas pressure. Natural gas pressure should be 4" WCP and LP gas pressure should be 10" WCP. • Check gas valve for continuity • Verify all connections are clean and tight, replace broken wire.
Gas flows to bake/broil burner, but burner does not light.	Ignitor positioned too far from burner..... Dirt or grease in orifice or burner..... Insufficient gas pressure..... Power outage.....	<ul style="list-style-type: none"> • Reposition ignitor closer to bake/broil burner. • Clean orifice or burner. • Check for correct gas pressure. Natural gas pressure should be 4" WCP and LP gas pressure should be 10" WCP. • Verify power is present at unit. Verify that the circuit breaker is not tripped. • Replace household fuse, but do not fuse capacity.
Oven light does not operate.	Failed oven lamp..... Failed wiring..... Failed light socket..... Failed light plunger.....	<ul style="list-style-type: none"> • Check lamp and replace is necessary. • Check for broken, loose or dirty connections. • Check light socket for continuity. • Check plunger for continuity.
Oven smokes/odor first few times of usage	Normal.....	<ul style="list-style-type: none"> • Minor smoking or odor is normal the first few times of oven usage. • Ventilate area well and perform self-clean cycle.
Fan motor does not operate.	No power to fan motor..... Failed fan motor or winding or frozen shaft.	<ul style="list-style-type: none"> • Check for 120 VAC supplied at fan motor. If no voltage is present, check for broken or loose wiring between fan motor and relay board. If voltage is present at fan motor, go to the next step. • Check motor winding for continuity. Check for a frozen motor shaft. Check for broken wiring between motor and neutral terminal block.

Component Testing Procedures

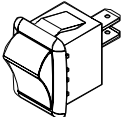
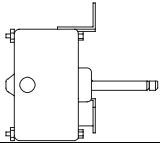

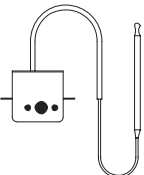
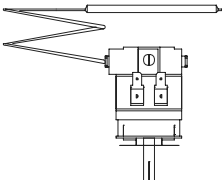
WARNING

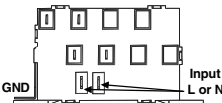
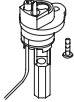
To avoid risk of electrical shock, personal injury or death; disconnect power and shut off gas to unit before servicing, unless testing requires power.

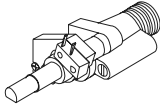

Illustration	Component	Test Procedure	Results
	Oven light housing	Disconnect connector and test resistance of terminals..... Measure voltage at oven light.....	Verify bulb is plugged in properly. Indicates continuity with bulb installed. 12 VAC, see wiring diagram for terminal identification. If no voltage is present at oven light, check wiring or light switches.
	Rocker switch	Measure continuity of switch positions: Closed Open	Continuity Infinite
	Convection motor fan	Verify supply voltage..... Check continuity of terminals, and verify terminals are not shorted to chassis.....	120 VAC Approximately 80 Ω
	Controls	Verify proper operation.	Open at 225°F, Closes at 165°F
	Griddle thermostat	Verify supply voltage.....	120 VAC
	Oven thermostat	Verify supply voltage.....	120 VAC
	Pressure regulator	Verify gas pressure (WCP). If on LP service, verify proper gas supply conversion.	5" Natural 10" LP/Propane
	Spark module 4 + 0	Test for voltage at terminals L and N..... Polarity and ground	120 VAC Not subject to polarity
	Holder orifice	Verify gas pressure (WCP). Check orifice for debris.	5" Natural 10" LP/Propane Clean as needed.
	Spark ignition electrode	Test for resistance of spark lead Test ignitor to chassis	Continuity No continuity from ignitor to chassis.

Component Testing Procedures



WARNING

To avoid risk of electrical shock, personal injury or death; disconnect power and shut off gas to unit before servicing, unless testing requires power.

Illustration	Component	Test Procedure	Results
	270° valve	Verify gas is supplied. Orifice adjusted for Natural or LP. Adjust set screw for simmer control.	See conversion section.
	Spark 270° switch	Unplug switch harness at rear of range. Test for continuity at wire terminals. Switch in LITE position..... Switch in any other position	120 VAC Continuity Infinite
	Top surface burner	Verify gas is supplied Verify burner cap is positioned correctly.	Check for obstructions in burner ports.

Disassembly Procedures



WARNING

To avoid the risk of electrical shock, personal injury or death; disconnect power to oven and shut off gas supply before following any disassembly procedure.

Removing and Replacing Unit

1. Turn off gas and power supply to the oven.

NOTE: To avoid property damage, place a protective covering on the floor.

2. Slide unit forward, out of the installation position.
3. Disconnect or unplug the power cord leading from unit to junction box or outlet depending on connection.
4. Turn off gas supply and disconnect from main gas line.
5. Reinstall oven, using Installation Instructions.

Knob Bezel(s)

1. Turn off gas and power supply to the oven.
2. Remove surface burner knobs from control panel, by pulling knobs straight off.
3. Remove oven control knobs from control panel.
 - Rotating knob to gain access to set screw.
 - Loosen set screw on knob.
 - Rotate knob to "OFF" position and remove.
4. Remove screws securing knob bezel to control panel.
5. Replace component and reverse procedures to reassemble.

Control Panel, Rocker Switch(es), and Indicator Light(s)

1. Turn off gas and power supply to the oven.
2. Remove surface burner knobs from control panel, by pulling knobs straight off.
3. Remove oven control knobs from control panel.
 - Rotating knob to gain access to set screw.
 - Loosen set screw on knob.
 - Rotate knob to "OFF" position and remove.
4. Remove screws securing control panel cover to chassis.
5. Roll top portion of control panel cover downward to gain access to components.
6. Disconnect and label wire terminals from rocker switches.
7. Slide indicator lights to the side to release from holders.

NOTE: Once an indicator light is released from the holder the front lens will fall out.

Surface Burner Micro Switch(es)

1. Turn off gas and power supply to the oven.
2. Release control panel cover, see "Control Panel" procedure, steps 1 through 5.
3. Disconnect and label wire terminals from micro switch located on the burner valve.
4. Remove micro switch from burner valve, by pulling switch from burner valve.
5. Replace component and reverse procedure to reassemble.

Surface Burner Valve(s)

1. Release control panel cover, see "Control Panel" procedure, steps 1 through 5.
2. Remove micro switch from burner valve.
3. Disconnect gas line from surface valve.
4. Unscrew burner valve from manifold pipe.

NOTE: Some additional components maybe required to be disconnected or removed. This will allow access for valve to be unscrewed from manifold pipe.

5. Replace component and reverse procedure to reassemble.

NOTE: When installing valve, use pipe dope compound. Perform gas leak test to ensure unit will not leak and unit operates properly.

Oven and Surface Broiler Infinite Switch

1. Turn off gas and power supply to the oven.
2. Release control panel cover, see "Control Panel" procedure, steps 1 through 5.
3. Disconnect clips securing sensor bulb.
4. Remove screws securing switch to mounting bracket.
5. Disconnect and label wire terminals from switch.
6. Slowly guide sensor bulb from unit.
7. Replace component and reverse procedures to reassemble.

NOTE: Perform gas leak test to ensure unit will not leak and unit operates properly.

Disassembly Procedures



WARNING

To avoid the risk of electrical shock, personal injury or death; disconnect power to oven and shut off gas supply before following any disassembly procedure.

Spark Module

1. Turn off gas and power supply to the oven.
2. Release control panel cover, see "Control Panel" procedure, steps 1 through 5.
3. Locate spark module, looking through control panel inside the burner box area at the rear of the unit.
4. Remove surface module located on top of spark module, to gain access to spark module.

NOTE: Disconnect gas line at the surface valve for module removal.

5. Remove screws securing spark module mounting bracket to back of unit. Allow mounting bracket to fall into burner box area.
6. Disconnect and label wire terminals from spark module.
7. Release plastic tabs securing spark module to mounting bracket.
8. Replace component and reverse procedures to reassemble.

NOTE: Perform gas leak test to ensure unit will not leak and unit operates properly.

Module(s) Removal

1. Remove top assembly pieces from module.
2. Disconnect and label wire terminals from module.
3. Disconnect gas line from the surface valve.
4. Raise upward on the rear of the module and side back slightly to release module from orifice and place to the side.
5. Reverse procedure to reassemble.

Oven Light Socket

1. Turn off gas and power supply to the oven.
2. Identify location of failed oven light.
 - If located on an outside oven wall, remove appropriate side panel, to gain access to oven light, see "Side Panel" procedure.
 - If located on oven interior wall,
3. Disconnect and label wire terminals from light socket.
4. Open oven door and remove light lens cover from light socket.
5. Release metal tabs on light socket and allow light socket to release into the oven cavity area.
6. Replace component and reverse procedure to assemble.

Convection Fan

1. Open oven door and remove oven racks from the oven cavity.
2. Remove screws securing convection fan cover to the rear of the oven cavity.
3. Raise upward on convection fan cover to release from supporting bracket.
4. Remove bolts securing convection fan to mounting bracket.
5. Pull convection fan into oven cavity area and place to the side.
6. Reach through convection fan hole located in the rear of the oven cavity, following the wires.
7. Locate the terminal wire plug, squeeze the side of the terminal plug and pull to release.
8. Remove convection fan from the oven cavity.
9. Loosen set screw securing the fan blade to the convection fan shaft and remove fan blade.
10. Remove nuts securing convection fan to the mounting bracket.
11. Replace component and reverse procedures to reassemble.

NOTE: When securing fan blade to the new convection fan shaft allow approximately 1/4" from the mounting bracket. Spin fan blade to ensure blade spins freely.

Bake Burner and Ignitor

1. Shut off power and gas supply to unit.
2. Remove kick plate from under oven needing servicing.
3. Disconnect and label wire terminals from gas valve.
4. Remove items and oven racks from oven cavity.
5. Grasp front corners of oven bottom, lift and pull forward to remove from oven cavity.
6. Remove screw securing bake burner to oven chassis, located at the rear of oven cavity.
7. Grasp burner and slide to the rear, while maneuvering burner to either side to release from burner orifice.
8. Remove screws and nuts securing ignitor to bake burner.
9. Replace component and reverse procedure to reassemble.

Disassembly Procedures



WARNING

To avoid the risk of electrical shock, personal injury or death; disconnect power to oven and shut off gas supply before following any disassembly procedure.

Broil Burner and Ignitor

1. Shut off power and gas supply to unit.
2. Release control panel cover, see "Control Panel" procedure, steps 1 through 5.
3. Remove surface modules located over broiler.
4. Remove screws securing heat reflector.
5. Disconnect gas line from broiler.
6. Remove screws securing broiler ignitor to oven cavity.
7. Remove screws securing broiler to oven cavity.
8. Loosen screws securing rear broiler guards to oven cavity.
9. Remove screws securing front of broiler guards to oven cavity.
10. Slide front portion of broiler guards outward to gain access to broiler.
11. Remove broiler from oven cavity.
12. Replace component and reverse procedure to reassemble.

Bake Gas Valve(s)

NOTE: Located behind kick plate area.

1. Shut off power and gas supply to unit.
2. Remove kick plate from under oven needing servicing.
3. Disconnect and label wire terminals from gas valve.
4. Disconnect fuel lines connected to gas valve.
5. Remove screws securing gas valve bracket to unit chassis.
6. Replace component and reverse procedure to reassemble.

NOTE: Perform gas leak test to ensure unit will not leak and unit operates properly.

Broiler Gas Valve(s)

NOTE: Located in the surface burner box area.

1. Shut off power and gas supply to unit.
2. Release control panel cover, see "Control Panel" procedure, steps 1 through 5.
3. Remove surface module top portion from surface module to gain access to gas valve.
4. Disconnect and label wire terminals from gas valve.
5. Disconnect gas lines connected to gas valve.
6. Remove screws securing gas valve bracket to unit chassis.
7. Replace component and reverse procedure to reassemble.

NOTE: Perform gas leak test to ensure unit will not leak and unit operates properly.

Backguard

NOTE: This procedure requires removal of unit from installation position.

- Remove screws securing panel to backguard, located on the back of the unit.

Top Side Panel

1. Remove top portion of module from unit, located next to the side needing replaces.
2. Remove screws securing top side panel to the chassis.
3. Replace component and reverse procedure to reassemble.

Side Panel

NOTE: This procedure requires removal of unit from installation position.

1. Remove top side panel, see "Top Side Panel" procedure.
2. Remove screws securing top, bottom, and rear of side panel to the chassis.
3. Pull outward on the back of the side panel and slide panel to the rear to release side panel from the chassis.
4. Replace component and reverse procedures to reassemble.

Disassembly Procedures



WARNING

To avoid the risk of electrical shock, personal injury or death; disconnect power to oven and shut off gas supply before following any disassembly procedure.

Door Removal

1. Remove bottom kick plate.
 - Pull outward on bottom portion of the kick plate to release.
 - Push upward on kick plate to release and remove from unit.
2. Release tension spring on door hinge, by completely removing nut from eyebolt.
3. Remove eyebolt from hinge hanger.
4. Remove hinge hanger from door hinge.

NOTE: Once hinge bolts are removed, oven door will fall. Secure oven door before removing hinge bolts.

5. Remove bolts securing door hinge to chassis.
 - Located behind oven door hinges is a metal spacer.
6. Remove door from unit.

Door Disassembly

1. Remove oven door, see "Door Removal" procedure.
2. Place door on a protected surface to prevent damaging the oven door.
3. Remove screws securing the bottom and sides of the door.

NOTE: Located on the side screws is a nut used a spacer between outer shell and inner door assembly.

4. Carefully pry the bottom corners outward on outer shell to allow outer shell to bypass door hinges.
5. Remove screws securing door handle and replace if necessary.
6. Remove screws securing outer door glass and replace if necessary.
7. Remove screws securing inner door glass brackets and replace glass if necessary.
8. Remove nuts securing inner door wrapper to inner door.
9. Remove insulation to gain access to inner window assembly.
10. Remove nuts securing inner window assembly and replace if necessary.
11. Replace component and reverse procedures to reassemble.

Gas Regulator

1. Turn off gas and power supply to the oven.
2. Remove surface module, located on the right side of unit. See module type for removal procedures.

NOTE: Complete disassembly of module may not be required to gain access to gas regulator.

3. Disconnect all gas lines from gas regulator.
4. Replace component and reverse procedure to reassemble.

NOTE: When installing, use pipe dope compound. Perform gas leak test to ensure unit will not leak and unit operates properly.

Manifold Pipe

1. Turn off gas and power supply to the oven.
2. Release control panel cover, see "Control Panel" procedure, steps 1 through 5.
3. Remove micro switches from all surface valves.
4. Cut plastic ties securing wiring to manifold pipe.
5. Disconnect gas lines, at the union from manifold pipe.
6. Remove bolts securing gas manifold to burner box.
7. Remove surface valves from manifold pipe.
8. Replace component and reverse procedure to reassemble.

NOTE: When installing valve, use pipe dope compound. Perform gas leak test to ensure unit will not leak and unit operates properly.

Disassembly Procedures



WARNING

To avoid the risk of electrical shock, personal injury or death; disconnect power to oven and shut off gas supply before following any disassembly procedure.

Front Facade

This piece is spot welded into place, so it is not replaceable.

Module Type

Surface Burner

1. Turn off gas and power supply to the oven.
2. Remove grates and burner caps from module.
3. Remove screw securing burner assembly to the mounting bracket.
4. Remove screw securing ignitor to burner mounting bracket.
5. Disconnect wire terminal from ignitor.
6. Replace component and reverse procedure to reassemble.

Charboil

1. Turn off gas and power supply to the oven.
2. Remove grates from module.
3. Release control panel cover, see "Control Panel" procedure, steps 1 through 5.
4. Disconnect gas lines from surface valve.
5. Disconnect and label wire terminals from gas valve.
6. Remove screws securing gas module to mounting bracket.
7. Remove screws securing ignitor to module.
8. Remove nuts securing burner mounting bracket to module.
9. Remove burner from module.
10. Replace component and reverse procedure to reassemble.

Griddle

1. Turn off gas and power supply to the oven.
2. Remove griddle from module.
3. Remove screws securing ignitor to module.
4. Remove screw securing burner to module.
5. Remove burner from module.
6. Replace component and reverse procedure to reassemble.

Disassembly Procedures



WARNING

To avoid the risk of electrical shock, personal injury or death; disconnect power to oven and shut off gas supply before following any disassembly procedure.

This page is intentionally left blank.