

This Owner's Manual is provided and hosted by [Appliance Factory Parts](http://Appliance Factory Parts).

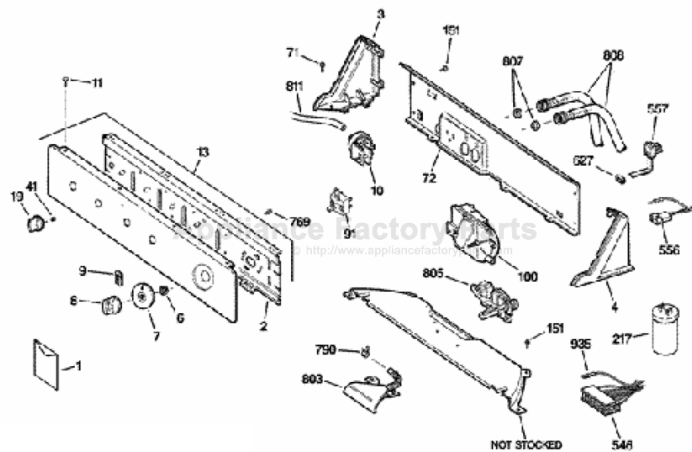

# Hotpoint VBXR1090D2WW Owner's Manual

[Shop genuine replacement parts for Hotpoint  
VBXR1090D2WW](#)



[Find Your Hotpoint Washer Parts - Select From 171 Models](#)

----- Manual continues below -----

# Washers

**Safety Instructions** ..... 2

**Operating Instructions**

Control Panels .....3-5  
Control Settings ..... 4, 6  
Features .....7  
Loading and Using  
the Washer .....8, 9

**Troubleshooting Tips** .... 10-12

**Consumer Support**

Consumer Support ..... Back Cover  
Product Registration ..... 13, 14  
Warranty ..... 15

**Owner's Manual**

WSR1070  
VBXR1090  
VBSR3100  
VWSR4150  
VLXR1020  
VWSR1030

**Write the model and serial numbers here:**

**Model #** \_\_\_\_\_

**Serial #** \_\_\_\_\_

You can find them behind the control panel  
on the back of your washer.

# IMPORTANT SAFETY INFORMATION. READ ALL INSTRUCTIONS BEFORE USING.

**⚠ WARNING!** For your safety, the information in this manual must be followed to minimize the risk of fire or explosion, electric shock, or to prevent property damage, personal injury, or loss of life.



## WATER HEATER SAFETY

Under certain conditions hydrogen gas may be produced in a water heater that has not been used for two weeks or more. Hydrogen gas can be explosive under these circumstances.

If the hot water has not been used for two weeks or more, prevent the possibility of damage or injury by turning on all hot water faucets and allowing them to run for several minutes. Do this before using any electrical appliance which is connected to the hot water system. This simple procedure will allow any built-up hydrogen gas to escape. Since the gas is flammable, do not smoke or use an open flame or appliance during this process.



## PROPER INSTALLATION

This washer must be properly installed and located in accordance with the Installation Instructions before it is used. If you did not receive an Installation Instructions sheet, you can receive one by visiting [www.Hotpoint.com](http://www.Hotpoint.com), or by calling **800.GE.CARES (800.432.2737)**.

- Install or store where it will not be exposed to temperatures below freezing or exposed to the weather.
- Properly ground washer to conform with all governing codes and ordinances. Follow details in Installation Instructions.



## YOUR LAUNDRY AREA

■ Keep the area underneath and around your appliances free of combustible materials such as lint, paper, rags, chemicals, etc.

- Close supervision is necessary if this appliance is used by or near children. Do not allow children to play on, with, or inside this or any other appliance.



## WHEN USING THE WASHER

Use this appliance only for its intended purpose as described in this Owner's Manual.

■ Never reach into washer while it is moving. Wait until the machine has completely stopped before opening the lid.

■ Do not mix chlorine bleach with ammonia or acids such as vinegar and/or rust remover. Mixing different chemicals can produce a toxic gas which may cause death.

■ Do not wash or dry articles that have been cleaned in, washed in, soaked in, or spotted with combustible or explosive substances (such as wax, oil, paint, gasoline, degreasers, dry-cleaning solvents, kerosene, etc.) which may ignite or explode. Do not add these substances to the wash water. Do not use or place these substances around your washer or dryer during operation.

■ The laundry process can reduce the flame retardancy of fabrics. To avoid such a result, carefully follow the garment manufacturer's wash and care instructions.

■ To minimize the possibility of electric shock, unplug this appliance from the power supply or disconnect the washer at the household distribution panel by removing the fuse or switching off the circuit breaker before attempting any maintenance or cleaning. **NOTE:** Turning the Cycle Selector knob to an off position or pressing PAUSE does **NOT** disconnect the appliance from the power supply.

■ Never attempt to operate this appliance if it is damaged, malfunctioning, partially disassembled, or has missing or broken parts, including a damaged cord or plug.



## WHEN NOT IN USE

■ Turn off water faucets to relieve pressure on hoses and valves and to minimize leakage if a break or rupture should occur. Check the condition of the fill hoses; they should be replaced every 5 years.

■ Before discarding a washer, or removing it from service, remove the washer lid to prevent children from hiding inside.

■ Do not attempt to repair or replace any part of this appliance unless specifically recommended in this Owner's Manual, or in published user-repair instructions that you understand and have the skills to carry out.

■ Do not tamper with controls.



**READ AND FOLLOW THIS SAFETY INFORMATION CAREFULLY.  
SAVE THESE INSTRUCTIONS**

# About the washer control panel.

(models VVSR1070, VBXR1090, VBSR3100, VLXR1020, VVSR1030)

www.Hotpoint.com

You can locate your model number on the back of your washer, behind the control panel.

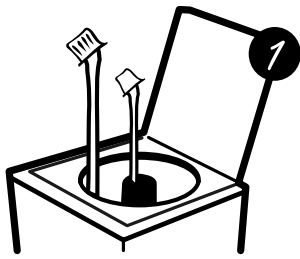

- Add detergent
- Add diluted fabric softener (on models with a fabric softener dispenser)

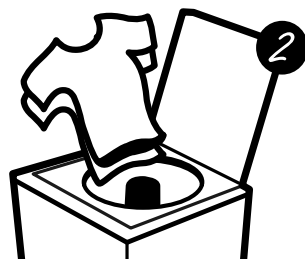

- Add clothes



- Select load size and other wash options
- Select wash cycle

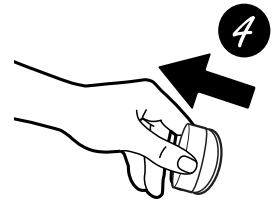

- Close lid
- Pull knob

## Quick Start Guide

### Model VVSR1070

**LOAD SIZE**

**WASH CYCLE DIAL**

### Model VBXR1090

**LOAD SIZE**

**TEMPERATURE**

**WASH CYCLE DIAL**

### Model VBSR3100

**LOAD SIZE**

**TEMPERATURE**

**WASH CYCLE DIAL**

# About the washer control panel.

(models VVSR1070, VBXR1090, VBSR3100, VLXR1020, VVSR1030)

## Model VVSR1030



# About the washer control panel.

(models VVSR1070, VBXR1090, VBSR3100, and VLXR1020)

## Model VLXR1020



# Control settings.



### Load Size

Loosely load clothes no higher than the top row of holes in the washer basket. The water level should just cover the clothes. Adjust the load size accordingly.



### Temperature

Select the water temperature for the wash and rinse cycles. On some models, the temperature is controlled by the wash cycle knob. Always follow fabric manufacturer's care label or instructions when laundering.



### Wash Cycle (on some models)

The wash cycle controls the length of the washing process. The chart below will help you match the wash cycle setting with your clothing.

**COTTONS** For heavy to lightly soiled cottons, household linens, work and play clothes.

**WRINKLE FREE** For easy care, wrinkle-free and permanent press items.

**KNITS** Specially designed for normally soiled knits.

**DELICATES** For lingerie and special-care fabrics with light to normal soil.

# About the washer control panel.

(model VWSR4150)

www.Hotpoint.com

You can locate your model number on the back of your washer, behind the control panel.

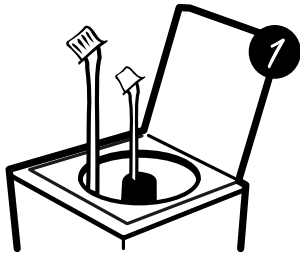

- Add detergent
- Add diluted fabric softener (on models with a fabric softener dispenser)

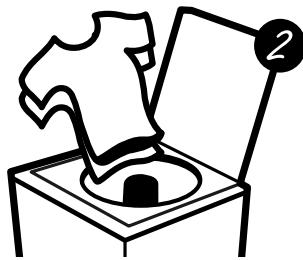

- Add clothes

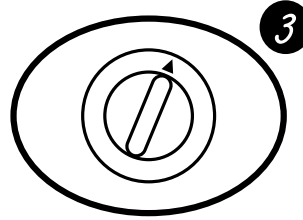

- Select load size and other wash options
- Select wash cycle

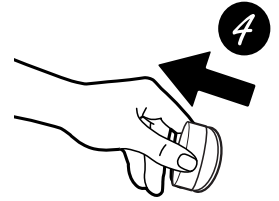

- Close lid
- Pull knob

## Quick Start Guide

### Model VWSR4150

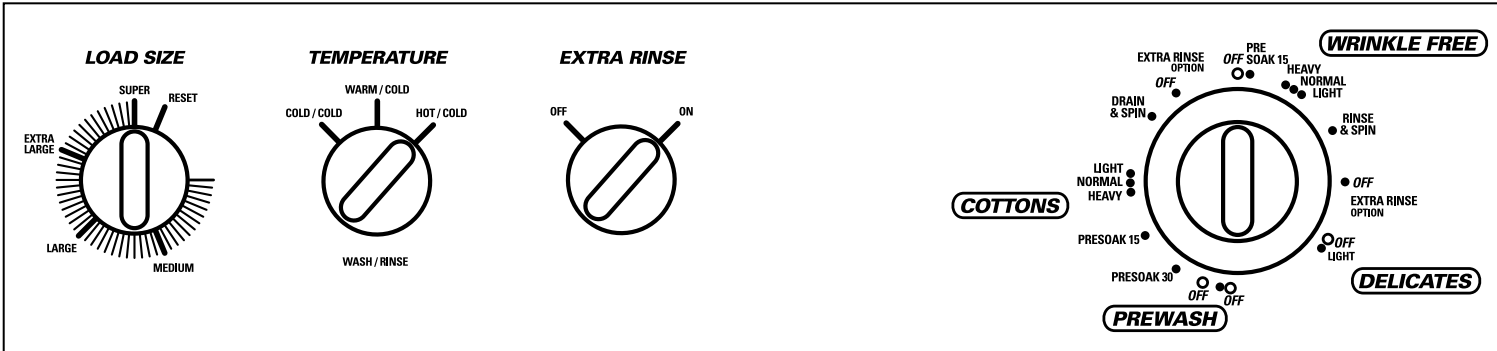

The diagram shows the control panel with the following settings:

- LOAD SIZE:** SUPER, RESET, EXTRA LARGE, LARGE, MEDIUM.
- TEMPERATURE:** WARM / COLD, COLD / COLD, HOT / COLD, WASH / RINSE.
- EXTRA RINSE:** OFF, ON.
- Wash Cycle:** COTTONS, PREWASH, DELICATES, WRINKLE FREE.
- Options:** EXTRA RINSE OPTION, PRE SOAK 15, HEAVY, NORMAL, LIGHT, RINSE & SPIN, OFF EXTRA RINSE OPTION, OFF LIGHT, PRE SOAK 30, OFF, OFF, DRAIN & SPIN, LIGHT, NORMAL, HEAVY, PRESOAK 15, PRE SOAK 30, OFF, OFF.

## Control settings.



### **Load Size** (on some models)

Loosely load clothes no higher than the top row of holes in the washer basket. The water level should just cover the clothes. Adjust the load size accordingly.



### **Temperature**

Select the water temperature for the wash and rinse cycles. Always follow fabric manufacturer's care label or instructions when laundering.



### **Custom Care**

The agitator moves clothes around for a cleaner wash; the basket spins later in the cycle to release water from the load. The Wash/Spin Speed dial sets the speed of both the agitator and the basket.

#### **Wash Speeds:**

*With Normal wash speed*, the agitator will move at a higher speed. Use for cottons, denims and play clothes.

*With Gentle wash speed*, the agitator moves slower. Use for delicate and knit items.

#### **Spin Speeds:**

*The Fast spin speed* is for normal items. Use it to remove more water from your clothes to allow them to dry faster in the dryer.

*The Slow spin speed* is for delicate items like sweaters and lingerie. When using Slow spin speed, clothes will be less dry than when using Fast spin speed.



### **Wash Cycle**

The wash cycle controls the length of the washing process. The chart below will help you match the wash cycle setting with your clothing.

---

**COTTONS** For heavy to lightly soiled cottons, household linens, work and play clothes.

---

**WRINKLE FREE** For easy care, wrinkle-free and permanent press items.

---

**DELICATES** For lingerie and special-care fabrics with light to normal soil.

---

**PREWASH** For heavily soiled clothes or for clothes with a care label that recommends prewashing before washing.

---

### **Extra Rinse**

When you use extra detergent or bleach to clean heavily soiled clothes, you may want to use the Extra Rinse option.

This option provides a second deep cold rinse in the **COTTONS** and **WRINKLE FREE** cycles. Turn the Extra Rinse knob to **ON**.

*The washer will pause for a few minutes before the Extra Rinse option begins.*

# About the washer features.

NOTE: Not all features are available on all washer models.

www.Hotpoint.com



## The Agitator Cap or Fabric Softener Dispenser (depending on model)

**The agitator cap** fits into the top of the agitator. If it accidentally comes off, simply put it back on.

**The fabric softener dispenser** automatically releases liquid fabric softener at the proper time during the cycle.

**Do not stop the washer during the first spin. This will cause the dispenser to empty too soon.**

To use, follow these steps:

- 1 Make sure dispenser is securely attached to agitator.
- 2 Use only liquid fabric softener.  
Pour into dispenser, using amount recommended on package.

**Never pour fabric softener directly on clothes. It may stain them.**

- 3 Add water to dispenser until it reaches the maximum fill line.

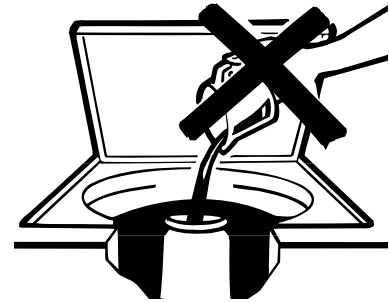

Do not pour anything into the agitator if the agitator cap or dispenser is removed.

## Cleaning the Fabric Softener Dispenser (depending on model)

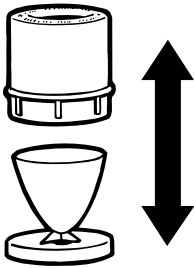

Separate for cleaning

- 1 Remove the dispenser from the top of the agitator.
- 2 Separate the dispenser cup from the cover by grasping the top and pushing down on the inside of the cup with your fingers. Dispenser cup will pop free from the cover.
- 3 To clean the dispenser, soak both the dispenser cup and the dispenser cover in the following solution:
  - 1 US gallon (3.8 liters) warm water
  - 1/4 cup (60 ml) heavy duty liquid detergent
  - 1 cup (240 ml) bleach
- 4 If necessary, loosen build-up with a clean, soft cloth after soaking. Do not use a stiff brush; you may roughen the surface of the dispenser.
- 5 Rinse and reassemble dispenser. Place dispenser back on the agitator.

## Liquid Bleach Dispenser (depending on model)

The dispenser dilutes liquid chlorine bleach before it reaches into your wash load.

- 1 Check clothing care labels for special instructions.
- 2 Measure liquid bleach carefully, following instructions on the bottle.
  - Never pour undiluted liquid chlorine bleach directly onto clothes or into the wash basket.
  - Do not pour powdered bleach into bleach dispenser.
- 3 Before starting the washer, pour measured amount of bleach directly into bleach dispenser. Avoid splashing or over-filling dispenser. If you prefer to use powdered bleach, add it into the wash basket with your detergent.
  - Do not mix chlorine bleach with ammonia or acids such as vinegar and/or rust remover. Mixing can produce a toxic gas which may cause death.

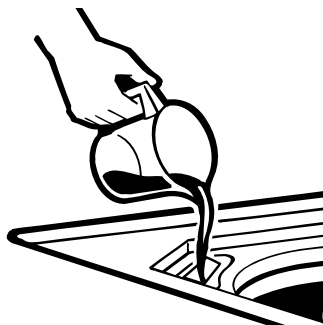

## Loading and using the washer.

Always follow fabric manufacturer's care label when laundering.



### Sorting Wash Loads

Sort by color (whites, lights, colors), soil level, fabric type (sturdy cottons, easy care, delicates), and whether the fabric produces lint (terry cloth, chenille), or collects lint (velveteen, corduroy).

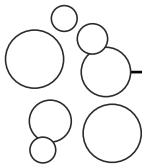

### Proper Use of Detergent

Add detergent and start the washer before adding clothes so that the detergent can work effectively. Using too little or too much detergent is a common cause of laundry problems.

You can use less detergent if you have soft water, a smaller load, or a lightly soiled load.



### Loading the Washer

Load dry items loosely, no higher than the top row of holes in the washer basket. When loading wet items make sure you set the load/water level high enough to allow the items to move freely. Water level should just cover the clothes. To add items after washer has started, push in Cycle knob and submerge additional items next to the agitator. Close the lid and pull Cycle knob out to restart.

- Do not wrap long items like sheets or pants around the agitator.
- Do not wash fabrics containing flammable materials (waxes, cleaning fluids, etc.).
- Water will fill and pump out of the washer and the timer will advance with the lid up, but as a safety precaution the washer will not agitate or spin.



## Care and Cleaning of the Washer

**Wash Basket:** Leave the lid open after washing to allow moisture to evaporate. If you want to clean the basket use a clean soft cloth dampened with liquid detergent, then rinse. (Do not use harsh or gritty cleaners.)

**Fill Hoses:** Hoses connecting washer to faucet should be replaced every 5 years.

**Exterior:** Immediately wipe off any spills. Wipe with damp cloth. Try not to hit surface with sharp objects.

**Moving and Storage:** Ask the service technician to remove water from drain pump and hoses. See the Installation Instructions packed with product for information on how to reinstall the shipping rod to keep the tub stationary when moving the washer. For more information, visit [www.Hotpoint.com](http://www.Hotpoint.com), or call **800.GE.CARES** (800.432.2737). Do not store the washer where it will be exposed to the weather.

**Long Vacations:** Be sure water supply is shut off at faucets. Drain all water from hoses if weather will be below freezing.



## Fabric Care Labels

Below are fabric care label “symbols” that affect the clothing you will be laundering.

### WASH LABELS

<b>Machine wash cycle</b>						
	Normal	Permanent Press/ wrinkle resistant	Gentle/ delicate	Hand wash	Do not wash	Do not wring
<b>Water temperature</b>						
	Hot (50°C/120°F)		Warm (40°C/105°F)		Cold/cool (30°C/85°F)	

### DRY LABELS

<b>Tumble dry</b>						
	Dry	Normal	Permanent Press/ wrinkle resistant	Gentle/ delicate	Do not tumble dry	Do not dry (used with do not wash)
<b>Heat setting</b>						
	High	Medium	Low	No heat/air		
<b>Special instructions</b>						
	Line dry/ hang to dry	Drip dry	Dry flat	In the shade		

### BLEACH LABELS

<b>Bleach symbols</b>			
	Any bleach (when needed)	Only non-chlorine bleach (when needed)	Do not bleach

## Before you call for service...



### Troubleshooting Tips

Save time and money! Review the charts on the following pages, or visit [www.Hotpoint.com](http://www.Hotpoint.com). You may not need to call for service.

<b>WATER</b>	<b>Possible Causes</b>	<b>What To Do</b>
<b>Too many suds</b>	Type of detergent	<ul style="list-style-type: none"> <li>Switch to a lower sudsing detergent brand and follow instructions on package.</li> </ul>
	Very soft water	<ul style="list-style-type: none"> <li>Try less detergent.</li> </ul>
	Too much detergent	<ul style="list-style-type: none"> <li>Measure your detergent carefully. Use less soap if you have soft water, a smaller load, or a lightly soiled load.</li> </ul>
<b>Water leaks</b>	Fill hoses or drain hose is improperly connected	<ul style="list-style-type: none"> <li>Make sure hose connections are tight at faucets and rubber washers are installed. Make sure end of drain hose is correctly inserted in and secured to drain facility.</li> </ul>
	Household drain may be clogged	<ul style="list-style-type: none"> <li>Check household plumbing. You may need to call a plumber.</li> </ul>
	Constant water pressure to the fill hoses at the water source	<ul style="list-style-type: none"> <li>Tighten hoses at the faucets and turn the water off after each use.</li> <li>Check condition of the fill hoses; they should be replaced every 5 years.</li> </ul>
	Using too much detergent in washer	<ul style="list-style-type: none"> <li>Use less detergent. Use less soap if you have soft water, a smaller load, or a lightly soiled load.</li> </ul>
<b>Water temperature seems incorrect</b>	Cooler water temperatures provide improved energy efficiency	<ul style="list-style-type: none"> <li>New laundry detergents have been formulated to work with cooler water temperatures without affecting wash performance.</li> </ul>
	Control is not set properly	<ul style="list-style-type: none"> <li>Check water temperature control (on some models) or Cycle knob and adjust.</li> </ul>
	Water supply is turned off or improperly connected	<ul style="list-style-type: none"> <li>Turn both hot and cold faucets fully on and make sure hoses are connected to correct faucets.</li> </ul>
	Water valve screens are stopped up	<ul style="list-style-type: none"> <li>Turn off the water source and remove the water connection hoses from the upper back of the washer. Use a brush or toothpick to clean the screens in the machine. Reconnect the hoses and turn the water back on.</li> </ul>
	House water heater is not set properly	<ul style="list-style-type: none"> <li>Make sure house water heater is delivering water at 120°F–140°F (48°C–60°C).</li> </ul>
<b>Water won't drain</b>	Drain hose is kinked or improperly connected	<ul style="list-style-type: none"> <li>Straighten drain hose and make sure washer is not sitting on it.</li> <li>Top of drain outlet should be less than 8 ft. (2.5 m) above floor.</li> </ul>

<b>OPERATION</b>	<b>Possible Causes</b>	<b>What To Do</b>
<b>Washer pauses during wash cycle</b>	The washer normally pauses between washing steps	
<b>Washer pauses during spin cycle</b>	This is normal	<ul style="list-style-type: none"> <li>The washer may pause during the spin cycle to remove soapy water more efficiently.</li> </ul>
<b>Washer won't operate</b>	Washer is unplugged	<ul style="list-style-type: none"> <li>Make sure cord is plugged securely into a working outlet.</li> </ul>
	Water supply is turned off	<ul style="list-style-type: none"> <li>Turn both hot and cold faucets fully on.</li> </ul>
	Controls are not set properly	<ul style="list-style-type: none"> <li>Check controls and make sure Cycle knob is pulled out to <b>ON</b> position.</li> </ul>
	Lid is open—safety feature prevents agitation and spinning when lid is up	<ul style="list-style-type: none"> <li>Close lid and reset cycle, to the beginning if necessary.</li> </ul>
	Circuit breaker/fuse is tripped/blown	<ul style="list-style-type: none"> <li>Check house circuit breakers/fuses. Replace fuses or reset breaker. Washer should have separate outlet.</li> </ul>
<b>PERFORMANCE</b>	<b>Possible Causes</b>	<b>What To Do</b>
<b>Colored spots</b>	Incorrect use of fabric softener	<ul style="list-style-type: none"> <li>Check fabric softener package for instructions and follow directions for using dispenser.</li> <li>Pretreat stain and rewash.</li> </ul>
	Dye transfer	<ul style="list-style-type: none"> <li>Sort whites or lightly colored items from dark colors.</li> </ul>
<b>Grayed or yellowed clothes</b>	Not enough detergent	<ul style="list-style-type: none"> <li>Use more detergent (especially with larger loads). Be sure to follow detergent manufacturer's directions.</li> </ul>
	Hard water	<ul style="list-style-type: none"> <li>Use a water conditioner like Calgon brand or install a water softener.</li> </ul>
	Water is not hot enough	<ul style="list-style-type: none"> <li>Make sure water heater is delivering water at 120°F–140°F (48°C–60°C).</li> </ul>
	Washer is overloaded	<ul style="list-style-type: none"> <li>Select load size to match clothes load.</li> </ul>
	Detergent is not dissolving	<ul style="list-style-type: none"> <li>Add detergent as wash basket fills with water before you load clothes.</li> </ul>
	Dye transfer	<ul style="list-style-type: none"> <li>Sort clothes by color. If fabric label states <i>wash separately</i>, unstable dyes may be indicated.</li> </ul>
<b>Lint or residue on clothes</b>	Clothes are air or line dried	<ul style="list-style-type: none"> <li>If you do not dry your clothes with a clothes dryer, your clothes may retain more lint.</li> </ul>
	Incorrect sorting	<ul style="list-style-type: none"> <li>Separate lint producers from lint collectors.</li> </ul>
	Washing too long	<ul style="list-style-type: none"> <li>Wash small loads for a shorter time than larger loads.</li> </ul>
	Detergent not dissolving	<ul style="list-style-type: none"> <li>Add detergent as wash basket fills with water before you load clothes.</li> <li>Try a liquid detergent.</li> <li>Use warmer water temperature.</li> </ul>
	Overloading	<ul style="list-style-type: none"> <li>Load clothes no higher than the top row of holes in the washer basket.</li> <li>Make sure load size selected matches clothes load size.</li> </ul>
	Incorrect use of fabric softener	<ul style="list-style-type: none"> <li>Check fabric softener package for instructions and follow directions for using dispenser.</li> </ul>

## Before you call for service...

<b>PERFORMANCE (cont.)</b>	<b>Possible Causes</b>	<b>What To Do</b>
<b>Pilling</b>	Result of normal wear on poly-cotton blends and fuzzy fabrics	<ul style="list-style-type: none"> <li>• While this is not caused by the washer, you can slow the pilling process by washing garments inside out.</li> </ul>
<b>Snags, holes, tears, rips or excessive wear</b>	Pins, snaps, hooks, sharp buttons, belt buckles, zippers and sharp objects left in pockets	<ul style="list-style-type: none"> <li>• Fasten snaps, hooks, buttons and zippers.</li> <li>• Remove loose items like pins, objects in pockets and sharp buttons.</li> <li>• Turn knits (which snag easily) inside out.</li> </ul>
	Undiluted chlorine bleach	<ul style="list-style-type: none"> <li>• Check bleach package instructions for proper amount.</li> <li>• Never add undiluted bleach to wash or allow clothes to come in contact with undiluted bleach.</li> </ul>
	Chemicals like hair bleach or dye, permanent wave solution	<ul style="list-style-type: none"> <li>• Rinse items that may have chemicals on them before washing.</li> </ul>
<b>Wrinkling</b>	Improper sorting	<ul style="list-style-type: none"> <li>• Avoid mixing heavy items (like work clothes) with light items (like blouses).</li> <li>• Try a fabric softener.</li> </ul>
	Overloading or incorrect water level	<ul style="list-style-type: none"> <li>• Load your washer so clothes have enough room to move freely with water covering all of the clothes.</li> </ul>
	Incorrect wash and dry cycles	<ul style="list-style-type: none"> <li>• Match Cycle selection to the type of fabric you are washing (especially for easy care loads).</li> </ul>
	Repeated washing in water that is too hot	<ul style="list-style-type: none"> <li>• Wash in warm or cold water.</li> </ul>

<b>NOISE</b>	<b>Possible Causes</b>	<b>What To Do</b>
<b>Washer is noisy</b>	Washer is uneven	<ul style="list-style-type: none"> <li>• To level the front of the washer, adjust the front leveling legs by rotating the individual leg in the proper direction for up or down. To level back of washer, lift back of machine 4" (11 cm) and set down.</li> </ul>
	Washer load is unbalanced	<ul style="list-style-type: none"> <li>• Push the Cycle knob in to stop the washer, open the lid and redistribute the load evenly. Close the lid and restart.</li> </ul>
	Shipping rod is still assembled in unit	<ul style="list-style-type: none"> <li>• To remove shipping rod from washer, pull yellow tag and attached rod from the bottom right hand side of washer.</li> </ul>
	Washer is sitting too close to wall (causes knocking during cycle)	<ul style="list-style-type: none"> <li>• Pull washer away from the wall; about 4" (11 cm) is needed.</li> </ul>

<b>OTHER</b>	<b>Possible Causes</b>	<b>What To Do</b>
<b>Labels on the exterior of the washer will not peel off cleanly</b>	Occasionally the adhesive used on the labels does not release cleanly	<ul style="list-style-type: none"> <li>• Use a hair dryer set at the lowest heat setting, directing the air at the label for a short amount of time. This will release the adhesive easily, without damaging the surface of the washer.</li> </ul>

## GE Service Protection Plus™

GE, a name recognized worldwide for quality and dependability, offers you Service Protection Plus™—comprehensive protection on all your appliances—**No Matter What Brand!**

**Benefits Include:**

- Backed by GE
- All brands covered
- Unlimited service calls
- All parts and labor costs included
- No out-of-pocket expenses
- No hidden deductibles
- One 800 number to call

***We'll Cover Any Appliance.  
Anywhere. Anytime.\****

You will be completely satisfied with our service protection or you may request your money back on the remaining value of your contract. No questions asked. It's that simple.

Protect your refrigerator, dishwasher, washer and dryer, range, TV, VCR and much more—**any brand!** Plus there's no extra charge for emergency service and low monthly financing is available. Even icemaker coverage and food spoilage protection is offered. You can rest easy, knowing that all your valuable household products are protected against expensive repairs.

Place your confidence in GE and call us in the U.S. toll-free at **800.626.2224** for more information.

\*All brands covered, up to 20 years old, in the continental U.S.



Please place in envelope and mail to:

***General Electric Company***  
**Warranty Registration Department**  
**P.O. Box 32150**  
**Louisville, KY 40232-2150**



# Hotpoint Washer Warranty.



All warranty service provided by our Factory Service Centers, or an authorized Customer Care® technician. To schedule service, on-line, 24 hours a day, visit us at [www.Hotpoint.com](http://www.Hotpoint.com), or call **800.GE.CARES** (800.432.2737). Please have serial number and model number available when calling for service.

Staple your receipt here.  
Proof of the original purchase date is needed to obtain service under the warranty.

## For The Period Of: We Will Replace:

### One Year

From the date of the original purchase

**Any part** of the washer which fails due to a defect in materials or workmanship. During this **limited one-year warranty**, we will also provide, **free of charge**, all labor and related service costs to replace the defective part.

## What Is Not Covered:

- Service trips to your home to teach you how to use the product.
- Improper installation, delivery or maintenance.
- Failure of the product if it is abused, misused, or used for other than the intended purpose or used commercially.
- Replacement of house fuses or resetting of circuit breakers.
- Damage to the product caused by accident, fire, floods or acts of God.
- Incidental or consequential damage caused by possible defects with this appliance.
- Damage caused after delivery.
- Product not accessible to provide required service.

**EXCLUSION OF IMPLIED WARRANTIES—Your sole and exclusive remedy is product repair as provided in this Limited Warranty. Any implied warranties, including the implied warranties of merchantability or fitness for a particular purpose, are limited to one year or the shortest period allowed by law.**

This warranty is extended to the original purchaser and any succeeding owner for products purchased for home use within the USA. If the product is located in an area where service by a GE Authorized Servicer is not available, you may be responsible for a trip charge or you may be required to bring the product to an Authorized GE Service location. In Alaska, the warranty excludes the cost of shipping or service calls to your home.

Some states do not allow the exclusion or limitation of incidental or consequential damages. This warranty gives you specific legal rights, and you may also have other rights which vary from state to state. To know what your legal rights are, consult your local or state consumer affairs office or your state's Attorney General.

**Warrantor: General Electric Company, Louisville, KY 40225**

## Consumer Support.

---



### Hotpoint Website

[www.Hotpoint.com](http://www.Hotpoint.com)

Have a question or need assistance with your appliance? Try the Hotpoint Website 24 hours a day, any day of the year! You can also shop for more great Hotpoint products and take advantage of all of our on-line support services designed for your convenience.



### Schedule Service

[www.Hotpoint.com](http://www.Hotpoint.com)

Expert Hotpoint repair service is only one step away from your door. Get on-line and schedule your service at your convenience 24 hours any day of the year! Or call 800.GE.CARES (800.432.2737) during normal business hours.



### Real Life Design Studio

[ge.com](http://ge.com)

GE supports the Universal Design concept—products, services and environments that can be used by people of all ages, sizes and capabilities. We recognize the need to design for a wide range of physical and mental abilities and impairments. For details of GE's Universal Design applications, including kitchen design ideas for people with disabilities, check out our Website today. For the hearing impaired, please call 800.TDD.GEAC (800.833.4322).



### Extended Warranties

[ge.com](http://ge.com)

Purchase a Hotpoint extended warranty and learn about special discounts that are available while your warranty is still in effect. You can purchase it on-line anytime, or call 800.626.2224 during normal business hours. Hotpoint Consumer Home Services will still be there after your warranty expires.



### Parts and Accessories

[www.Hotpoint.com](http://www.Hotpoint.com)

Individuals qualified to service their own appliances can have parts or accessories sent directly to their homes (VISA, MasterCard and Discover cards are accepted). Order on-line today, 24 hours every day or by phone at 800.626.2002 during normal business hours.

**Instructions contained in this manual cover procedures to be performed by any user. Other servicing generally should be referred to qualified service personnel. Caution must be exercised, since improper servicing may cause unsafe operation.**



### Contact Us

[www.Hotpoint.com](http://www.Hotpoint.com)

If you are not satisfied with the service you receive from Hotpoint, contact us on our Website with all the details including your phone number, or write to: General Manager, Customer Relations  
Hotpoint, Appliance Park  
Louisville, KY 40225



### Register Your Appliance

[www.Hotpoint.com](http://www.Hotpoint.com)

Register your new appliance on-line—at your convenience! Timely product registration will allow for enhanced communication and prompt service under the terms of your warranty, should the need arise. You may also mail in the pre-printed registration card included in the packing material.