

This Owner's Manual is provided and hosted by [Appliance Factory Parts](http://ApplianceFactoryParts.com).

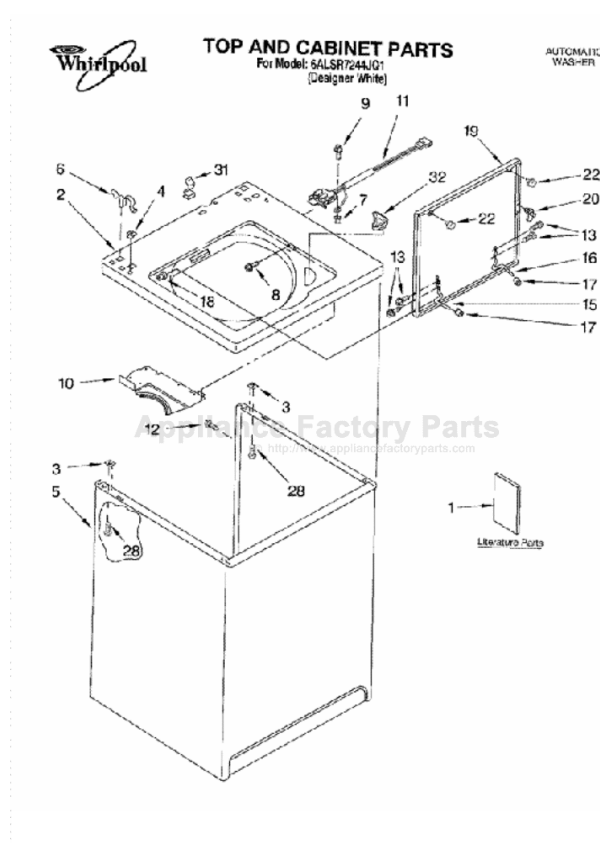

WHIRLPOOL 6ALSR7244JQ1 Owner's Manual

[Shop genuine replacement parts for WHIRLPOOL
6ALSR7244JQ1](#)



[Find Your WHIRLPOOL Washer Parts - Select From 4132 Models](#)

----- Manual continues below -----



TWO SPEED AUTOMATIC WASHER

Use & Care Guide

For questions about features, operation/performance, parts, accessories or service, call:

1-300-363-344 (Australia)

0-800-442-584 (New Zealand)

Table of Contents.....2

TABLE OF CONTENTS

WASHER SAFETY	3
PARTS AND FEATURES	4
WASHER USE	5
Understanding Washer Cycles	5
Loading	5
Normal Sounds	5
Starting Your Washer	6
Selecting a Cycle and Time	7
Stain Removal Tips	8
Extra Rinse and Spin	8
Drain and Spin	8
Adding Liquid Bleach	8
Adding Liquid Fabric Softener	8
WASHER CARE	9
Cleaning Your Washer	9
Water Inlet Hoses	9
Vacation, Storage, and Moving Care	9
TROUBLESHOOTING	9
ASSISTANCE OR SERVICE	11
WARRANTY	12

WASHER SAFETY

Your safety and the safety of others are very important.

We have provided many important safety messages in this manual and on your appliance. Always read and obey all safety messages.



This is the safety alert symbol.

This symbol alerts you to potential hazards that can kill or hurt you and others.

All safety messages will follow the safety alert symbol and either the word "DANGER" or "WARNING." These words mean:

⚠ DANGER

You can be killed or seriously injured if you don't immediately follow instructions.

⚠ WARNING

You can be killed or seriously injured if you don't follow instructions.

All safety messages will tell you what the potential hazard is, tell you how to reduce the chance of injury, and tell you what can happen if the instructions are not followed.

IMPORTANT SAFETY INSTRUCTIONS

WARNING: To reduce the risk of fire, electric shock, or injury to persons when using the washer, follow basic precautions, including the following:

- Read all instructions before using the washer.
- Do not wash articles that have been previously cleaned in, washed in, soaked in, or spotted with petrol, dry-cleaning solvents, other flammable, or explosive substances as they give off vapours that could ignite or explode.
- Do not add petrol, dry-cleaning solvents, or other flammable, or explosive substances to the wash water. These substances give off vapours that could ignite or explode.
- Under certain conditions, hydrogen gas may be produced in a hot water system that has not been used for 2 weeks or more. **HYDROGEN GAS IS EXPLOSIVE.** If the hot water system has not been used for such a period, before using the washing machine, turn on all hot water taps and let the water flow from each for several minutes. This will release any accumulated hydrogen gas. As the gas is flammable, do not smoke or use an open flame during this time.
- Do not allow children to play on or in the washer. Close supervision of children is necessary when the washer is used near children.
- Before the washer is removed from service or discarded, remove the door or lid.
- Do not reach into the washer if the drum, tub or agitator is moving.
- Do not install or store the washer where it will be exposed to the weather.
- Do not tamper with controls.
- Do not repair or replace any part of the washer or attempt any servicing unless specifically recommended in this Use and Care Guide or in published user-repair instructions that you understand and have the skills to carry out.
- See Installation Instructions for grounding requirements.
- If the supply cord is damaged, it must be replaced by the manufacturer or its service agent or a similarly qualified person in order to avoid a hazard.

SAVE THESE INSTRUCTIONS

PARTS AND FEATURES

This manual covers several different models. The washer you have purchased may have some or all of the parts and features listed below.

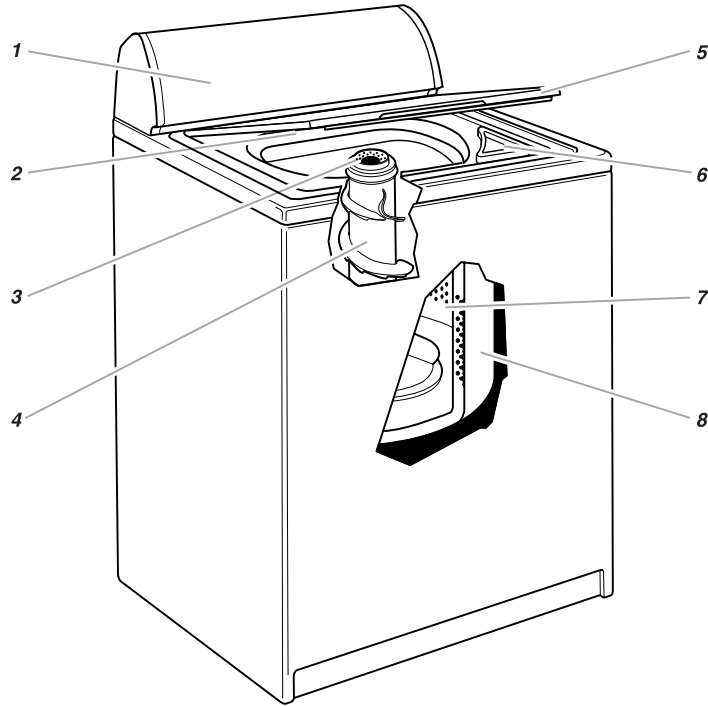

1. Control panel
2. Model and serial number label
3. Liquid fabric softener dispenser*
4. Agitator
5. Lid
6. Liquid bleach dispenser*
7. Basket
8. Tub

Other features your washer may have

- CLEAN TOUCH control panel
- DURASMOOTH white porcelain basket
- Extra rinse selector
- Cycle signal selector

*On some models

Control panel



WASHER USE

Understanding Washer Cycles





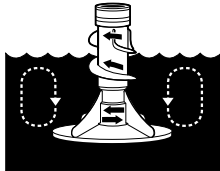





When the Cycle Control knob is set to a number and pulled out, the washer fills (to the selected load size) before agitation and timing start. The washer begins agitating immediately after filling; agitation occurs with the washer lid up or down.

During agitation, the agitator creates a continuous rollover action (on some models) that provides a thorough cleaning of the wash load.



After agitation starts, the Cycle Control knob turns clockwise until it points to an OFF area and the cycle ends.

NOTE: The washer pauses briefly throughout each cycle. These pauses are normal for washer operation.

WASH	RINSE
 <p>1. Fill</p>	 <p>1. Fill</p>
 <p>2. Wash selected time</p>	 <p>2. Rinse</p>
 <p>3. Drain[†] No agitation</p>	 <p>3. Drain No agitation</p>
 <p>4. Spin</p>	 <p>4. Spin-Spray rinse</p>
	 <p>5. Spin</p>
<p>[†] The Casual cycle partially drains, fills, agitates briefly, and drains.</p>	 <p>6. Off</p>

Loading

Loading suggestions

For these suggested full-sized loads, set the LOAD SIZE selector to the highest setting.

SUPER CAPACITY PLUS WASHERS

Heavy Work Clothes

3 pair pants	1 coverall
3 shirts	1 overall
4 pair jeans	

Delicates

3 camisoles	6 undergarments
1 quilted robe	2 sets of sleepwear
4 slips	1 child's outfit

Towels

10 bath towels	14 wash cloths
10 hand towels	1 bath mat

Mixed Load

3 double sheets	2 shirts
4 pillowcases	2 blouses
8 T-shirts	8 handkerchiefs
6 pair shorts	

Normal Sounds

Your new washer may make sounds your old one didn't. Because the sounds might be unfamiliar, you may be concerned about them. These sounds are normal.

During washing

When you select a small load size setting, your washer has a lower water level. This can cause a clicking sound from the upper part of the agitator.

During drain

If water is drained quickly from your washer (depending on your installation), you may hear air being pulled through the pump during the end of draining.

After drain and before spin

When the cycle changes from draining to spinning, you may hear gears engaging.

Starting Your Washer

⚠ WARNING



Fire Hazard

Never place items in the washer that are dampened with petrol or other flammable fluids.

No washer can completely remove oil.

Do not dry anything that has ever had any type of oil on it (including cooking oils).

Doing so can result in death, explosion, or fire.

⚠ WARNING



Electrical Shock Hazard

Plug into an earthed plug socket outlet.

Do not remove earth pin.

Do not use an adaptor.

Do not use an extension cord.

Failure to follow these instructions can result in death, fire, or electrical shock.

1. Measure detergent and pour it into the washer. If desired, add powdered or liquid colour safe bleach. If the water temperature is too low, dilute the detergent in warm water. Add extra detergent for the Super Wash cycle. Follow detergent manufacturer's directions.

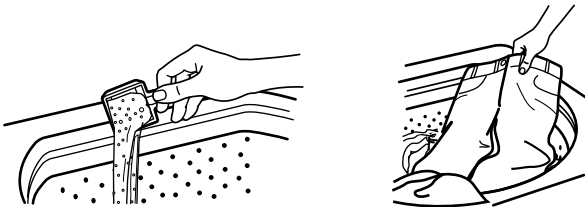

Drop a sorted load of clothes loosely into your washer.

- Load evenly to maintain washer balance. Mix large and small items. Larger items such as sheets should be added last.
- Items should move easily through the wash water. Overloading can cause poor cleaning.

- To reduce wrinkling of permanent press clothes and some synthetic knits, use a large load size to provide more space (see step 5).
2. (OPTIONAL STEP) Pour measured liquid bleach into the liquid bleach dispenser (on some models). Bleach will be dispensed automatically during the wash part of the cycle.

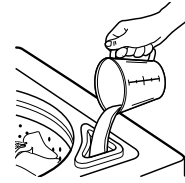

- Never use more than 250 mL (1 cup) for a full load. Use less with a smaller load size.
- Follow the manufacturer's directions for safe use.
- To avoid spilling, use a cup with a pouring spout. Do not let bleach splash, drip, or run down into the washer basket.
- Use only liquid bleach in this dispenser.

NOTE: On models without a liquid bleach dispenser, see "Adding Liquid Bleach."

3. (OPTIONAL STEP) Pour measured liquid fabric softener into the liquid fabric softener dispenser (on some models). Softener is added automatically during the rinse portion of the cycle.

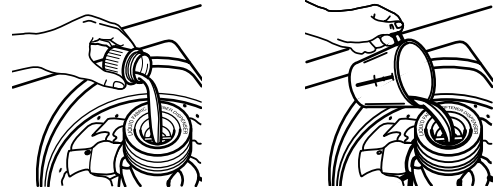

Dilute liquid fabric softener by filling the dispenser with warm water until liquid reaches the crossbar in the opening.

- Do not spill or drip any fabric softener on the clothes.
- Use only liquid fabric softener in this dispenser.

NOTE: On models without a fabric softener dispenser, see "Adding Liquid Fabric Softener."

4. Close the washer lid.
5. Turn the LOAD SIZE selector to the correct setting for your wash load and the type of fabric being washed.
 - Choose a load size that allows the load to move freely for best fabric care. See "Loading."
 - You may change the load size selection after the washer has started filling by turning the selector to a different setting. If your washer has a RESET option, first move the selector to RESET, then to the new water level.

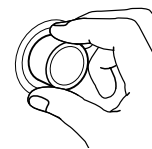

- Set the TEMPERATURE selector to the correct setting for the type of fabric and soils being washed. Use the warmest water safe for fabric. Follow garment label instructions.

Your washer uses automatic temperature control to maintain a uniform water temperature by regulating incoming hot and cold water. This helps eliminate undissolved detergent and ensures consistent cleaning results. The cold wash is regulated at approximately 24°C (75°F) by adding small amounts of hot water during the cold fill. The warm wash is maintained at approximately 38°C (100°F).

NOTE: Make sure that both hot and cold water taps are fully turned on or the automatic temperature control feature will not work properly.

Water Temp	Use For
Hot 44°C (111°F) or above	Whites and pastels Heavy soils
Warm 32°-43°C (90°-110°F)	Bright colours Moderate to light soils
Cold 21°-32°C (70°-90°F)	Colours that bleed or fade Light soils

NOTE: In wash water temperatures colder than 21°C (70°F), detergents do not dissolve well. Soils can be difficult to remove. Some fabrics can retain wear wrinkles and have increased pilling (the formation of small lint-like balls on the surface of garments).

- (OPTIONAL STEP) Some models have an EXTRA RINSE selector. For an additional rinse and spin at the end of a wash cycle, set the EXTRA RINSE selector to ON. On some models, the Extra Rinse feature is part of the cycle (see “Extra Rinse and Spin”).
- (OPTIONAL STEP) Some models have a CYCLE SIGNAL selector. Set the CYCLE SIGNAL selector to ON if you want your washer to alert you when the wash cycle is complete. The signal is helpful when you are washing items that should be removed from the washer as soon as the cycle ends.
- Push in the Cycle Control knob and turn it clockwise to the wash cycle you want. Reduce the wash time when using a small load size setting. See “Selecting a Cycle and Time.”



Pull out the Cycle Control knob to start the washer.

To stop or restart your washer

- To stop the washer at any time, push in the Cycle Control knob. Do NOT stop the washer while it’s pumping out the water.
- To restart the washer, close the lid (if open) and pull out the Cycle Control knob.

Selecting a Cycle and Time

This section describes the available wash cycles and will help you make the best cycle selections for your wash loads. Each cycle is designed for different types of fabric and soil levels.

NOTE: When tested to AS2040-1990 for wash performance, the Regular/Normal cycle was selected with extra large load size, warm wash, and cold rinse.

- The washer pauses briefly throughout each cycle. These pauses are normal. Refer to “Normal Sounds” to learn more about the sounds you may hear during a wash cycle.
- Refer to “Understanding Washer Cycles” to learn what happens during a wash cycle.

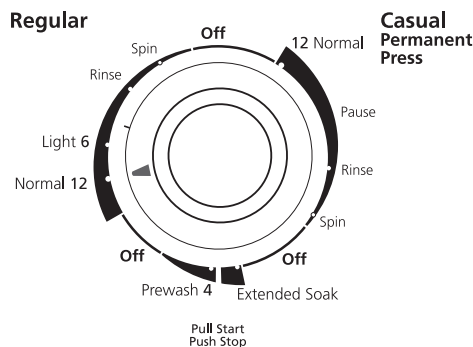

NOTE: This manual covers several different models. The washer you purchased may vary from the model shown and will not have all of the cycles described.

Regular cycle

This cycle starts with high-speed agitation and then steps to low-speed agitation for cleaning cottons and linens. High spin speeds shorten drying times. Select up to 12 minutes of wash time (depending on your model) for cleaning lightly, moderately or heavily soiled loads. For lightly soiled loads, use the shortest time setting.

Super Wash - Use this setting for washing heavily soiled loads that need maximum soil removal. Follow detergent manufacturer’s directions for heavily soiled clothing. The Super Wash setting automatically prewashes the laundry and advances into the Normal cycle.

Casual/Permanent Press cycle

This cycle starts with high-speed agitation and then steps to low-speed agitation for cleaning permanent press and synthetic fabrics that are lightly or moderately soiled. To reduce wrinkling, this cycle features a cool-down phase at the end of the wash followed by a low-speed spin. After the rinse, the cycle ends with a short high-speed spin for maximum water removal. Use the 4-minute Light or Delicate setting (depending on your model) for cleaning delicate items and washable knits that are lightly or moderately soiled.

Hand Washables cycle

This cycle features a series of brief, low-speed agitations and short soaks to gently clean special care items. Low spin speeds minimize wrinkling. Use this cycle for cleaning lightly soiled hand washables.

Woolens - Use this setting for washable woollens and knits that are lightly soiled. For best results, select cold wash and rinse when using this setting. Please note that the automatic temperature control feature on this washer will blend cold and warm water to give a wash water temperature of approximately 24°C (75°F).

Garments are labeled "Hand Wash" because:

- The fiber or construction may be sensitive to agitation.
- The fabric contains sensitive dyes that may bleed.

NOTE: Some "Hand Wash" items, particularly wool, naturally shrink when washed. Keep this in mind when you purchase items labeled "Hand Wash."

Properly sort and then use your Hand Washables cycle for gentle washing. If items appear to be floating due to trapped air, stop the washer by pushing in the Cycle Control knob. Push items down into the water. Restart the washer by pulling out the Cycle Control knob. Follow care label directions for drying. Items that may shrink should be dried flat. When still wet, block these items by gently stretching to original measurements.

Extended Soak cycle

The Soak cycle features a brief period of agitation and soak time to remove heavy soils and stains that need pretreatment. The soak period will continue as long as you like. Thirty minutes or less is recommended for most loads.

- Use warm water when soaking laundry. Hot water can set stains.
- Use the amount of detergent and presoak additive recommended by the manufacturer.
- When you have decided to end the Soak cycle, turn the Cycle Control knob to Prewash or Spin (to drain the water).
- Add detergent and select a new wash cycle.

Prewash cycle

This cycle features a brief period of high-speed agitation to help remove heavy soils and stains that need pretreatment. Use warm water for prewashing stained laundry. Hot water can set stains. After the Prewash cycle ends, add detergent and select a new wash cycle.

Stain Removal Tips

Stained or heavily soiled items may need to be prewashed or soaked for best results. Soaking helps remove protein-type stains such as blood, milk, or grass. Prewashing helps loosen soil before washing.

- Use cold or warm water for soaking or prewashing stained laundry. Hot water can set stains.
- Most stains are easier to remove when they are fresh. Old or set stains may not come out. Follow package directions for pretreatment products.
- Before treating any stain, find out what kind of stain it is, how old the stain is, what kind of fabric it is, and if the fabric is colourfast. (Check the care label.)
- When bleach is recommended, use a bleach that is safe for the fabric.
- Test stain removers on an inside seam or hidden corner of the item to see if the colour is removed.
- Put the stained area face down on a paper towel or white cloth. Apply the stain remover to the back of the stain. This forces the stain off the fabric instead of through it.
- Meat tenderizer or enzyme presoaks help break down some protein stains so they are easier to remove.
- Washing and drying can set some stains.

Extra Rinse and Spin

When using extra detergent for heavily soiled clothes, or washing special-care items, you may find an extra rinse and spin is needed.

1. Push in the Cycle Control knob and turn it clockwise to any of the Rinse settings.
2. Pull out the Cycle Control knob. The washer fills to the selected load size, agitates, drains, and spins.

NOTE: An EXTRA RINSE option is available (on some models). See "Starting Your Washer."

Drain and Spin

A drain and spin may help shorten drying times for some heavy fabrics or special-care items by removing excess water.

1. Push in the Cycle Control knob and turn it clockwise to any of the Spin settings.
2. Pull out the Cycle Control knob. The washer drains, then spins.

Adding Liquid Bleach

Always measure liquid bleach. Do not guess. Never use more than 250 mL (1 cup) for a full load. Follow manufacturer's directions for safe use. Use a cup with a pouring spout to avoid spilling.

1. Let the washer fill and begin agitating the load.
2. Add bleach to the wash cycle so it can be removed in the rinse cycle. Pour bleach around the agitator, not directly on the load.
 - Follow directions on the care labels. Do not use liquid bleach on wool, silk, spandex, acetates, or some flame-retardant fabrics.
 - When soaking with liquid bleach, add detergent to soak water.

NOTE: Undiluted bleach will damage any fabric it touches. The damage appears as rips, holes, tears, or colour loss and may not show up until several washings later.

Adding Liquid Fabric Softener

Always dilute fabric softener with 125 to 250 mL (½ to 1 cup) warm water. Undiluted fabric softener can stain fabrics.

- Add diluted fabric softener only in the final rinse.
- Fabric softener should not be mixed with other laundry products. Greasy stains can form. To remove greasy stains, wet the stain and rub with liquid detergent or a bar of soap. Rewash.
- Too much fabric softener can make some items (diapers and towels) nonabsorbent. If this happens, use less fabric softener, or do not use it every time.

WASHER CARE

Cleaning Your Washer

Cleaning the exterior

Use a soft, damp cloth or sponge to wipe up any spills such as detergent or bleach. Occasionally wipe the outside of your washer to keep it looking new.

Cleaning the interior

Clean your washer interior by mixing 250 mL (1 cup) of liquid bleach and 500 mL (2 cups) of detergent. Pour this into your washer and run it through a complete cycle using hot water. Repeat this process if necessary.

NOTE: Remove any hard water deposits using only cleaners labeled as washer safe.

Cleaning the liquid fabric softener dispenser

Flush dispenser periodically with warm water, as shown. Remove the dispenser by grasping the top of the dispenser with both hands and squeezing and pushing upward with thumbs. Clean the dispenser by rinsing it under a water tap. Replace it after cleaning.

NOTE: Do not wash clothes with this dispenser removed. Do not add detergent or bleach to this dispenser; it is for liquid fabric softener use only.

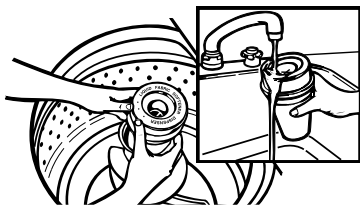

Water Inlet Hoses

Replace inlet hoses after five years of use to reduce the risk of hose failure. Periodically inspect and replace inlet hoses if bulges, kinks, cuts, wear, or leaks are found.

The appliance is to be connected to the water mains using the new hose-sets supplied and that old hose-sets should not be re-used.

When replacing your inlet hoses, mark the date of replacement on the label with a permanent marker.

Vacation, Storage, and Moving Care

Install and store your washer where it will not freeze. Because some water may stay in the hoses, freezing can damage your washer. If storing or moving your washer during freezing weather, winterize it.

Non-use or vacation care

Operate your washer only when you are at home. If you will be on vacation or not using your washer for an extended period of time, you should:

- Unplug washer or disconnect power.
- Turn off the water supply to the washer. This helps avoid accidental flooding (due to a water pressure surge) while you are away.

To winterize washer

1. Shut off both water taps.
2. Disconnect and drain water inlet hoses.
3. Put 1 L (quart) of R.V.-type antifreeze in the basket.
4. Run washer on a drain and spin setting (see “Drain and Spin”) for about 30 seconds to mix the antifreeze and water.
5. Unplug washer or disconnect power.

To use washer again

1. Flush water pipes and hoses.
2. Reconnect water inlet hoses.
3. Turn on both water taps.
4. Plug in washer or reconnect power.
5. Run the washer through a complete cycle with 250 mL (1 cup) of detergent to clean out antifreeze.

TROUBLESHOOTING

First try the solutions suggested here and possibly avoid the cost of a service call...

Washer won't fill, rinse or agitate or wrong temperature

- **Check the following:**
 - Is the power cord plugged into an earthed plug socket outlet?
 - Is the indicator on the Cycle Control knob properly lined up with a cycle? Turn the Cycle Control knob to the right slightly and pull to start.
 - Are the water inlet valve screens clogged?
 - Are both the hot and cold water taps turned on?
 - Is the water inlet hose kinked?
- **Does the water level seem too low, or does the washer appear to not fill completely?**

The top of the agitator is much higher than the highest water level. This creates a perception that the washer is not filling completely. This is normal.

Washer stops

- **Check the following:**
 - Is the power cord plugged into an earthed plug socket outlet?
 - Is the indicator on the Cycle Control knob properly lined up with a cycle? Turn the Cycle Control knob to the right slightly and pull to start.
 - Are the water inlet valve screens clogged?
 - Are both the hot and cold water taps turned on?
 - Is the water inlet hose kinked?
- **Is there power at the plug?**

Check your electrical source or call an electrician.
- **Has a fuse blown or is the circuit breaker open?**

If problem continues, call an electrician.

- **Are you using an extension cord?**
Do not use an extension cord.
- **Is the washer in a normal pause in the Casual/Permanent Press (or Hand Washables) cycle?**
The washer pauses for about 2 minutes in the Casual/Permanent Press cycle. Allow the cycle to continue.
The Hand Washables cycle (on some models) features periods of agitation and soak.
- **Is the washer overloaded?**
Wash smaller loads.

Washer won't drain or spin

- **Is the drain hose clogged, or the end of the drain hose more than 244 cm (96 in.) above the floor?**
See the Installation Instructions for proper installation of drain hose.
- **Is the lid open?**
The lid must be closed during operation.
- **Is there excessive sudsing?**
Always measure detergent. Follow manufacturer's directions. If you have very soft water, you might need to use less detergent.
- **Is your voltage low?**
Check your electrical source or call an electrician. Do not use an extension cord.

Washer continues to fill or drain, or the cycle seems stuck

- **Is the top of drain hose lower than the water level in washer?**
The top of the hose must be higher than the water level in the washer for proper operation. See the Installation Instructions.
- **Does the drain hose fit too tightly in the standpipe, or is it taped to the standpipe?**
The drain hose should be loose yet fit securely. Do not seal the drain hose with tape. The hose needs an air gap. See the Installation Instructions.

Washer makes noise

- **Is the load balanced and the washer level?**
The wash load should be balanced and not overloaded.
The washer must be level. The front feet should be properly installed and the nuts tightened. Reset the rear leveling legs (if needed). See the Installation Instructions.
- **Did you completely remove the yellow shipping strap with cotter pins?**
See the Installation Instructions.
- **Are the gears engaging after the drain and before spin, or is the upper part of agitator clicking during wash?**
These are normal washer noises.

Washer leaks

- **Check the following:**
Are the fill hoses tight? Are the fill hose washers properly seated? Is the drain hose clamp properly installed? See the Installation Instructions.
- **Is the sink or drain clogged?**
Sink and standpipe must be able to handle 64 L (17 gal.) of water per minute.

- **Is water deflecting off the tub ring or the load?**
Center the tub before starting the washer.
The wash load should be balanced and not overloaded. The fill or spray rinses can deflect off the load.
The washer must be level. The front feet should be properly installed and the nuts tightened. Reset the rear leveling legs (if needed). See the Installation Instructions.
- **Check household plumbing for leaks.**

Washer basket is crooked

- **Was the washer basket pulled forward during loading?**
The wash load should be balanced and not overloaded. Push the basket to the center before starting wash.
- **Is the load balanced and the washer level?**
The wash load should be balanced and not overloaded.
The washer must be level. The front feet should be properly installed and the nuts tightened. Reset the rear leveling legs (if needed). See the Installation Instructions.
- **The washer basket moves while washing.**
This is normal.

Agitator operation

- **The top of the agitator is loose, or moves in only one direction.**
This is normal.

Dispensers clogged or bleach leaking

- **Did you follow the manufacturer's directions when adding detergent and fabric softener to the dispensers?**
Measure detergent and fabric softener. Carefully pour into the dispensers. Wipe up all spills.
Dilute fabric softener in the fabric softener dispenser.
- **Did you put powdered or colour-safe bleach in the liquid bleach dispenser?**
Add powdered or liquid colour-safe bleach directly to the basket. Do not use the bleach dispenser for colour-safe bleach.

Load too wet

- **Did you use the right cycle for the load being washed?**
Select a cycle with a higher spin speed (if available).
- **Did you use a cold rinse?**
Cold rinses leave loads wetter than warm rinses. This is normal.

Residue or lint on load

- **Did you sort properly?**
Sort lint givers (towels, chenille) from lint takers (corduroy, synthetics). Also sort by colour.
- **Did you overload the washer?**
The wash load must be balanced and not overloaded. Lint can be trapped in the load if overloaded. Wash smaller loads.
- **Check the following:**
Was paper or tissue left in the pockets?
Did you use enough detergent? Follow manufacturer's directions. Use enough detergent to hold the lint in the water.
Is your water colder than 21°C (70°F)? Wash water colder than 21°C (70°F) may not completely dissolve the detergent.

Stains on load

- **Did you follow the manufacturer's directions when adding detergent and fabric softener?**
Measure detergent and fabric softener. Use enough detergent to remove soil and hold it in suspension.

Dilute fabric softener and add to the rinse portion of a cycle only. Do not drip fabric softener on clothes.
- **Is there above average iron (rust) in water?**
You may need to install an iron filter.
- **Did you properly sort the load?**
Sort dark clothes from whites and lights.
- **Did you unload the washer promptly?**
To avoid dye transfer, unload the washer as soon as it stops.

Load is wrinkled

- **Did you unload the washer promptly?**
Unload the washer as soon as it stops.
- **Did you use the right cycle for the load being washed?**
Use the Casual/Permanent Press cycle or a cycle with low spin speeds (if available) to reduce wrinkling.
- **Did you overload the washer?**
The wash load must be balanced and not overloaded. Loads should move freely during washing.
- **Was the wash water warm enough to relax wrinkles, or are you using warm rinses?**
If safe for the load, use warm or hot wash water. Use cold rinse water.
- **Are the hot and cold water hoses reversed?**
Check to be sure the hot and cold water hoses are connected to the right taps. See the Installation Instructions.

Load is tangled or twisted

- **Did you overload the washer?**
The wash load must be balanced and not overloaded. Loads should move freely during washing.
- **Did you wrap items around the agitator?**
Drop items loosely into the washer. Do not wrap items around the agitator.

Grey whites, dingy colours

- **Did you properly sort the load?**
Dye transfer can occur when mixing whites and colours in a load. Sort dark clothes from whites and lights.
- **Was the wash temperature too low?**
Use hot or warm washes if safe for the load. Hot water should be at least 44°C (111°F) to clean heavy soils.
- **Did you use enough detergent, or do you have hard water?**
Use more detergent for washing heavy soils in cold or hard water.
- **Are the hot and cold water hoses reversed?**
Check to be sure the hot and cold water hoses are connected to the right taps. See the Installation Instructions.

Garment damage

- **Check the following:**
Were sharp items removed from pockets before washing?
Empty pockets, zip zippers, snap or hook fasteners before washing.

Were strings and sashes tied to prevent tangling?

Were items damaged before washing? Mend rips and broken threads in seams before washing.
- **Did you overload the washer?**
The wash load must be balanced and not overloaded. Loads should move freely during washing.
- **Did you properly add liquid bleach?**
Do not pour liquid bleach directly on load. Wipe up bleach spills. Undiluted bleach will damage fabrics.
- **Did you follow the manufacturer's care label instructions?**

ASSISTANCE OR SERVICE

Before calling for assistance or service, please check "Troubleshooting." It may save you the cost of a service call. If you still need help, follow the instructions below.

When calling, please know the purchase date and the complete model and serial number of your appliance. This information will help Whirlpool to better respond to your request.

If you need replacement parts

If you need to order replacement parts, Whirlpool recommends that you only use factory specified parts. These parts will fit right and work right because they are made with the same precision used to build every new WHIRLPOOL® appliance. To locate replacement parts in your area, call the Customer Interaction Centre or your nearest Whirlpool designated service company.

Call the Whirlpool Customer Interaction Centre at 1-300-363-344 (Australia) or 0-800-442-584 (New Zealand). Our consultants provide assistance with:

- Features and specifications on our full line of appliances
- Installation information
- Use and maintenance procedures
- Accessory and repair parts sales
- Referrals to local dealers, repair parts distributors, and service companies

Whirlpool designated service technicians are trained to fulfill the product warranty and provide after-warranty service.

NOTE: If the power supply cord of this washer is damaged, it must be replaced by a special cord (Part Number 8316026) available from the dealer from whom you purchased the washer or a Whirlpool designated service company.

Gearcase assembly covered by your warranty

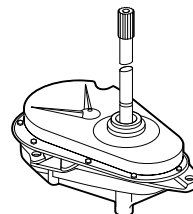

WHIRLPOOL® WASHER WARRANTY

TWO-YEAR FULL WARRANTY

For two years from the date of purchase, when this washer is used in domestic or single-family applications, and operated and maintained according to instructions attached to or furnished with the product, Whirlpool (Australia) Pty Limited will pay for replacement parts and repair labour to correct defects in materials or workmanship. Service must be provided by Whirlpool (Australia) Pty Limited or its appointed Service Claimants.

NINETY-DAY FULL WARRANTY

For ninety days from the date of purchase, when this washer is used in commercial, multi-family or personal applications, and operated and maintained according to instructions attached to or furnished with the product, Whirlpool (Australia) Pty Limited will pay for replacement parts and repair labour to correct defects in materials or workmanship. Service must be provided by Whirlpool (Australia) Pty Limited or its appointed Service Claimants.

THIRD THROUGH FIFTH YEAR LIMITED WARRANTY - ON TOP, LID AND GEARCASE ASSEMBLY

For the third through fifth year from the date of purchase, when this washer is operated and maintained according to instructions attached to or furnished with the product, Whirlpool (Australia) Pty Limited will pay for replacement parts for any top and lid rust, and any part of the gearcase assembly, if defective in materials or workmanship.

THIRD THROUGH TENTH YEAR LIMITED WARRANTY - ON OUTER TUB

For the third through tenth year from the date of purchase, when this washer is operated and maintained according to instructions attached to or furnished with the product, Whirlpool (Australia) Pty Limited will pay for replacement parts for the outer tub should it crack or fail to contain water, if defective in materials or workmanship.

Whirlpool (Australia) Pty Limited will not pay for:

1. Service calls to correct the installation of your washer, to instruct you how to use your washer, or to replace house fuses or correct house wiring or plumbing.
 2. Damage resulting from accident, alteration, misuse, abuse, fire, flood, acts of God, improper installation, installation not in accordance with local electrical and plumbing codes, or use of products not approved by Whirlpool (Australia) Pty Limited.
 3. Repairs which result from parts not having been fitted by an authorized Whirlpool person or entity, or from the use of the appliance in a manner other than the use for which it was specifically designed.
 4. Replacement parts or repair labour costs for units operated outside Australia or New Zealand.
 5. Repairs to parts or systems resulting from unauthorized modifications made to the appliance.
 6. Costs associated with service calls, freight or transport of goods requiring service from areas outside of those which are serviced by Whirlpool (Australia) Pty Limited or its appointed Service Claimants.
-

WHIRLPOOL (AUSTRALIA) PTY LIMITED SHALL NOT BE LIABLE FOR INCIDENTAL OR CONSEQUENTIAL DAMAGES.

The benefits conferred by this express warranty are additional to all other conditions, warranties, guaranties, rights and remedies expressed or implied by the Trade Practices Act, the New Zealand Sale of Goods Act and similar State or Territory laws and all other obligations and liabilities on the part of the manufacturer or supplier and nothing contained herein shall restrict or modify such rights, remedies, obligations or liabilities.

If you need service, first see "Troubleshooting." Additional help can be found by checking "Assistance or Service," or calling our Customer Interaction Centre at **1-300-363-344** (Australia) or **0-800-442-584** (New Zealand).

5/00

Keep this book and your sales slip together for future reference. You must provide proof of purchase or installation date for in-warranty service.

Write down the following information about your washer to better help you obtain assistance or service if you ever need it. You will need to know your complete model number and serial number. You can find this information on the model and serial number label/plate, located on your appliance as shown in "Parts and Features."

Dealer name _____
Model number _____
Serial number _____
Model number _____
Serial number _____
Purchase date _____

3951076A

© 2002 Whirlpool Corporation.
All rights reserved.

© Registered Trademark/TM Trademark of Whirlpool, U.S.A.



4/02
Printed in U.S.A.