

This Owner's Manual is provided and hosted by [Appliance Factory Parts](#).



Bissell 8940 Owner's Manual

[Shop genuine replacement parts for Bissell 8940](#)



[Find Your Bissell Vacuum Cleaner Parts - Select From 376 Models](#)

----- Manual continues below -----



PowerSteamer®

UPRIGHT DEEP CLEANER

USER'S GUIDE

1685 / 8940 SERIES

3

Safety Instructions

4

Product View

5

Assembly

5-7

Operations

7-8

Maintenance

9

Troubleshooting

10

Consumer Services

11

Replacement Parts

12

Warranty



Thanks for buying a BISSELL PowerSteamer

We're glad you purchased a BISSELL PowerSteamer Deep Cleaner. Everything we know about floor care went into the design and construction of this complete, high-tech home cleaning system.

Your PowerSteamer is well made, and we back it with a limited one-year warranty. We also stand behind it with a knowledgeable, dedicated Consumer Services Department, so, should you ever have a problem, you'll receive fast, considerate assistance.

My great-grandfather invented the floor sweeper in 1876. Today, BISSELL is a global leader in the design, manufacture, and service of high quality homecare products like your PowerSteamer.

Thanks again, from all of us at BISSELL.

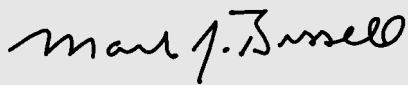

Mark J. Bissell
President and Chief Executive Officer

IMPORTANT SAFETY INSTRUCTIONS

When using an electrical appliance, basic precautions should be observed, including the following:

Read all instructions before using your POWERSTEAMER.

⚠ WARNING: To reduce the risk of fire, electric shock, or injury:

- Do not immerse.
- Use only on surfaces moistened by cleaning process.
- Always connect to a properly grounded outlet. See Grounding Instructions.
- Unplug from outlet when not in use and before conducting maintenance or troubleshooting.
- Do not leave machine when it is plugged in.
- Do not service machine when it is plugged in.
- Do not use with damaged cord or plug.
- If appliance is not working as it should, has been dropped, damaged, left outdoors, or dropped into water, have it repaired at an authorized Service Center.
- Use indoors only.
- Do not pull or carry by cord, use cord as a handle, close door on cord, pull cord around sharp corners or edges, run appliance over cord, or expose cord to heated surfaces.
- Do not carry the appliance while in use.
- Do not unplug by pulling on cord. Unplug by grasping the plug, not the cord.
- Do not handle plug or appliance with wet hands.
- Do not put any object into appliance openings, use with blocked opening, or restrict air flow.
- Do not expose hair, loose clothing, fingers or body parts to openings or moving parts.
- Do not pick up hot or burning objects.
- Do not pick up flammable or combustible materials (lighter fluid, gasoline, kerosene, etc.) or use in the presence of explosive liquids or vapor.
- Do not use appliance in an enclosed space filled with vapors given off by oil base paint, paint thinner, some moth proofing substances, flammable dust, or other explosive or toxic vapors.
- Do not pick up toxic material (chlorine bleach, ammonia, drain cleaner, gasoline, etc.).
- Do not modify the 3-prong grounded plug.
- Do not allow to be used as a toy.
- Do not use for any purpose other than described in this User's Guide.
- Do not operate the appliance unless the belt door is securely assembled in the location provided.

- Use only manufacturer's recommended attachments.
- Use only cleaning products formulated by BISSELL for use in this appliance.
- Keep openings free of dust, lint, hair, etc.
- Keep appliance on a level surface.
- Turn off all controls before unplugging.
- Be extra careful when cleaning stairs.
- Close attention is necessary when used by or near children.

WARNING: The power cord in this product contains lead, a chemical known to the State of California to cause birth defects or other reproductive harm. **Wash hands after handling.**

SAVE THESE INSTRUCTIONS.

THIS MODEL IS FOR HOUSEHOLD USE ONLY. Commercial use of this unit voids the manufacturer's warranty.

GROUNDING INSTRUCTIONS

This appliance must be connected to a grounded wiring system. If it should malfunction or break down, grounding provides a safe path of least resistance for electrical current, reducing the risk of electrical shock. The cord for this appliance has an equipment-grounding conductor and a grounding plug. It must only be plugged into an outlet that is properly installed and grounded in accordance with all local codes and ordinances.

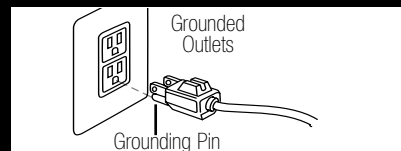

⚠ WARNING: Improper connection of the equipment-grounding conductor can result in a risk of electrical shock. Check with a qualified electrician or service person if you aren't sure if the outlet is properly grounded. **DO NOT MODIFY THE PLUG.** If it will not fit the outlet, have a proper outlet installed by a qualified electrician. This appliance is designed for use on a nominal 120-volt circuit, and has a grounding attachment plug that looks like the plug in the drawing above. Make certain that the appliance is connected to an outlet having the same configuration as the plug. No plug adapter should be used with this appliance.

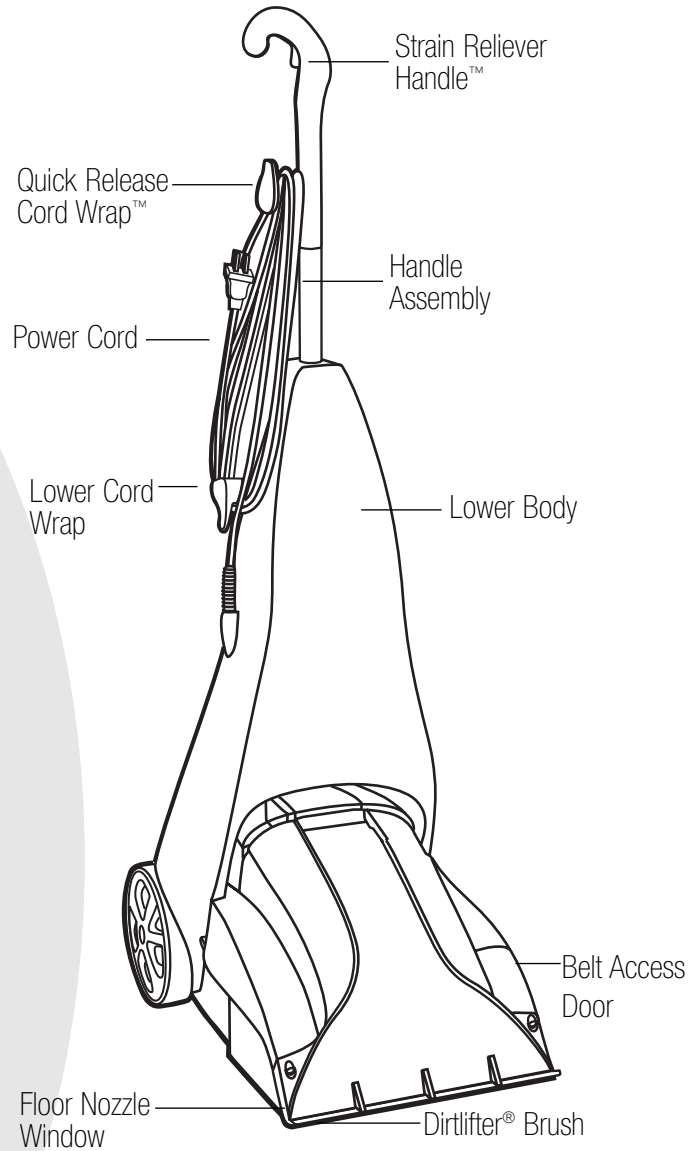
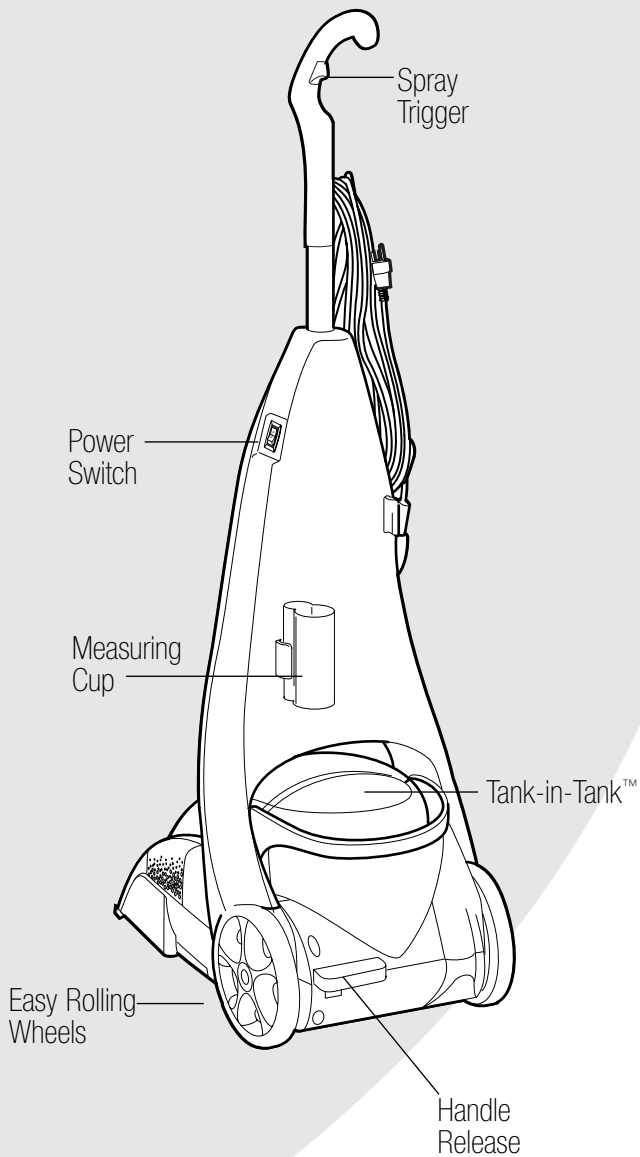

WARNING:

To reduce the risk of fire, use only BISSELL Deep Cleaning formulas in your PowerSteamer. Use of cleaning formulas that contain lemon or pine oil may damage this appliance and void warranty. Chemical spot cleaners or solvent-based soil removers should not be used. These products may react with the plastic materials used in your PowerSteamer causing cracking or pitting.

How To Use This Guide

Your PowerSteamer assembles in two quick steps. The only tool you will need to assemble your cleaner is a Phillips head  screwdriver.

Your PowerSteamer is packaged as two primary components... the Lower Body and the Handle Assembly. To assemble:

- 1.** Slide the Handle Assembly (with attached Quick Release Cord Wrap™) down into the Lower Body until it will go no further.
- 2.** Secure the handle by placing one (1) Phillips head  screw (supplied) through the screw opening in the Lower Body and into the rear of the Handle Assembly. Tighten with screwdriver until secure.

Assembly is now complete.

The Basics: How Your PowerSteamer Works

Power

The Power Switch controls power to the machine.

DirtLifter Brush

The brush at the Floor Nozzle is designed to enhance cleaning performance. The bristle pattern lifts out the deep down dirt while gently grooming carpet fibers. The floating suspension self-adjusts to all carpet heights.

Measuring Cup

Your PowerSteamer is equipped with a Measuring Cup for adding the proper amount of cleaning formula to the Tank-in-Tank. Before using the machine, simply fill the Measuring Cup to the fill line with BISSELL Fiber Cleansing Formula. Pour the formula into the Tank-in-Tank as shown on page 6. For convenience, the Measuring Cup stores on the back of the unit.

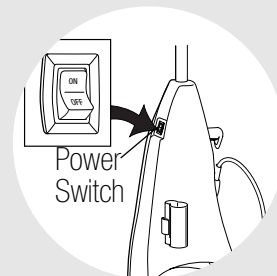
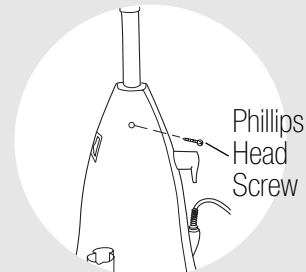
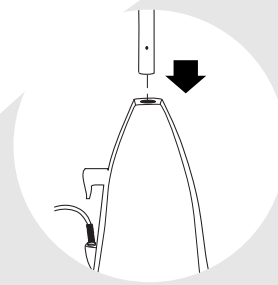

Tip:

Deep cleaning carpeting regularly can reduce dust and allergens in your home.



WARNING:

To reduce the risk of fire, electric shock or injury, unplug from outlet before servicing.

To Fill The Tank-in-Tank

This easy-to-use system is designed with a bladder inside to hold clean water. As you clean, the bladder will empty. Dirty water collects in the tank outside the bladder.

NOTE: Make sure to add formula to the tank before filling it with water.

1. Depress the Handle Release pedal to tilt back the handle.
2. Lift the Tank-in-Tank™ handle. The handle locks the lid in place. Carry the Tank-in-Tank™ like a bucket to fill at the sink.
3. Set the Tank down and rotate the handle forward to unlatch the Lid. Lift off and set the Lid aside.
4. Using the Measuring Cup, pour BISSELL Deep Cleaning Formula into the mouth of the bladder.
5. Fill to the bottom of the neck with hot tap water. Do not boil or microwave water.
NOTE: Fill slowly to reduce sudsing.
6. Replace the Tank Lid, matching the Lid and Tank edges. Rotate the handle to carrying position. Replace Tank in machine base, seating firmly in place. Rotate handle back down to latched position.

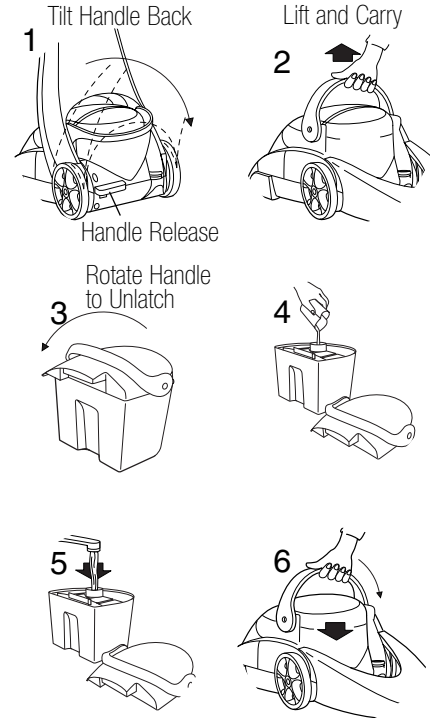

When It's Time To Empty The Tank-in-Tank

NOTE: Remove the Tank-in-Tank, following steps 1 and 2 at the top of the page.

1. Carry the Tank-in-Tank, like a bucket, to the sink. Remove Tank Lid. Pour out dirty water.
2. After each use, remove and rinse the Lint Screen located on the Tank Lid.
 - A. Remove Tank Lid.
 - B. Remove Lint Screen and rinse under faucet. Remove any debris caught in Lint Screen.
 - C. Re-insert Lint Screen on Tank Lid. The screen will click into place.
 - D. Replace Tank Lid.
3. Refill with cleaning solution and clean tap water—follow steps 3-5 above.
4. When a cleaning job is complete, rinse out the Tank-in-Tank by running clean water between the bladder and the tank.
5. Return the Tank-in-Tank to the machine, follow step 6 above.
6. Refer to the Maintenance/Storage section on the next page for final cleanup.

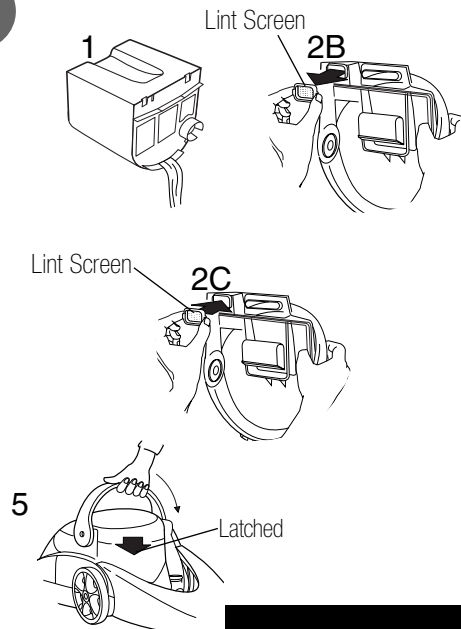

Tip:

A special red float device in the tank will cause the cleaner to stop removing solution from the carpet. The motor sound will rise in pitch to let you know the dirty water tank is full.

Normal Cleaning

1. Plug the PowerSteamer into a proper outlet and turn ON the Power Switch.
2. Make one slow forward and backward wet pass by pushing the SprayTrigger. **Caution: Do not overwet.**
3. Release the Spray Trigger and make one slow forward and back pass over the same area to remove any residual dirty water.
4. Repeat cleaning passes without pressing the Spray Trigger until you can't see any more water being suctioned up.
5. When cleaning job is complete, refer to Maintenance/Storage.

Maintenance/Storage

1. Turn Power Switch OFF.
2. Unplug Power Cord from outlet and coil cord around Power Cord Quick Release.
3. Remove Tank-in-Tank. Dispose of dirty water.
4. Rinse out Tank-in-Tank and re-seat the tank onto the machine.
5. Wipe all exterior surfaces with a soft cloth.
6. Store cleaner in a protected, dry area.
7. When carpet is dry, vacuum again to remove hair and fuzz that the PowerSteamer may have loosened.

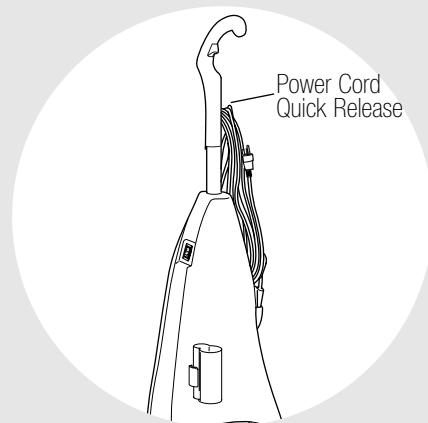

CAUTION:
PowerSteamer uses water and must not be stored where there is a danger of freezing. Freezing will damage internal components and void the warranty.

Pump Belt Replacement

NOTE: Turn off machine and unplug from wall outlet.

To Remove Broken Pump Belt

1. Step on Handle Release pedal and recline Handle on floor (see illustration).
2. Remove the Tank-in-Tank. Set aside (see illustration).

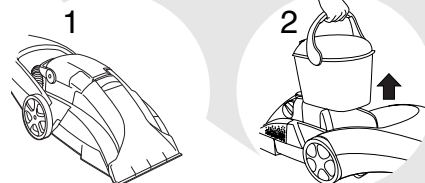

7

To Remove Broken Pump Belt Continued

- 3.** Remove the Belt Access Door. Insert a flathead screwdriver into the slot nearest the handle to gently pry off the door (see illustration).
- 4.** Turn the machine onto its side so the belt access area is facing upward (see illustrations).
- 5.** On the bottom of the machine, near the belt access area, is a White Retainer Plate that holds the black Brush Arm and brush in place. Using a Phillips head screwdriver remove the screw that holds the White Retainer Plate in place. Set White Retainer Plate and Phillips head screw aside (see illustrations).
- 6.** Remove the black Brush Arm that holds the brush in place. Set the black Brush Arm aside (see illustrations).
- 7.** Locate and remove the broken Pump Belt.

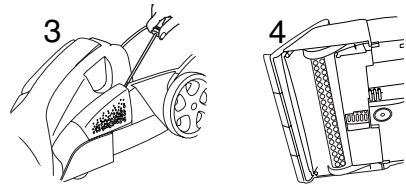

White Retainer Plate

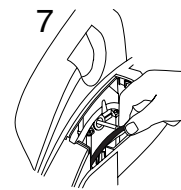
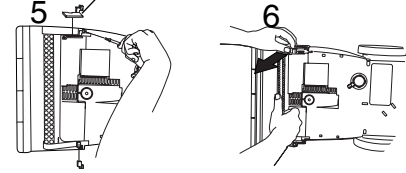

To Replace Broken Pump Belt

- 1.** With the unit still on its side, loop one end of the replacement Pump Belt around the Red Pump Pulley and the other end around the silver motor shaft (see illustration). Do not twist the replacement Pump Belt.
- 2.** Re-install the Brush into the base of the unit.
- 3.** Place the black Brush Arm onto the Brush and slide black Brush Arm into original position (see illustrations). Reattach White Retainer Plate and secure with screw.

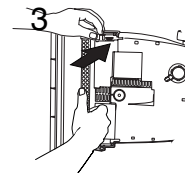
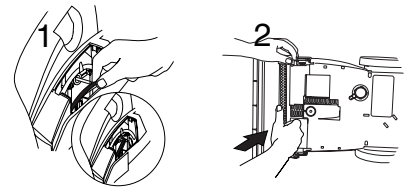

!WARNING:
To reduce the risk of fire,
electric shock, or injury,
unplug machine from
outlet before servicing.

Reduced spray or no spray.

Possible Causes

- ❶ Bladder may be empty
- ❷ The lint screen may be clogged
- ❸ Tank-in-Tank may not be seated properly
- ❹ Pump may have lost prime
- ❺ The Pump Belt may be broken

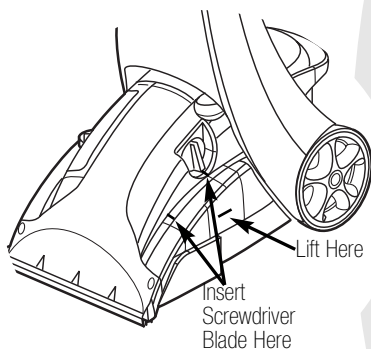

Remedies

- ❶ Turn power OFF; refill tank with hot tap water.
- ❷ Turn power OFF; clean out lint screen, follow step 2 on page 6.
- ❸ Turn power OFF; remove and reseal tank.
- ❹ Turn power OFF; after 1 minute, turn ON and depress Spray trigger.
- ❺ Turn power OFF and unplug machine from outlet. To check if a Pump Belt has broken, you will need a flathead screwdriver. Insert the blade end into the lower slot of the Belt Access Door to release the latch. If necessary, insert the blade end into the upper slot to release the upper latch. Examine for belt breakage. You should be able to see the Pump Belt looped around the motor shaft. If it is broken or missing, please refer to the part numbers and descriptions on page 11 before calling BISSELL Consumer Services. Complete installation instructions will accompany the replacement belt.

PowerSteamer is not picking up solution.

Possible Causes

- ❶ Nozzle Window may not be properly attached
- ❷ Tank-in-Tank Lid is not properly installed
- ❸ Tank-in-Tank is not properly seated
- ❹ Tank-in-Tank has picked up the maximum amount of dirty water

Remedies

- ❶ Make sure the two tabs on the back of the Floor Nozzle Window are inserted through the mating slots in the main housing. Reinstall if necessary.
- ❷ Reinstall lid; refer to page 6.
- ❸ Tank-in-Tank must be firmly seated to function. Remove and reseal Tank-in-Tank.
- ❹ Empty tank and refill; refer to page 6.

Thank you for selecting a BISSELL product.

If you should happen to need assistance during assembly or operation, call: 1-800-237-7691

**Please do not return this
product to the store.**



BISSELL Consumer Services

For information about repairs or replacement parts, or questions about your warranty, call:

BISSELL Consumer Services

1-800-237-7691

Monday - Friday 8 am — 10 pm ET

Saturday 9 am — 8 pm ET

Or write:

BISSELL Homecare, Inc.
PO Box 3606
Grand Rapids MI 49501
ATTN: Consumer Services

Or visit the BISSELL website - **www.bissell.com**

When contacting BISSELL, have model number of unit available.

Please record your Model Number: _____

Please record your Purchase Date: _____

NOTE: Please keep your original sales receipt. It is your warranty.

Part Numbers And Descriptions

Item	Part No.	Part Name
1	015-9043	Tank Assembly Complete
2	015-4439	Tank Lid Assembly
3	015-9041	Tank Bottom
4	213-0213	Baffle with Red Float
5	213-3501	Lint Screen
6	215-0628	Pump Belt
7	0710	48 oz. BISSELL Fiber Cleansing Formula with Scotchgard™ Protector
8	0720	48 oz. BISSELL Multi-Allergen Formula with Scotchgard™ Protector
9	0400	22 oz. BISSELL Tough Stain PreCleaner

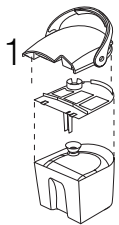

2



3

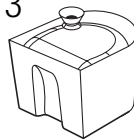

4

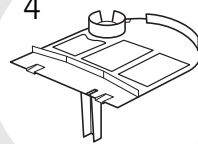

5



6



7



8



9



About Your Warranty

This warranty gives you specific legal rights, and you may also have other rights which may vary from state to state. If you need additional instruction regarding this warranty or have questions regarding what it may cover, please contact BISSELL Consumer Services by E-mail, telephone, or regular mail as described below.

Limited **One** Year Warranty

Subject to the *EXCEPTIONS AND EXCLUSIONS identified below, upon receipt of the product, BISSELL Homecare, Inc. will repair or replace (with new or remanufactured components or products), at BISSELL's option, free of charge from the date of purchase by the original purchaser, for one year any defective or malfunctioning part.

See information below on "If your BISSELL product should require service".

This warranty applies to product used for personal, and not commercial or rental service. This warranty does not apply to fans or routine maintenance components such as filters, belts, or brushes. Damage or malfunction caused by negligence, abuse, neglect, unauthorized repair, or any other use not in accordance with the User's Guide is not covered.

If your BISSELL product should require service:

Contact BISSELL Consumer Services to locate a BISSELL Authorized Service Center in your area.

If you need information about repairs or replacement parts, or if you have questions about your warranty, contact **BISSELL Consumer Services**.

Website or E-mail:

www.bissell.com

Use the "Customer Service" tab.

Or Call:

BISSELL Consumer Services

1-800-237-7691

Monday - Friday 8 am - 10 pm ET

Saturday 9 am - 8 pm ET

Or write:

BISSELL Homecare, Inc.

PO Box 3606

Grand Rapids MI 49501

ATTN: Consumer Services

BISSELL HOMECARE, INC. IS NOT LIABLE FOR INCIDENTAL OR CONSEQUENTIAL DAMAGES OF ANY NATURE ASSOCIATED WITH THE USE OF THIS PRODUCT. BISSELL'S LIABILITY WILL NOT EXCEED THE PURCHASE PRICE OF THE PRODUCT.

Some states do not allow the exclusion or limitation of incidental or consequential damages, so the above limitation or exclusion may not apply to you.

*EXCEPTIONS AND EXCLUSIONS FROM THE TERMS OF THE **LIMITED** WARRANTY

THIS WARRANTY IS EXCLUSIVE AND IN LIEU OF ANY OTHER WARRANTIES EITHER ORAL OR WRITTEN. ANY IMPLIED WARRANTIES WHICH MAY ARISE BY OPERATION OF LAW, INCLUDING THE IMPLIED WARRANTIES OF MERCHANTABILITY AND FITNESS FOR A PARTICULAR PURPOSE, ARE LIMITED TO THE TWO YEAR DURATION FROM THE DATE OF PURCHASE AS DESCRIBED ABOVE.

Some states do not allow limitations on how long an implied warranty lasts, so the above limitation may not apply to you.



©2003 BISSELL Homecare, Inc.
Grand Rapids, Michigan
All rights reserved. Printed in USA.
Part Number 310-2515
Rev 6/03

Visit our website at:
www.bissell.com
Scotchgard is a trademark of 3M