

This Owner's Manual is provided and hosted by [Appliance Factory Parts](http://ApplianceFactoryParts.com).

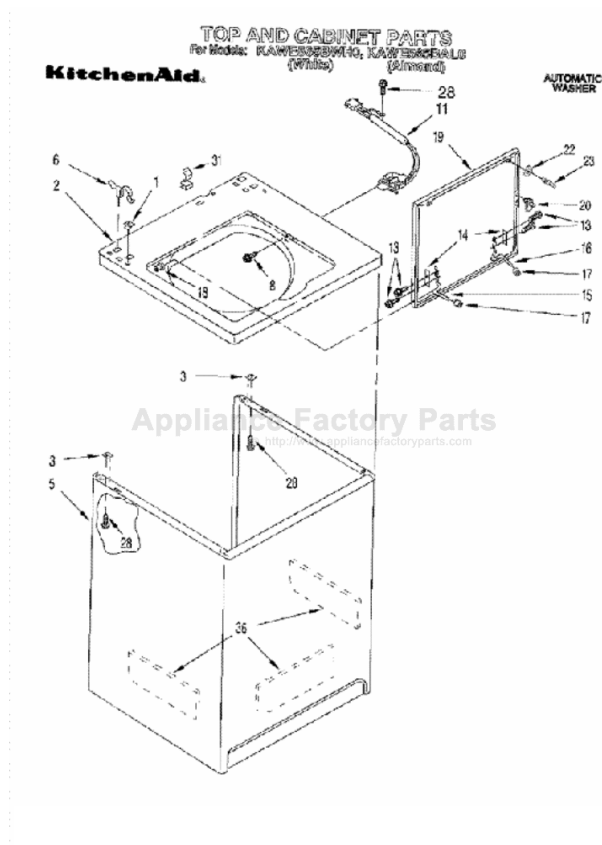

KITCHENAID KAWE565BWH0 Owner's Manual

[Shop genuine replacement parts for KITCHENAID
KAWE565BWH0](#)



[Find Your KITCHENAID Washer Parts - Select From 132 Models](#)

----- Manual continues below -----

Use and Care Guide

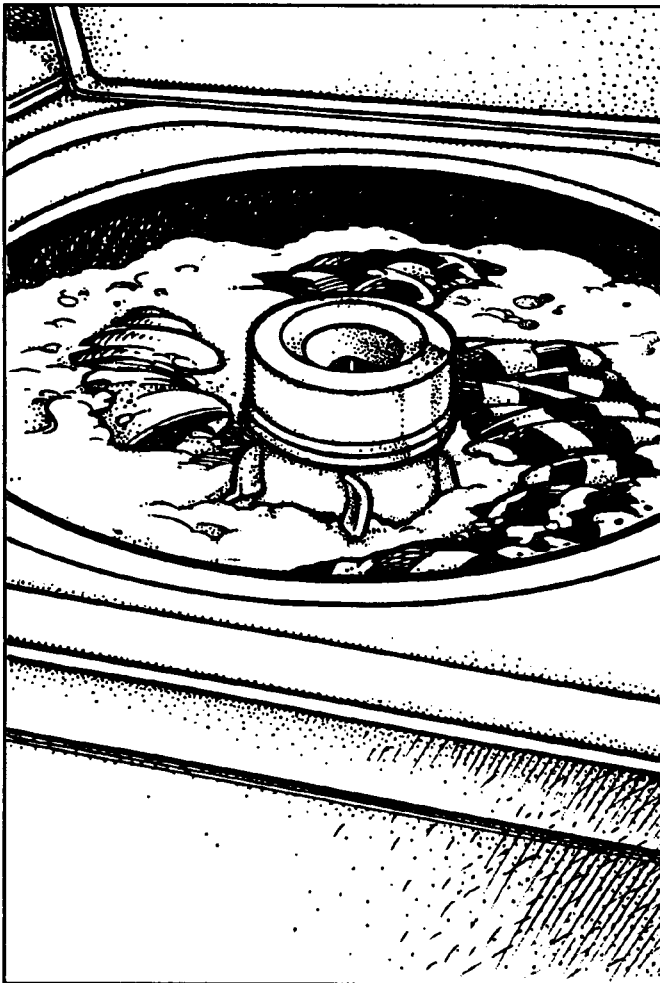

KitchenAid®
FOR THE WAY IT'S MADE.™

A Note to You	2
Understanding Washer Safety	3
Getting to Know Your Washer	4
Operating Your Washer	5
Other Features	11
Caring for Your Washer	13
Laundry Tips	14
Removing Stains	19
Troubleshooting	22
If You Need Assistance or Service	24
Warranty	28

1-800-422-1230

Call with questions or comments.

KITCHENAID® Washers

Models: KAWE565B KAWE570B KAWE577B KAWE578B
KAWE665B KAWE667B KAWE668B

12194

A Note to You

Thank you for buying a KitchenAid® appliance!

KitchenAid appliances have everything you would expect of a superior appliance, plus the distinct style and thoughtful details which contribute to the overall look of your home and your enjoyment of it. To ensure that you enjoy many years of trouble-free operation, we developed this Use and Care Guide. It contains valuable information concerning how to operate and maintain your new appliance properly and safely. Please read it carefully. Also, please complete and mail the enclosed Product Registration Card.

Our Consumer Assistance Center telephone number, 1-800-422-1230, is toll-free 24 hours a day.

If you have a question concerning your home appliance's operation, or if you need service, call our toll-free Consumer Assistance Center telephone number for help. When calling, you will need to know your appliance's complete model number and serial number. You can find this information on the model and serial number plate (see diagram on page 4). Record these numbers and purchase information below. You will need this information if you require service. Keep this book and the sales slip together in a safe place for future reference.

NOTE: You must provide proof of purchase or installation date for in-warranty service.

Model Number _____ Builder/Dealer Name _____
Serial Number _____ Address _____
Date Installed _____ Phone _____

Understanding Washer Safety

Your safety is important to us.

This guide contains safety statements under warning symbols. Please pay special attention to these symbols and follow any instructions given. Here is a brief explanation of the symbol.

WARNING

This symbol alerts you to such dangers as personal injury, burns, fire, and electrical shock.

IMPORTANT SAFETY INSTRUCTIONS

WARNING

To reduce the risk of fire, electrical shock, or injury when using your washer, follow basic precautions including the following:

- Read all instructions before using your washer.
 - Do not machine wash or machine dry items cleaned, washed, soaked in, or spotted with wax, paint, gasoline, oil, or other flammable fluids. The fumes can create a fire hazard or explosion. Always hand wash and line dry items containing these materials.
 - Flammable fluids (dry-cleaning solvents, kerosene, gasoline, etc.) should not be used or stored in or near your washer. Do not add flammable fluids to your wash water. These substances give off vapors that can create a fire hazard or explosion.
 - Do not allow children to operate, play with, or crawl on or inside your washer. Supervise children closely when your washer is used near them.
 - Before your washer is removed from service or discarded, remove the lid to prevent accidental entrapment.
 - After starting a cycle, do not reach into the basket unless the Cycle Control Knob is pushed in and all motion stops.
 - Do not tamper with the controls.
 - If your hot water has not been used recently (usually 2 weeks or longer), hydrogen gases may build up in your water heater and your hot water pipes. **HYDROGEN GAS IS EXPLOSIVE.** To prevent injury or damage, before using your washer, turn on all hot water faucets and allow water to run for several minutes. This will allow gases to escape. Do not smoke or use any open flame near your faucet while it is open.
- Please ...
- Have only a qualified person install, repair, or replace parts on washer.
 - Maintain washer properly.
 - Protect washer from the weather and keep it where the temperature will not fall below freezing.
 - Install and level washer on a floor that can support the weight.*
 - Connect washer to the correct 3-prong outlet, electrical supply, water supply, and drain.*
 - Ground washer properly.*
- *See the Installation Instructions.

– SAVE THESE INSTRUCTIONS –

Understanding your responsibilities

- Store laundry aids and other materials in a cool, dry place where children cannot reach them (in a locked cabinet if possible).
- Read and follow instructions on packages of detergent and laundry aids, especially warnings and precautions.
- Do not wash or dry items that are soiled with vegetable or cooking oil. These items may contain some oil after laundering. Due to the remaining oil, the fabric may smoke or catch fire by itself.
- Do not use chlorine bleach and ammonia or acids (such as vinegar or rust remover) in the same wash. Hazardous fumes can form.
- Unplug power supply cord before attempting to service your washer.
- Do not machine wash fiberglass materials. Small particles can stick to fabrics washed in following loads and cause skin irritation.

Getting to Know Your Washer

The parts and features of your washer are illustrated in this section. Become familiar with all parts and features before using your washer.

NOTES:

- The drawings in this book may vary from your washer model. They are designed to show the different features of all models covered by this book. Your model may not include all features.
- Page references are included next to some features. Refer to those pages for more information about the features.

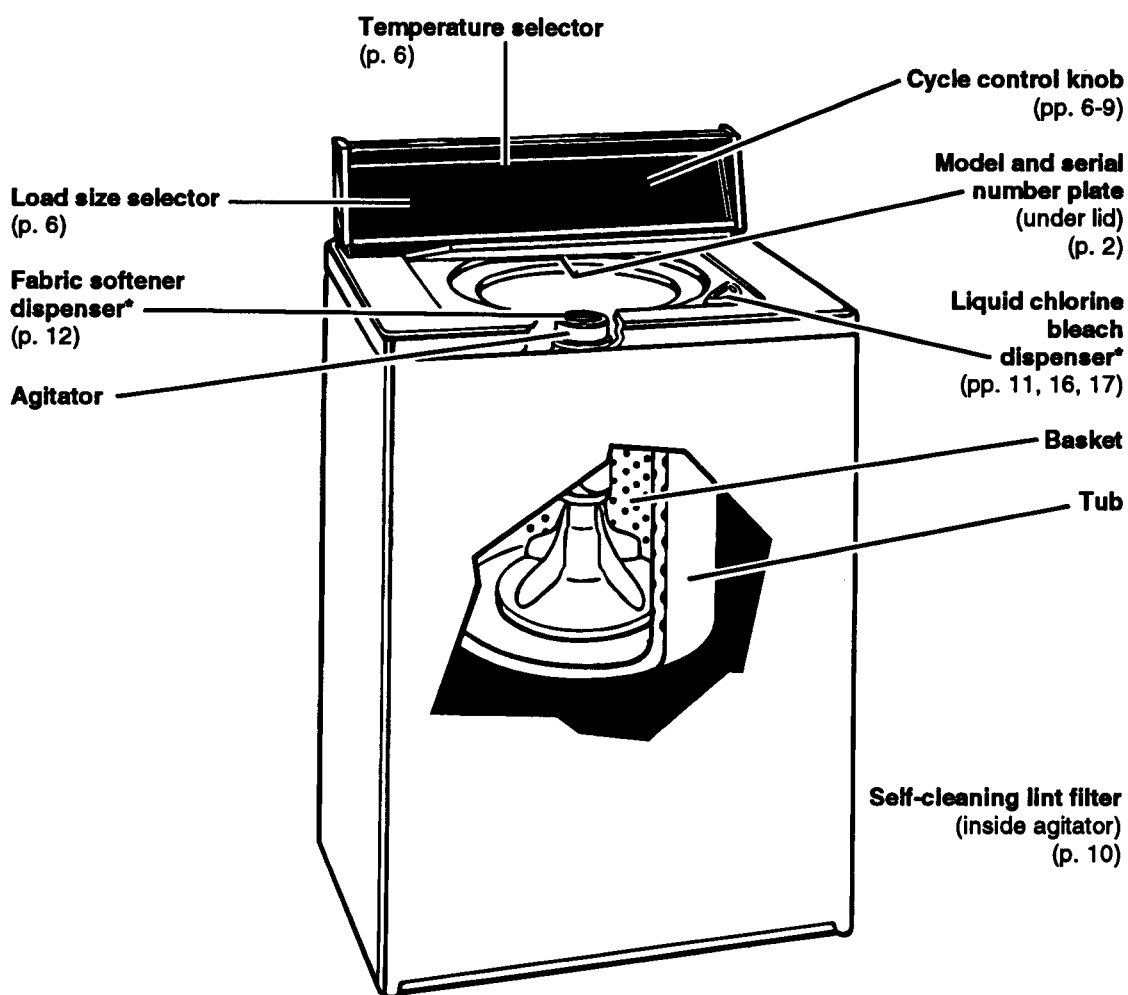

*Available on some models

Operating Your Washer

This section tells you how to operate your washer. Operating your washer properly enables you to obtain the best possible results.

IN THIS SECTION		Page	Page
Before starting your washer	5	Selecting a cycle and setting	6
Starting or stopping your washer	5	Using rinse and spin	9
Selecting a load size	6	Using drain and spin	9
Selecting wash-rinse temperatures	6	What happens in each cycle	10
		Self-cleaning lint filter	10

Before starting your washer

Add measured detergent. Then place a sorted load in the washer. Refer to the "Laundry Tips" section on pages 14 and 15 for more information.

NOTE: If your washer has a Consumer Buy Guide, remove it and place it in this Use and Care Guide.

Starting or stopping your washer

To start your washer:

1. Select a load size and water temperature as described on page 6.
2. Push in and turn the Cycle Control Knob clockwise. Stop when the indicator on the knob's outer ring points to the setting in the wash cycle you want. (See pages 7-9.) The settings indicate soil level.
3. Pull out the Cycle Control Knob.

To stop/restart your washer:

- To stop the washer at any time, push in the Cycle Control Knob.
- To restart the washer, close the lid (if necessary) and pull out the Cycle Control Knob.



Cycles may vary with model

Selecting a load size

Turn the Load Size Selector to the setting that corresponds with the size of your wash load and the type of fabric being washed. See page 14 for loading suggestions.

To change the load size setting after the washer has started to fill, turn the Selector to the desired new setting.

NOTE: If you select the largest load size, the washer fills to the highest water level (near the top of the basket, not to the top of the agitator).

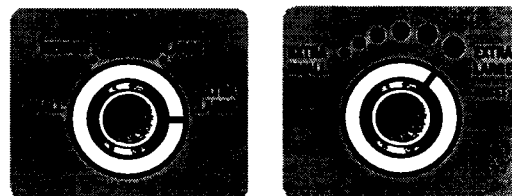

Settings may vary with model

If your selector has RESET

To change the load size selection after the washer starts filling, first move the Selector to RESET, then to the new load size.

Selecting wash-rinse temperatures

Match the water temperature with the type of fabric and soils being washed. The top temperature is the wash water and the bottom temperature is the rinse water.

See pages 15 and 16 for water temperature guidelines.

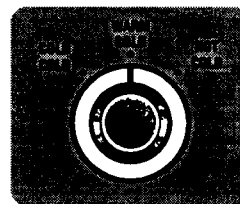

Selecting a cycle and setting

You will find information you need to help you make correct cycle selections in this section.

- Pages 7-9: Use the information on these pages to guide you when selecting a wash cycle and time.
- Page 10: Use this page to help you understand what happens during a wash cycle.

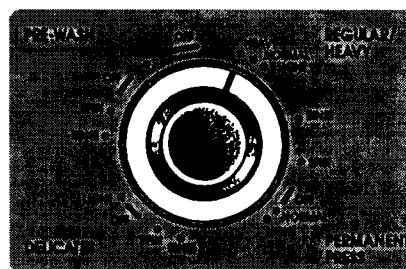

Cycles may vary with model

Regular/Heavy cycle

The Regular/Heavy cycle features high spin speeds designed to shorten drying time.

- Use **HEAVY** to clean large loads of sturdily constructed cotton and linen fabrics that are heavily soiled.
- Use **NORMAL** to clean sturdily constructed cotton and linen fabrics that are moderately soiled.
- Use **LIGHT** to clean sturdily constructed cotton and linen fabrics that are lightly soiled.



Regular/Heavy cycle

Permanent Press cycle

The Permanent Press cycle features a cool-down rinse and low spin speeds to reduce wrinkling.

- Use **NORMAL** to clean permanent press and some synthetic fabrics that are moderately soiled.
- Use **LIGHT** to clean permanent press and some synthetic fabrics that are lightly soiled.

NOTE: The washer pauses briefly during the wash cycle. This is normal for washer operation.

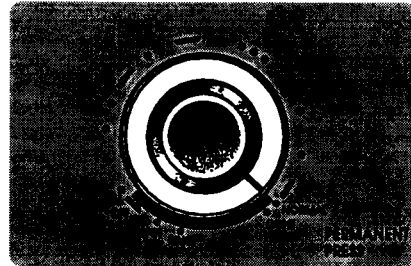

Permanent Press cycle

Delicates cycle

The Delicates cycle features a brief wash cycle. Low spin speeds reduce wrinkling.

- Use **LIGHT** to clean lightly to moderately soiled delicate items and washable knits.

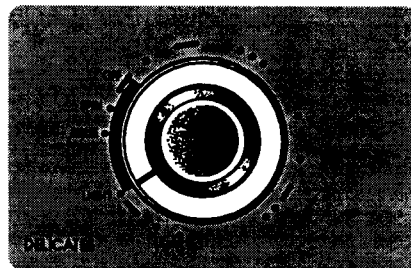

Delicates cycle

Pre-Wash cycle

The Pre-Wash cycle features a brief period of agitation and high spin speeds to help remove heavy soils and stains that need pretreatment.

- Use warm water for prewashing stained laundry. (Hot water can set stains.) See pages 19-21 for stain removal information.
- After the Pre-Wash cycle ends, add detergent and set a new wash cycle.

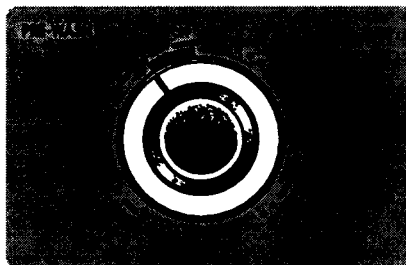

Pre-Wash cycle

Soak/Pre-Wash cycle

(on some models)

The Soak cycle features brief periods of agitation and soak time to help remove heavy soils and stains that need pretreatment.

- Use warm water when soaking laundry. (Hot water can set stains.) See pages 19-21 for stain removal information.
- Use the amount of detergent or presoak additive recommended by manufacturer.
- The Soak cycle automatically advances into Pre-Wash.

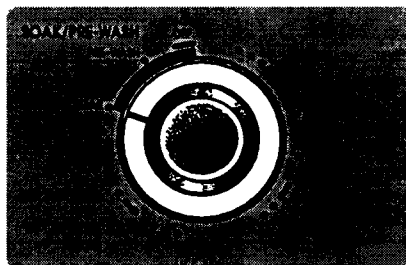

Soak/Pre-Wash cycle

Extra Wash cycle

(on some models)

Extra Wash automatically prewashes the laundry and advances into the Regular/Heavy cycle. (The washer does not need to be reset after the Extra Wash cycle.) Use this cycle when washing heavily soiled loads that need maximum soil removal.

- For proper cleaning, use double the amount of detergent recommended for a wash cycle.

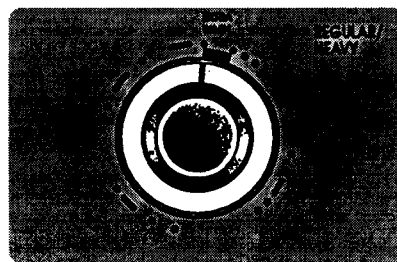

Extra Wash cycle

NOTE: The machine pauses during Extra Wash. This is normal for washer operation.

Using rinse and spin

When using extra detergent for heavily soiled clothes, or washing special-care items, you may want an extra rinse and spin.

1. Push in the Cycle Control Knob and turn clockwise to RINSE, as illustrated.
2. Pull out the Cycle Control Knob. The washer fills to selected load size, agitates, drains, and spins.

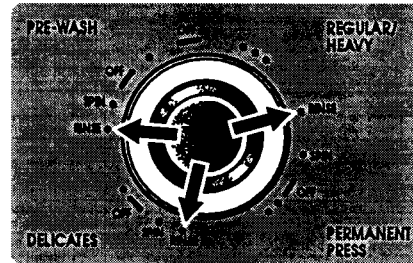

Using drain and spin

A drain and spin may help shorten drying times for some heavy fabrics or special-care items by removing excess water.

1. Push in the Cycle Control Knob and turn clockwise to SPIN, as illustrated.
2. Pull out the Cycle Control Knob. The washer drains, then spins.

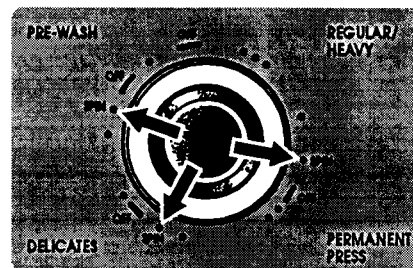

What happens in each cycle

When the Cycle Control Knob is turned to a setting and pulled out, the washer fills (to the selected load size) before agitation and timing start. The washer begins agitating immediately after filling; agitation can occur with the washer lid up or down.

After agitation starts, the Cycle Control Knob turns clockwise until it points to OFF and the cycle ends.

The washer pauses briefly throughout each cycle. These pauses are normal for washer operation.

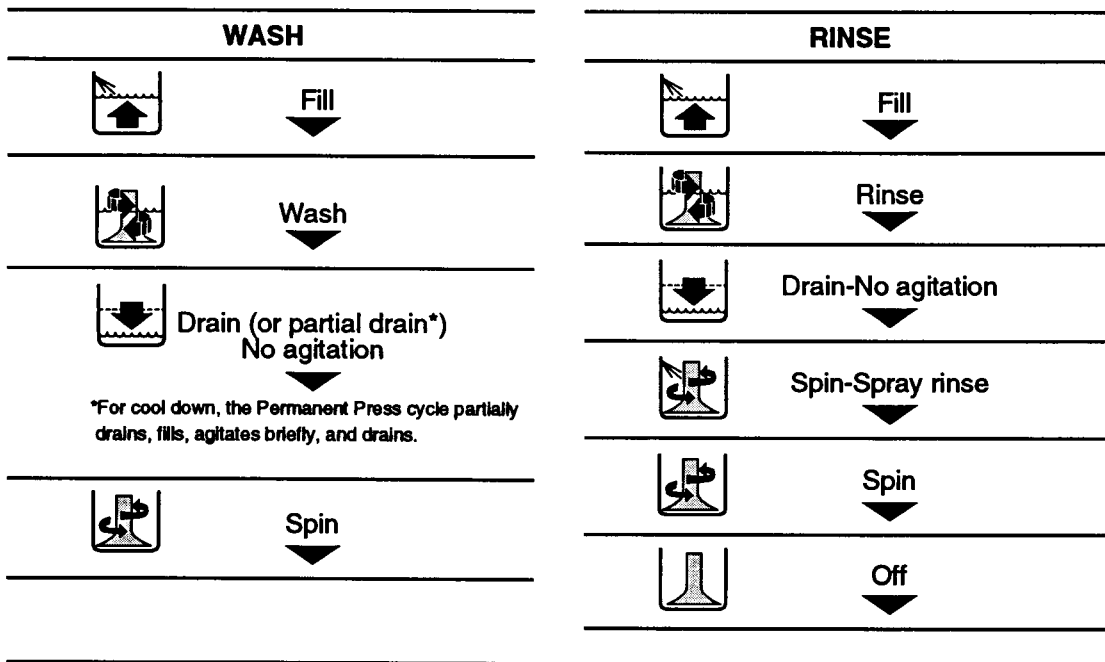

Self-cleaning lint filter

Your washer has a self-cleaning lint filter at the bottom of the washer basket. During agitation, wash and rinse water pass over the filter, separating the lint from the water. The lint is then spun away from the filter and out of the system during the spin part of the cycle.

If your washer drains into a tub, remove any lint collected in the tub or strainer.

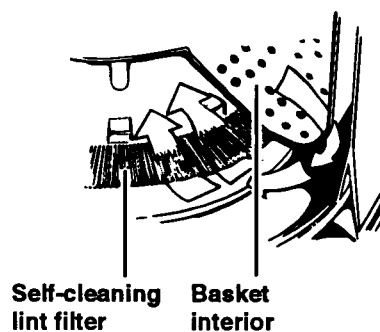

Other Features

Your washer may have some of the following features. Understanding the use of the features on your machine will help you efficiently use your washer.

IN THIS SECTION	
	Page
Using the Extra Rinse option	11
Using the liquid chlorine bleach dispenser	11
Using the fabric softener dispenser	12

Using the Extra Rinse option

(on some models)

You can select an extra rinse in the Regular/Heavy cycle.

- Before the cycle starts, select Extra Rinse ON. The washer automatically adds an extra rinse and spin to the cycle.
- If no extra rinse and spin are desired, select Extra Rinse OFF.

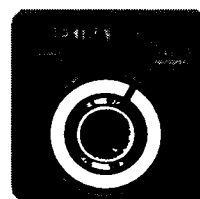

Using the liquid chlorine bleach dispenser

(on some models)

See pages 16 and 17 if you do not have a chlorine bleach dispenser.

Always measure liquid chlorine bleach. Do not guess. Never use more than 1 cup (250 mL) for a full load. Use less with lower water level settings. Follow manufacturer's directions for safe use. Use a cup with a pouring spout to avoid spilling.

1. Load the washer.
2. Pour measured chlorine bleach carefully into dispenser. Do not let bleach splash, drip, or run down into washer basket. Undiluted bleach will damage any fabric it touches.
3. Start the washer. Bleach will be diluted automatically during the wash part of the cycle.

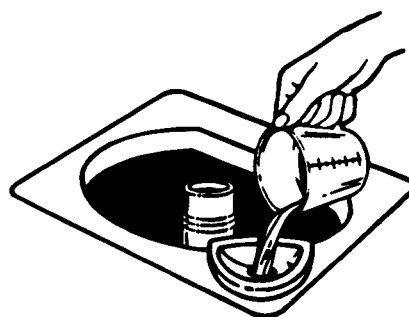

NOTE: Do not use this dispenser to add powdered chlorine or all-fabric bleach to your wash load. The dispenser is for liquid chlorine bleach use only.

Using the fabric softener dispenser

(on some models)

If the top of the agitator has a pouring well with a cross-bar at the bottom, your model has a fabric softener dispenser. See page 17 if you do not have a fabric softener dispenser.

1. Add detergent and load the basket.
2. Pour liquid fabric softener into the dispenser using the amount recommended on the package. Avoid dripping or spilling any fabric softener on the load.
3. Dilute fabric softener with warm water. Fill dispenser with warm water until liquid reaches the cross-bar in the pouring well.
4. Start the washer. Diluted fabric softener will be added to the load during the first rinse.

NOTE: Do not stop the washer before the final rinse begins. Staining can occur.

Flush dispenser periodically with warm water.

- To remove the dispenser, grasp the top of the dispenser with both hands. Squeeze and push upward with thumbs to remove.
- Clean dispenser by holding under water faucet. Replace after cleaning.

NOTE: Do not wash clothes with this dispenser removed. Do not add detergent or bleach to dispenser. The dispenser is for fabric softener use only.

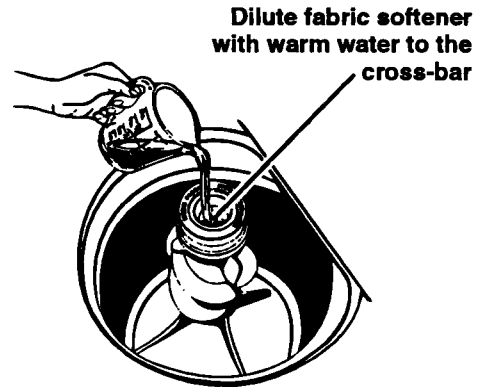

Add fabric softener and water



Clean the dispenser

Caring for Your Washer

Proper care of your washer can extend its life. This section explains how to care for your washer properly and safely.

Cleaning your washer

Exterior



Wipe up detergent, bleach, and other spills with a soft, damp cloth or sponge as they occur. Occasionally wipe the outside of the washer to keep it looking like new.



Do not put sharp or metal objects in your washer. They can damage the finish. Check all pockets for pins, clips, money, bolts, nuts, etc.

Do not lay these objects on your washer after emptying pockets.

Interior

Clean interior with 1 cup (250 mL) of chlorine bleach mixed with 2 cups (500 mL) of detergent. Run washer through a complete cycle using hot water. Repeat process if necessary.

NOTE: Remove hard water deposits using cleaners labeled as washer safe only.

Winter storage or moving care

Install and store your washer where it will not freeze. Because some water may stay in the hoses, freezing can damage your washer. If storing or moving your washer during freezing weather, winterize it.

To winterize washer:

1. Shut off both water faucets.
2. Disconnect and drain water inlet hoses.
3. Put 1 quart (1L) of R.V.-type antifreeze in the basket.
4. Run washer on a drain and spin setting (see page 9) for about 30 seconds to mix the antifreeze and water.
5. Unplug the power supply cord.

To use washer again:

1. Flush water pipes and hoses.
2. Reconnect water inlet hoses.
3. Turn on both water faucets.
4. Reconnect power supply cord.
5. Run the washer through a complete cycle with 1 cup (250 mL) of detergent to clean out antifreeze.

Non-use or vacation care

You should operate your washer only when you are at home. If you will be on vacation or not using your washer for an extended period of time, you should:

- Unplug the power supply cord or turn off electrical power to the washer.

- Turn off the water supply to the washer. This helps avoid accidental flooding (due to a water pressure surge) while you are away.

Laundry Tips

This section reviews proper laundering techniques, gives you additional washing information, and discusses solutions to common laundering problems.

IN THIS SECTION

	Page	Page	
Before you wash	14	Using laundry aids	16
Water guidelines	15	Washing special-care items	18

Before you wash

Preparing clothes for washing

- Close zippers, snaps, and hooks to avoid snagging other items. Remove pins, buckles, and other hard objects to avoid scratching the washer interior. Remove un-washable trim and ornaments.



- Empty pockets and turn them inside out.
- Turn down cuffs and brush away lint and dirt.
- Turn synthetic knits inside

out to avoid pilling.

- Tie strings and sashes so they will not tangle.
- Mend tears, loose hems, and seams.
- Treat spots and stains. (See pages 19-21 for pretreatment and stain removal information.)
- Stained or wet garments should be washed promptly for best results.

Sorting

- Separate heavily soiled items from lightly soiled ones even if they would normally be washed together. Separate lint givers (towels, chenille) from lint takers (corduroy, synthetics, permanent press). When possible, turn lint givers inside out.



- Separate dark from light colors, colorfast from

noncolorfast.

- Sort by fabric and construction (sturdy cottons, knits, delicate items).

Loading

- Drop items into washer loosely. Fill to the top of the basket, but do not pack or wrap items around the agitator. Items should move easily through wash water for best cleaning and wrinkle-free results. Watch for rollover. Items should sink and reappear later.



- Load washer properly. Overloading can:
 - cause poor cleaning.
 - increase wrinkling.
 - create excessive lint.
 - wear out items faster (because of pilling).
- Load by the amount of space items take up, not by their weight.
- Mix large and small items in each load. Load evenly to maintain washer balance.



An off-balance load can make the machine vibrate during spin. To reduce wrinkling, permanent press and synthetic knits should have more

room to move in the water than heavy items (towels, jeans).

- Do not select a load size that is too small for the wash load. Use a large load size setting for permanent press clothes.
- Reduce wash time when using a small load size setting. Loads with only a few small items need less wash time.

Loading suggestions:

For these suggested full-sized loads, use the highest load size setting.

EXTRA LARGE CAPACITY WASHERS			
Heavy Work Clothes 3 pair pants 3 shirts 4 pair jeans 1 coverall 1 overall	Permanent Press 2 double or 1 king size sheet 1 tablecloth 1 dress 1 blouse 2 slacks 3 shirts 2 pillowcases	Towels 10 bath towels 10 hand towels 14 wash cloths 1 bath mat Delicates 3 camisoles 1 quilted robe 4 slips 4 panties 2 bras 2 nighties 1 baby's dress	Mixed Load 3 double sheets 4 pillowcases 8 T-shirts 6 pair shorts 2 shirts 2 blouses 8 handkerchiefs
Knits 3 slacks 3 blouses 6 shirts 4 tops 4 dresses			

Water guidelines

Selecting water temperatures

WASH WATER TEMPERATURE	SUGGESTED FABRICS	COMMENTS
HOT 130°F (54°C) or above	<ul style="list-style-type: none"> • Work clothes • Sturdy whites/colorfast pastels • Diapers 	<ul style="list-style-type: none"> • Best cleaning for heavily soiled items • Removes oils, perspiration, greasy soils, and stains • Prevents graying or yellowing
WARM 90° – 110°F (32° – 44°C)	<ul style="list-style-type: none"> • Dark/noncolorfast colors • Permanent press items • Nylon, polyester, acrylics, silks, woolens • Knits/delicate fabrics 	<ul style="list-style-type: none"> • Best for moderately soiled to lightly soiled items • Safe for most fabric finishes • Less fading and dye bleeding • Reduces wrinkling
COLD 70° – 90°F (21° – 32°C)	<ul style="list-style-type: none"> • Extra-sensitive colors • Noncolorfast items • Hand washables 	<ul style="list-style-type: none"> • Best for very lightly soiled items • Saves hot water • Best rinse water temperature

Checking hot water temperature

Your hot water should be 130°F (54°C) or above. To check water temperature:

1. Fill a pan with the hottest water available from the faucet that fills your washer.

NOTE: If you do not have a faucet at your washer site, collect the water from the faucet closest to your washer.

2. Place a candy or cooking thermometer in the water to check the temperature.
3. Raise the temperature of your water heater if necessary.

NOTE: In wash-water temperatures colder than 70°F (21°C), detergents do not dissolve well. Also, soils may be difficult to remove, and some fabrics may retain wear wrinkles and may have increased pilling.

Water hardness

Many poor washing results can be traced to the hardness of the wash water. To check your water hardness:

- City water – ask the city water company.
- Well water – ask the local water authority.

Ask for the mineral content in grains/gallon or parts/million. If your water is more than 8 grains/gallon or more than 153 parts/million, you should consider:

- Installing a water softener.

- Using more detergent.
- Using a packaged water conditioner.
- Not using soap.

Saving energy

- Use warm or cold wash water for most loads. Use hot water only when washing heavy, greasy soils or whites.
- Use cold rinses.
- Wash full loads.
- Use lower water levels when washing small loads.
- Avoid rewashing. Use enough detergent. Pretreat stains or heavy soils.
- Do not overload; use the cycles and wash times recommended for the fabric and soil.
- Use your washer during off-peak hours – usually early morning and late evening. (Ask your power company.)

Using laundry aids

Follow package instructions when using laundry aids. (See “Removing Stains” on pages 19-21 for more information.)

All-fabric bleach

- Powdered or liquid all-fabric bleach may be used on all types of fabrics.
- Do not use all-fabric bleach in the bleach dispenser because it may clog.

Chlorine bleach

- Use bleach dispenser if your machine has one. (See page 11.)
- If your washer does not have a bleach dispenser:
 1. Let the washer fill and begin agitating the load.
 2. Measure bleach. Never use more than 1 cup (250 mL) for a full load. Dilute bleach in 1 quart (1 L) of water.

3. Add bleach to wash cycle so it can be removed in the rinse cycle. Pour bleach around agitator, not directly on load.
- Follow directions on care labels. Do not use chlorine bleach on wool, silk, spandex, acetates, or some flame-retardant fabrics.
- When soaking with liquid chlorine bleach, add detergent to soak water.

NOTE: Undiluted bleach will damage any fabric it touches. The damage appears as rips, holes, tears, or color loss and may not show up until several washings later.

WARNING

Fire or Explosion Hazard

- Store flammable solvents or liquids away from your washer.
- Dry cleaning solvents or fluids should not be put directly into your washer.
- Items treated with solvents should be rinsed and air dried before washing in your washer.

The fumes from these substances can create a fire hazard or explosion.

Personal Injury Hazard

- Never use chlorine bleach with ammonia or acids. Hazardous fumes can form.
- Keep stain removal products out of the reach of children ... preferably in a locked cabinet.

Detergent

- Using too little detergent is a common cause of laundry problems. Follow manufacturer's directions. Measure accurately, especially when using ultra detergents. Package directions are usually based on:
 - moderate water hardness (4-6 grains)
 - lightly soiled items
 - normal wash loads.
- Use more detergent for:
 - hard water
 - cooler wash water
 - full loads
 - heavily soiled items.
- Do not judge the amount of detergent to use by the amount of suds in the machine. Low sudsing detergents do not create as many suds as normal sudsing detergents.
- If the recommended amount of normal sudsing detergent creates too many suds or suds are present in the rinse water, try a low sudsing detergent.

Fabric softeners

- Use fabric softener dispenser if your washer has one. (See page 12.)
- If your washer does not have a fabric softener dispenser, add diluted fabric softener only in the final rinse.
- Always dilute fabric softeners with $\frac{1}{2}$ to 1 cup (125 to 250 mL) warm water. Undiluted fabric softener can stain fabrics.
- Fabric softeners should not be mixed with other laundry products because greasy stains may form. If stains form, remove by wetting the stain and rubbing with liquid detergent or a bar of soap. Rewash the stained item.
- Too much fabric softener can make some items (diapers and towels) nonabsorbent. If this happens, use less fabric softener or do not use it every time.

Washing special-care items

Most garments and household textiles have care labels with laundering instructions. **Always follow care label directions when they are available.** Below are general washing instructions for some special washables.

ITEM	CARE INSTRUCTIONS
Blankets (electric or woolen)	Pretreat spots and stains. Select water temperature, cycle, and time according to the type of blanket being washed. Two rinses may be necessary. Check care label to see if manufacturer recommends machine washing.
Curtains, drapes, slipcovers	Wash small loads. Crowding may cause wrinkling. Replace slipcovers while still slightly damp. They will dry to fit tightly. NOTE: Sun-damaged curtains and draperies will tear whether hand or machine washed.
Diapers	When using chlorine bleach for soaking, add extra detergent to the load. Avoid overuse of fabric softeners – absorbency will be reduced.
Elastic, spandex	Elastic picks up oil from the body. Oil can damage elastic. Wash often to reduce the damage. Use warm water and sufficient detergent to remove oils. Do not use chlorine bleach.
Flame-retardant clothing	Items will be clearly labeled as flame-retardant. Follow manufacturer's instructions to retain flame-retardant qualities.
Knits	Knits are comfortable to wear because they stretch. However, this means that knits are more likely to be stretched and damaged when washed (especially bulky knits). Knits made of synthetic fabrics such as polyester, nylon, and acrylic tend to keep their original shape more than a knit made of cotton or ramie.
Pillows, stuffed toys	Washing feather pillows is not recommended unless they will be dried in a dryer.
Plastic, rubber items	Treat as delicate items. Wash in warm water. Wash small items in a mesh bag.
Quilts, bedspreads	Do not wash cotton-filled comforters unless they are quilted or stitched. Tucked cotton batting tends to slip and become lumpy. An extra rinse may be necessary.
Scatter rugs	Shake or vacuum rugs to remove loose dirt. Wash more than one rug at a time. If washing only one rug, add bath towels to balance the load.
Snowsuits, jackets	Wash only one or two items at a time. You may need to stop the washer occasionally to press air from the items being washed. An extra rinse may be necessary.

Removing Stains

Stained, heavily-soiled, or greasy items may need to be prewashed or soaked for best results. Soaking helps remove protein-type stains like blood, milk, or grass. Prewashing helps loosen soil before washing.

Stain removal rules

- Use warm water for soaking or prewashing stained laundry. Hot water can set stains.
- Most stains are easier to remove when they are fresh. Old or set stains may not come out. Follow package directions for pretreatment products.
- Before treating any stain, find out what kind of stain it is, how old the stain is, what kind of fabric it is, and if the fabric is colorfast. (Check the care label.)
- Washing and drying can set some stains.
- Start with cold or warm water. Hot water can set some stains.
- When bleach is recommended, use a bleach that is safe for the fabric.
- Test stain removers on an inside seam or hidden corner of the item to see if the color is removed.
- Put the stained area face down on a paper towel or white cloth. Apply the stain remover to the back of the stain. This forces the stain off the fabric instead of through it.
- Meat tenderizer or enzyme presoaks help break down some protein stains so they are easier to remove.

Stain removal guide

STAIN	TO REMOVE
Alcoholic beverage	These stains turn brown with age, so treat immediately. Sponge or soak fresh stains with cold water. Wash. If stain remains, soak 15 minutes in a solution of lukewarm water, liquid detergent, and a few drops of white vinegar. Rinse. Wash.
Blood	Rinse immediately or soak in cold water with enzyme presoak for 30 minutes or longer. Rinse. Rub detergent into any remaining stains. Rinse. If stain remains, put a few drops of 3% hydrogen peroxide on stain for 3-5 minutes. Rinse thoroughly. Wash.
Chewing gum	Use ice to make gum hard. Scrape off what you can. Sponge with a nonflammable fabric cleaner. Let dry. Wash.
Chocolate or coffee	Sponge immediately with a nonflammable fabric cleaner or apply a prewash soil and stain remover. Rinse. Wash. If stain remains, apply a liquid detergent to stain or soak in warm water with an enzyme presoak. Rewash.
Crayon and candle wax	Scrape off excess with a dull knife. Place fabric between two blotters or facial tissue. Press with warm iron. Remove color stain with nonflammable fabric cleaner. Hand wash until stain is gone. If full load is crayon stained, take to cleaners or coin-operated dry cleaning machine.
Cream, milk, or ice cream	Sponge with a nonflammable fabric cleaner, or a prewash soil and stain remover. Rinse. Wash. Repeat if necessary. If stain remains, apply a few drops of liquid detergent and a few drops of ammonia. Blot dry and rinse. If stain remains, soak in an enzyme presoak. Wash.

continued on next page



Removing Stains

STAIN	TO REMOVE
Deodorants and anti-perspirants	<p>Light stain: Treat with liquid detergent or your regular laundry detergent. Wash in hottest water safe for fabric.</p> <p>Heavy stain: Place face down on towel and treat with a paste of ammonia and all-fabric bleach. Let stand for 30 minutes. Wash in hottest water safe for fabric.</p>
Fat, grease, or oil	<p>Items soiled with vegetable or cooking oil should not be washed or dried. See vegetable/cooking oil Warning on page 3. For other types of greasy stains, use one of the methods below:</p> <ul style="list-style-type: none"> • Use pretreatment stain remover. Follow label directions. Wash in hottest water safe for fabric. • Use talcum powder to absorb as much grease as possible. Sponge with a nonflammable fabric cleaner. Rinse. Wash. • Treat with liquid detergent or rub a detergent paste on the stain. Wash using hottest water safe for fabric.
Fruit stains	<p>Fresh stains: Soak immediately in cool water. Wash. If stain remains, cover area with a paste made of all-fabric bleach, a few drops of hot water and a few drops of ammonia. Wait 15 to 30 minutes. Wash.</p> <p>Old stains: Sponge with white vinegar. Rinse. Repeat procedure for fresh stains.</p>
Grass or green vegetables	<p>Soak in warm or cold water with an enzyme presoak for at least 30 minutes, or sponge with denatured alcohol. Wash in water temperature and bleach safe for the fabric. For colored fabrics, check colorfastness before applying alcohol. For acetate, sponge with a nonflammable fabric cleaner. If stain remains, bleach with 3% hydrogen peroxide. Rinse. Rewash.</p>
Ink or ballpoint pen ink	<p>Spray stain with an aerosol hair spray or rubbing alcohol. Sponge stain continuously until all bleeding stops. Let dry. Repeat if necessary. Wash. If stain remains, bleach if safe for fabric. (India and other indelible inks are almost impossible to remove completely.)</p>
Iron or rust	<p>Colored or noncolorfast items: Apply lemon juice and salt. Place in the sun to dry. Rinse thoroughly. Repeat if necessary.</p> <p>White or colorfast items: Try a rust remover. Test first on inside seam or hem. Some rust removers are not washer safe. Follow package directions.</p>
Ketchup or tomato products	<p>Sponge immediately with a nonflammable fabric cleaner or apply a prewash soil and stain remover. Rinse. Wash. If stain remains, apply a liquid detergent to stain or soak in warm water with an enzyme presoak. Rewash.</p>
Lipstick	<p>Apply nonflammable fabric cleaner or prewash soil and stain remover. Blot with absorbent material. Repeat if necessary. Rinse. If stain still remains, rub with liquid detergent. Wash.</p>

STAIN	TO REMOVE
Meat juice, egg	Scrape off excess with a dull knife. Soak in cold or warm water with enzyme presoak at least 30 minutes, or treat stains with a nonflammable fabric cleaner. Wash.
Mildew	Wash in hottest water safe for fabric. If stain remains, soak in warm water and an all-fabric bleach for 15 to 30 minutes. Rewash. (Old mildew stains are almost impossible to remove. Mildew fungus destroys or weakens fabrics.) An alternative to bleach is to treat with salt and lemon juice and dry in direct sunlight. Rinse and rewash. Mildew may form if wet or damp laundry remains in your washer for extended periods of time. To prevent mildew, promptly dry laundry after washing.
Mustard	Treat immediately. Scrape off excess mustard. Sponge with a nonflammable fabric cleaner or a prewash soil and stain remover. Rinse. Work liquid detergent and a few drops of vinegar into stain. Rinse. If stain remains, apply 3% hydrogen peroxide. Rinse and wash.
Paint	Hand wash paint-stained items. Water base: Treat stains while still wet. (These paints cannot be removed after they have dried.) Rinse in warm water to flush out paint. Sponge with a nonflammable fabric cleaner. Rinse. Wash. Oil base: Scrape off fresh paint. Sponge with a nonflammable fabric cleaner or treat stain with recommended thinner. While stain is still wet with solvent, rub liquid detergent into it. Wash with hottest water safe for fabric.
Perspiration	Remove stains before ironing. Perspiration stains may weaken fabric. Wash or sponge stain thoroughly with detergent and warm water. If perspiration has changed the color of the fabric, use one of the following treatments: Fresh stains: Apply ammonia to stain. Rinse. Launder to remove ammonia odor. Old stains: Apply white vinegar to stain. Rinse. Launder to remove vinegar odor.
Scorch	Severe scorch cannot be removed. Wet stain with 3% hydrogen peroxide. Cover with a dry cloth and press with an iron as hot as is safe for fabric. Rinse well. Wash. OR Wet with lemon juice and spread in the sun to dry. Wash.
Soft drinks	Sponge immediately with cold water and alcohol. Heat and detergent may set stain.

Troubleshooting

Most laundering problems are easily solved if you understand the cause. Check the following list for common laundry problems and the next page for common washer problems. If you need further assistance, see page 24.

Common laundry problems

PROBLEM	CAUSE
Brown, yellow stains	<ul style="list-style-type: none"> • Chlorine staining • Iron in water heater or pipes; iron and manganese in water
Dye transfer	<ul style="list-style-type: none"> • Improper sorting • Load not immediately removed from washer after end of cycle
Gray whites, dingy colors	<ul style="list-style-type: none"> • Improper sorting • Water temperature too low • Not enough detergent • Using soap in very hard water (use detergent in hard water)
Greasy looking spots	<ul style="list-style-type: none"> • Fabric softener poured directly on clothes • Not enough detergent or dispenser not used
Lint	<ul style="list-style-type: none"> • Improper sorting • Paper or tissue in pockets • Pilling being mistaken for lint • Not enough detergent
Load too wet after spin	<ul style="list-style-type: none"> • Cold rinses • Cycle stopped before spinning is complete
Shrinking	<ul style="list-style-type: none"> • Fabric type (some knits stretch during manufacturing – laundering returns fabric to original size) • Care label directions not followed
Snags, rips, and holes	<ul style="list-style-type: none"> • Items damaged before washing • Misuse of chlorine bleach (do not pour directly on clothes); dispenser not used • Sharp items not removed from pockets; fasteners not fastened
Stiff, rough fabrics	<ul style="list-style-type: none"> • Using soap in very hard water (use detergent in hard water) • Not enough detergent • Line drying
Twisting/ Tangling	<ul style="list-style-type: none"> • Overloading • Clothes wrapped around agitator
Wrinkling	<ul style="list-style-type: none"> • Overloading (leave more room for permanent press and knits) • Load not immediately removed from washer after cycle • Warm rinse water • Cycle selection incorrect
Yellow areas (from body oils)	<ul style="list-style-type: none"> • Water temperature too low • Not enough detergent

Common washer problems

Before calling for service, check these:

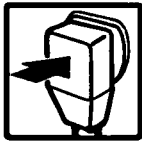

Is the power cord firmly plugged into a live outlet with proper voltage?

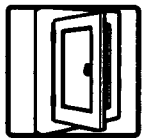

Have you blown a household fuse or tripped a circuit breaker? Has a time-delay fuse been used?



Are both the hot and cold water faucets turned on?



Are the water hoses kinked or clogged?

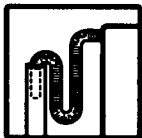

Is the drain hose lower than the water level in the washer? It must be higher.

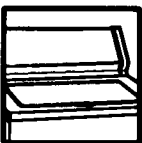

Is the lid closed?



Is the Cycle Control Knob set and pulled out?



Is the washer making noises or vibrating?

Is the wash load properly distributed around the agitator?

NOTE: Washer stops briefly during a wash cycle. These pauses are normal.

If none of these items was causing your problem, see "If You Need Assistance or Service" on page 24.

If You Need Assistance or Service

1. If you need assistance* ...

- Call the KitchenAid Consumer Assistance Center:

1-800-422-1230

One of our trained consultants can instruct you in how to obtain satisfactory operation from your appliance or, if service is necessary, recommend a qualified service company in your area.

- If you prefer, write to:
Consumer Assistance Center
KitchenAid
2000 North M-63
Benton Harbor, MI 49022-2692

2. If you need service* ...

- Call your dealer or the repair service he recommends.
- All service should be handled locally by the dealer from whom you purchased the unit or an authorized KitchenAid servicer.
- If you are unable to obtain the name of a local authorized KitchenAid servicer, call our Consumer Assistance Center telephone number (see Step 1).

3. If you are not satisfied with the action taken:

- Contact the Major Appliance Consumer Action Panel (MACAP). MACAP is a group of independent consumer experts that voices consumer views at the highest levels of the major appliance industry.
- Contact MACAP only when the dealer, authorized servicer, and KitchenAid have failed to resolve your problem.
Major Appliance Consumer Action Panel
20 North Wacker Drive
Chicago, IL 60606
- MACAP will in turn inform us of your action.

*When asking for help or service:

Please provide a detailed description of the problem, your appliance's complete model and serial numbers, and the purchase date. (See page 2.) This information will help us respond properly to your request.

Don't forget, KitchenAid offers a full line of quality home appliances.

Built-in Refrigerators	Trash Compactors	Ranges & Cooktops
Freestanding Refrigerators	Hot Water Dispensers	Microwave Ovens
50-Pound Ice Makers	Food Waste Disposers	Washers & Dryers
Dishwashers	Built-in Ovens	Mixers & Blenders

For more information on these appliances, or the one you have purchased, call our toll-free Consumer Assistance Center telephone number, **1-800-422-1230**.

KitchenAid® Washer Warranty

LENGTH OF WARRANTY:	KITCHENAID WILL PAY FOR:	KITCHENAID WILL NOT PAY FOR:
ONE YEAR FULL WARRANTY FROM DATE OF PURCHASE.	Replacement parts and repair labor costs to correct defects in materials or workmanship. Service must be provided by an authorized KitchenAid servicing outlet.	A. Service calls to: <ol style="list-style-type: none"> 1. Correct the installation of the washer. 2. Instruct you how to use the washer. 3. Replace house fuses or correct house wiring. 4. Correct house plumbing. B. Repairs when washer is used in other than normal home use. C. Damage resulting from accident, alteration, misuse, abuse, improper installation, or installation not in accordance with local electrical or plumbing codes. D. Any labor costs during the limited warranties. E. Replacement parts or repair labor costs for units operated outside the United States. F. Pickup and delivery. This product is designed to be repaired in the home. G. Repairs to parts or systems caused by unauthorized modifications made to the appliance.
SECOND YEAR LIMITED WARRANTY FROM DATE OF PURCHASE.	Replacement parts to correct defects in materials or workmanship.	
SECOND THROUGH FIFTH YEAR LIMITED WARRANTY FROM DATE OF PURCHASE.	Replacement parts for the cabinet assembly should it rust through due to defects in materials or workmanship. For all models with two or three speed motors (includes all models except the KAWL410B and the KAWE470B) replacement parts for the motor to correct defects in materials or workmanship. For solid state touch control models, replacement parts for the solid state controls if defective in materials or workmanship.	
SECOND THROUGH TENTH YEAR LIMITED WARRANTY FROM DATE OF PURCHASE.	Replacement parts for any part of the gearcase assembly to correct defects in materials or workmanship. Replacement parts for the washer outer tub should it fail to contain water due to defects in materials or workmanship.	

KITCHENAID DOES NOT ASSUME ANY RESPONSIBILITY FOR INCIDENTAL OR CONSEQUENTIAL DAMAGES. Some states do not allow the exclusion or limitation of incidental or consequential damages, so this exclusion or limitation may not apply to you. This warranty gives you specific legal rights and you may also have other rights which vary from state to state.

Outside the United States, a different warranty may apply. For details, please contact your authorized Whirlpool distributor or military exchange.

If you need service, first see the "If You Need Assistance or Service" section of this book. After checking "If You Need Assistance or Service," additional help can be found by calling our Consumer Assistance Center, **1-800-422-1230**, from anywhere in the U.S.A.

KitchenAid
Benton Harbor, Michigan, U.S.A. 49022-2692



Printed on recycled paper –
10% post consumer waste
50% recovered materials

Part No. 3946873

© 1994 KitchenAid

® Registered Trademark of KitchenAid.

Printed in U.S.A.