

This Owner's Manual is provided and hosted by [Appliance Factory Parts](#).

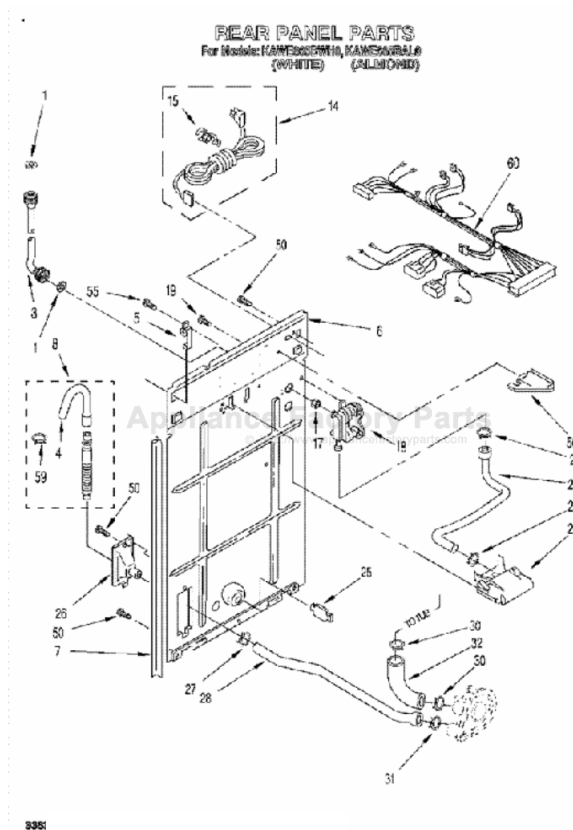

KITCHENAID KAWE665BWH0 Owner's Manual

[Shop genuine replacement parts for KITCHENAID
KAWE665BWH0](#)



[Find Your KITCHENAID Washer Parts - Select From 132 Models](#)

----- Manual continues below -----

Use and Care Guide

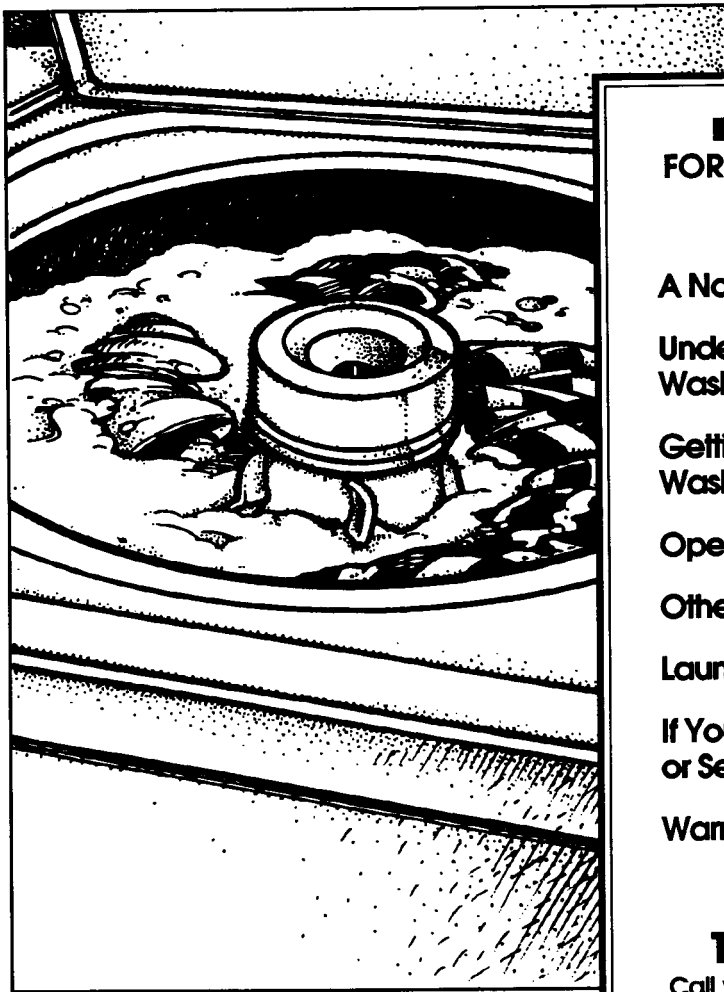

KitchenAid®
FOR THE WAY IT'S MADE.™

A Note to You	2
Understanding Washer Safety	3
Getting To Know Your Washer	4
Operating Your Washer ...	5
Other Features	11
Laundry Tips	13
If You Need Assistance or Service	25
Warranty	28

1-800-422-1230

Call with questions or comments.

KITCHENAID® Washers

Models: KAW565B KAW570B KAW577B KAW665B KAW667B

A Note to You

Thank you!

Thank you for buying a KITCHENAID® home appliance. This world-class product is the result of years of engineering experience. To ensure reliable, trouble-free operation, please read and follow this Use and Care Guide. In it you will find valuable information to help you safely operate and maintain your appliance.

Also, please complete and mail your Product Registration Card.

Your safety is important to us.

This guide contains safety symbols and statements. Please pay special attention to these symbols and follow any instructions given. Here is a brief explanation of the use of each symbol.

WARNING

This symbol will help alert you to such dangers as personal injury, burns, fire and electrical shock.

CAUTION

This symbol will help you avoid actions which could cause product damage (scratches, dents, etc.) and damage to your personal property.

Our Consumer Assistance Center telephone number, 1-800-422-1230, is toll-free 24 hours a day.

If you have a question concerning your home appliance's operation, or if you need service, first see "If You Need Assistance or Service" on page 25. If you need further help, call our toll-free Consumer Assistance Center telephone number. When calling, you will need to know your appliance's complete model number and serial number. You can find this information on the model and serial number plate (see diagram on page 4). Record these numbers and purchase information below. You will need this information if you require service. Keep this book and the sales slip together in a safe place for future reference.

NOTE: You must provide proof of purchase or installation date for in-warranty service.

Model Number _____ **Builder/Dealer Name** _____
Serial Number _____ **Address** _____
Date Installed _____ **Phone** _____

IMPORTANT SAFETY INSTRUCTIONS

WARNING

To reduce the risk of fire, electrical shock, or injury when using your washer, follow basic precautions including the following:

- Read all instructions before using your washer.
 - Do not machine wash or machine dry items cleaned, washed, soaked in, or spotted with wax, paint, gasoline, oil, or other flammable fluids. The fumes can create a fire hazard or explosion. Always hand wash and line dry items containing these materials.
 - Flammable fluids (dry-cleaning solvents, kerosene, gasoline, etc.) should not be used or stored in or near your washer. Do not add flammable fluids to your wash water. These substances give off vapors that can create a fire hazard or explosion.
 - Do not allow children to operate, play with, or crawl on or inside your washer. Supervise children closely when your washer is used near them.
 - Before your washer is removed from service or discarded, remove the lid to prevent accidental entrapment.
 - After starting a cycle, do not reach into the basket unless the Cycle Control Knob is pushed in and all motion stops.
 - Do not tamper with the controls.
 - If your hot water has not been used recently (usually 2 weeks or longer), hydrogen gases may build up in your water heater and your hot water pipes. **HYDROGEN GAS IS EXPLOSIVE.** To prevent injury or damage, before using your washer, turn on all hot water faucets and allow water to run for several minutes. This will allow gases to escape. Do not smoke or use any open flame near your faucet while it is open.
- Please ...
- Have only a qualified person install, repair, or replace parts on washer.
 - Maintain washer properly.
 - Protect washer from the weather and keep it where the temperature will not fall below freezing.
 - Install and level washer on a floor that can support the weight.*
 - Connect washer to the correct 3-prong outlet, electrical supply, water supply, and drain.*
 - Ground washer properly.*
- *See the Installation Instructions.

Understanding your responsibilities

- Store detergent, laundry aids and other materials in a cool, dry place where children cannot reach them (in a locked cabinet if possible).
- Read and follow instructions on packages of detergent and laundry aids, especially warnings and precautions.
- Do not use chlorine bleach and ammonia or acids (such as vinegar or rust remover) in the same wash. Hazardous fumes can form.
- Do not wash or dry items that are soiled with vegetable or cooking oil. These items may contain some oil after laundering. Due to the remaining oil, the fabric may smoke or catch fire by itself.
- Unplug power supply cord before attempting to service your washer.
- Do not machine wash fiberglass materials. Small particles can stick to the fabrics washed in following loads and cause skin irritation.

—SAVE THESE INSTRUCTIONS—

Getting to Know Your Washer

The parts and features of your washer are illustrated in this section. Become familiar with all parts and features before using your washer.

NOTES:

- The drawings in this book may vary from your washer model. They are designed to show the different features of all models covered by this book. Your model may not include all features.
- Page references are included next to some features. Refer to those pages for more information about the features.

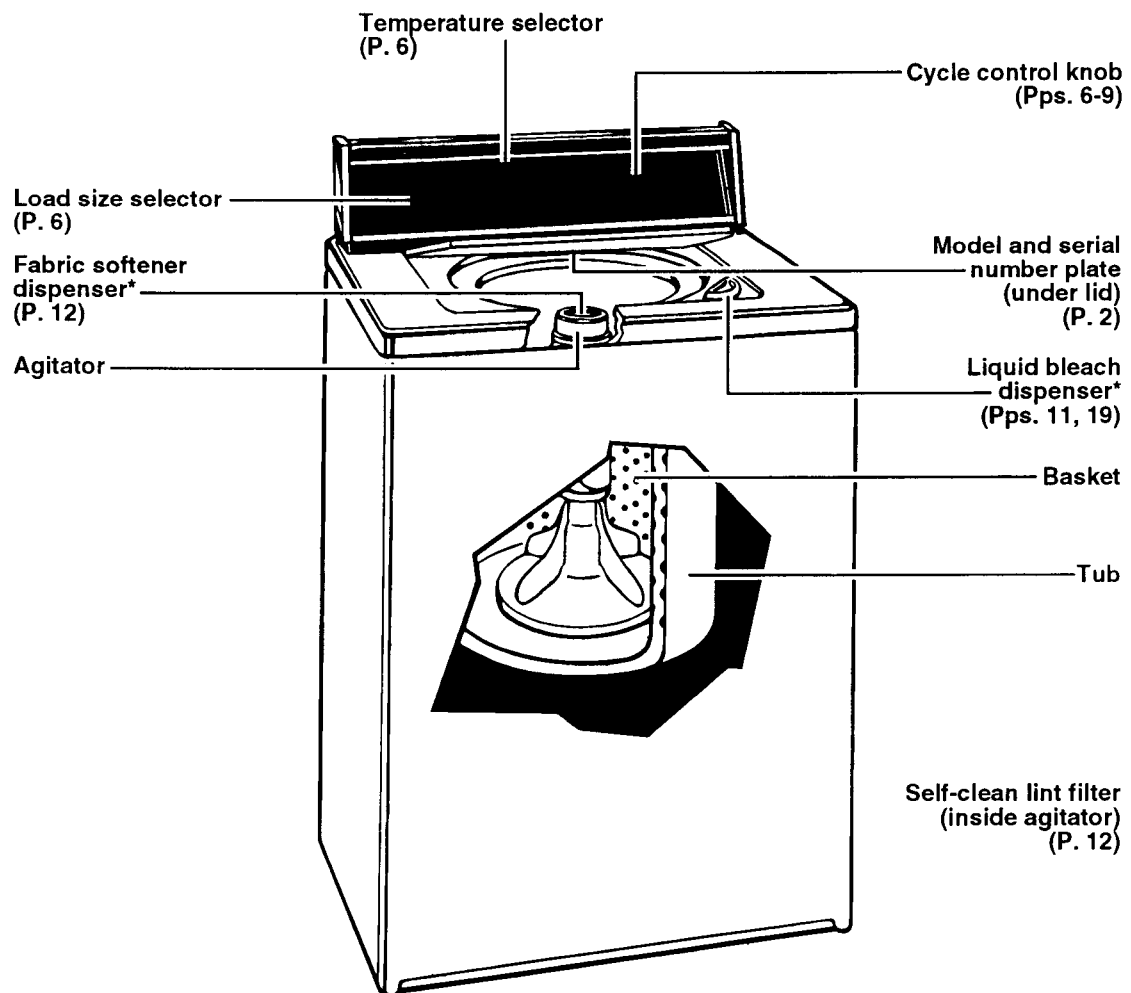

*Available on some models

Operating Your Washer

This section tells you how to operate your washer. Operating your washer properly enables you to obtain the best possible results.

IN THIS SECTION

Before starting your washer	5	Selecting a cycle and setting	6
Starting or stopping your washer ...	5	Using rinse and spin	9
Selecting a load size	6	Using drain and spin	9
Selecting wash-rinse temperatures	6	What happens in each cycle	10

Before starting your washer

Add measured detergent. Then place a sorted load in the washer before starting. See page 13 for additional "Before you wash" information.

NOTE: If your washer has a Consumer Buy Guide, remove it and place it in your Use and Care Guide.

Starting or stopping your washer

Starting your washer

1. Select a load size and water temperature.
2. Push in and turn the Cycle Control Knob clockwise. Stop when the indicator on the knob's outer ring points to the setting in the wash cycle you want. The settings indicate soil level.
3. Pull out the Cycle Control Knob.

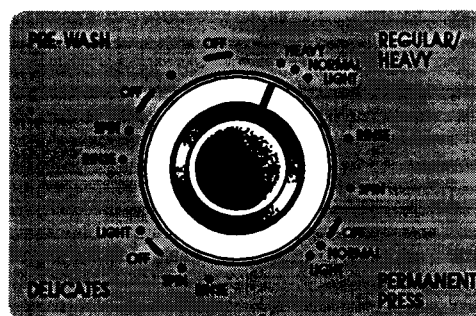

Cycles may vary with model

Stopping and restarting your washer

- To stop the washer at any time, push in the Cycle Control Knob.
- To restart the washer, close the lid (if necessary) and pull out the Cycle Control Knob.

Selecting a load size

Position the Load Size Selector at the setting that corresponds to the size load you want to wash. Select a load size based on the size of load and the fabric you are washing. See page 14 for additional loading information.

To change the load size setting after the washer has started to fill, move the Selector to the desired new setting.

NOTE: If you select the largest load size, the washer fills to the highest water level (near the top of the basket, not to the top of the agitator).

- Items should move freely in the washer. Do not overload the machine or select a load size that is too small for the wash load.
- Use a large load size setting for best results with permanent press clothes.
- Reduce wash time when using a small load size setting. Loads with only a few small items need less wash time.

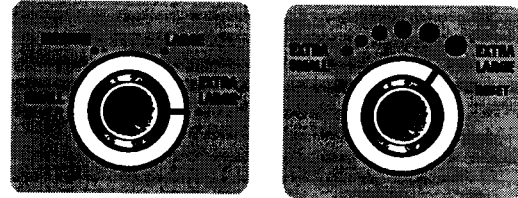

Settings may vary with model

If your selector has RESET

To change the water level selection **after the washer starts filling**, first move the Selector to RESET, then to the new water level.

Selecting wash-rinse temperatures

Match the water temperature to the type of fabric and soils being washed. The top temperature is the wash water and the bottom temperature is the rinse water.

See the "Water usage guide" on page 18 for more information.

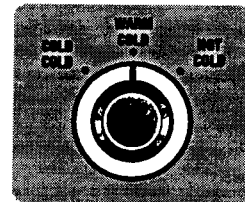

Selecting a cycle and setting

You will find information you need to help you make correct cycle selections in this section.

- Pages 7-9: Use the information on these pages to guide you when selecting a wash cycle and time.
- Page 10: Use this page to help you understand what happens during a wash cycle.

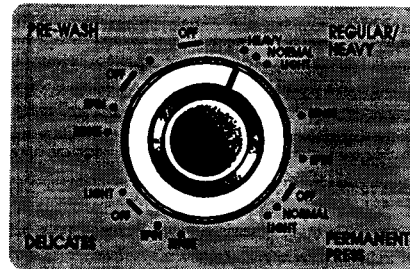

Cycles may vary with model

Regular/Heavy cycle

The Regular/Heavy cycle features high spin speeds designed to shorten drying time.

- Use HEAVY to clean large loads of sturdily constructed cotton and linen fabrics that are heavily soiled.
- Use NORMAL to clean sturdily constructed cotton and linen fabrics that are moderately soiled.
- Use LIGHT to clean sturdily constructed cotton and linen fabrics that are lightly soiled.



Regular/Heavy cycle

Permanent Press cycle

The Permanent Press cycle features a cool-down rinse and low spin speeds to reduce wrinkling.

- Use NORMAL to clean permanent press and some synthetic fabrics that are moderately soiled.
- Use LIGHT to clean permanent press and some synthetics that are lightly soiled.

NOTE: The washer pauses briefly during the wash cycle. This is normal for washer operation.

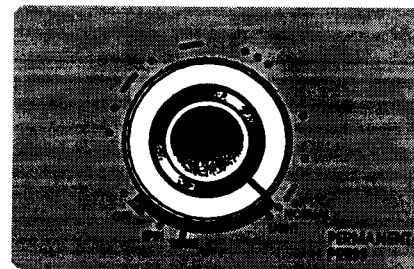

Permanent Press cycle

Delicates cycle

The Delicates cycle features a brief wash cycle. Low spin speeds reduce wrinkling.

- Use LIGHT to clean lightly to moderately soiled delicate items and washable knits.

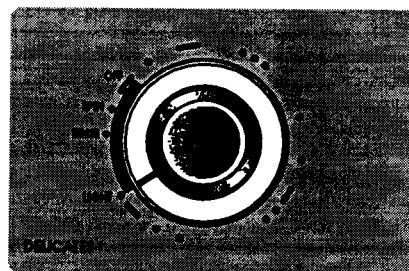

Delicates cycle

Pre-Wash cycle

The Pre-Wash cycle features a brief period of agitation and high spin speeds to help remove heavy soils and stains that need pretreatment.

- Use warm water for prewashing stained laundry. (Hot water can set stains.) See pages 15-17 for stain removal information.
- After the Pre-Wash cycle ends, add detergent and set a new wash cycle.

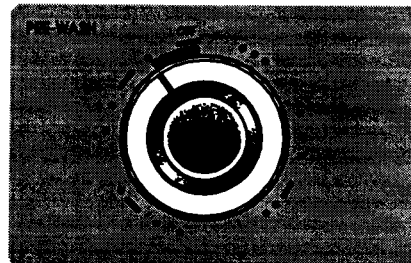

Pre-Wash cycle

Soak/Pre-Wash cycle

(on some models)

The Soak cycle features brief periods of agitation and soak time to help remove heavy soils and stains that need pretreatment.

- Use warm water when soaking laundry. (Hot water can set stains.) See pages 15-17 for stain removal information.
- Use the amount of detergent or presoak additive recommended by manufacturer.
- The Soak cycle automatically advances into Pre-Wash.

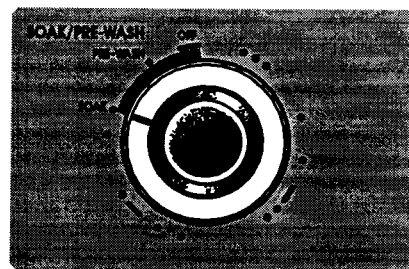

Soak/Pre-Wash cycle

Extra Wash cycle

(on some models)

Extra Wash automatically prewashes the laundry and advances into the Regular/Heavy cycle. (The washer does not need to be reset after the Extra Wash cycle.) Use this cycle when washing heavily soiled loads that need maximum soil removal.

- For proper cleaning, use double the amount of detergent recommended for a wash cycle.

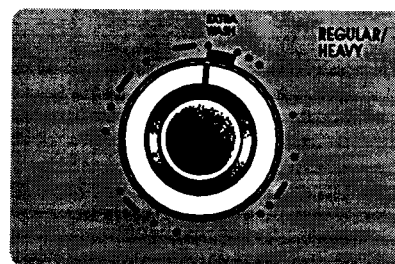

Extra Wash cycle

NOTE: The machine pauses during Extra Wash. This is normal for washer operation.

Using rinse and spin

When using extra detergent for heavily soiled clothes, or washing special-care items, you may want an extra rinse and spin.

1. Push the Cycle Control Knob in and turn clockwise to RINSE, as illustrated.
2. Pull the Cycle Control Knob out. The washer fills to selected load size, agitates, drains, and spins.

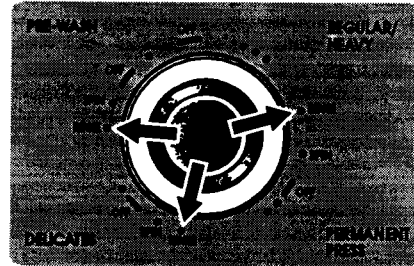

Using drain and spin

A drain and spin may help shorten drying times for some heavy fabrics or special-care items by removing excess water.

1. Push the Cycle Control Knob in and turn clockwise to SPIN, as illustrated.
2. Pull the Cycle Control Knob out. The washer drains, then spins.



What happens in each cycle

When the Cycle Control Knob is turned to a setting and pulled out, the washer fills (to the selected load size) before agitation and timing start. The washer will begin agitating immediately after filling; agitation can occur with the washer lid up or down.

After agitation starts, the Cycle Control Knob turns clockwise until it points to OFF and the cycle ends.

The washer pauses briefly throughout each cycle. These pauses are normal for washer operation.

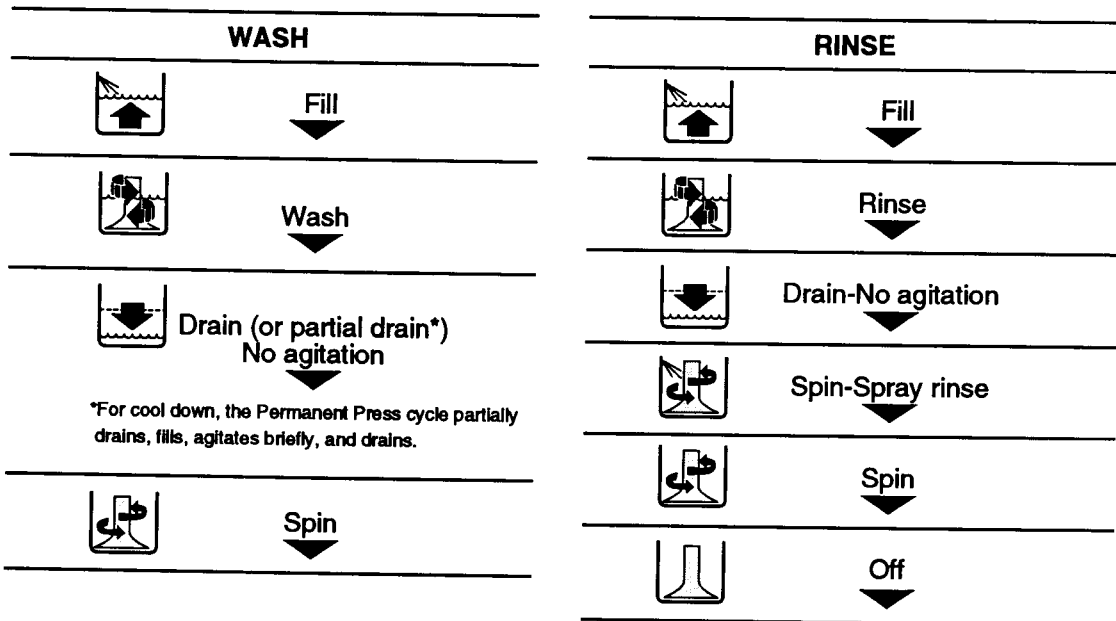

Other Features

Your washer may have some of the following features. Understanding the use of the features on your machine will help you efficiently use your washer.

IN THIS SECTION

Using the Extra Rinse option	11	Using the fabric softener dispenser	12
Using the chlorine bleach dispenser	11	About your lint filter	12

Using the Extra Rinse option

You can select an extra rinse in the Regular/Heavy cycle.

- Before the cycle starts, select Extra Rinse ON. The washer automatically adds an extra rinse and spin to the cycle.
- If no extra rinse and spin are desired, select Extra Rinse OFF.

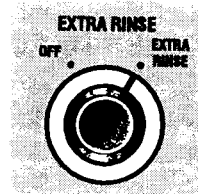

Using the chlorine bleach dispenser

(on some models)

See page 19 if you do not have a chlorine bleach dispenser.

Always measure liquid chlorine bleach. Do not guess. Never use more than 1 cup (250 mL) for a full load. Use less with lower water level settings. Follow manufacturer's directions for safe use. Use a cup with a pouring spout to avoid spilling.

1. Load the washer.
2. Pour measured chlorine bleach carefully into dispenser. Do not let bleach splash, drip or run down into washer basket. Undiluted bleach will damage any fabric it touches.
3. Start the washer. Bleach will be diluted automatically during the wash part of the cycle.

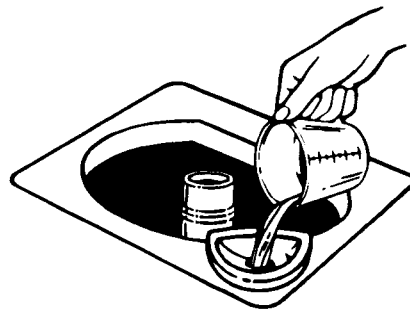

NOTE: Do not use this dispenser to add powdered chlorine or all-fabric bleach to your wash load. The dispenser is for liquid chlorine bleach only.

Using the fabric softener dispenser

(on some models)

If the top of the agitator has a pouring well with a cross-bar at the bottom, your model has a fabric softener dispenser. See page 20 if you do not have a fabric softener dispenser.

1. Add detergent and load the basket.
2. Pour liquid fabric softener into the dispenser using the amount recommended on the package. Avoid dripping or spilling any fabric softener on the load.
3. Dilute fabric softener with warm water. Fill dispenser with warm water until liquid reaches the cross-bar in the pouring well.
4. Start the washer. Diluted fabric softener will be added to the load during the first rinse.

NOTE: Do not stop the washer before the final rinse begins. Staining can occur.

Flush dispenser periodically with warm water.

- To remove the dispenser, grasp the top of the dispenser with both hands. Squeeze and push upward with thumbs to remove.
- Clean dispenser by holding under water faucet. Replace after cleaning.

NOTE: Do not wash clothes with this dispenser removed. Do not add detergent or bleach to dispenser. The dispenser is for fabric softener use only.

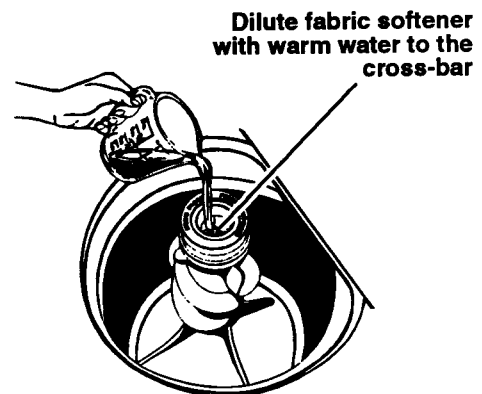

Add fabric softener and water



Clean the dispenser

About your lint filter

Your washer has a self-cleaning lint filter (requires no cleaning by you). The lint filter at the bottom of the washer basket cleans itself. During agitation, wash and rinse water pass over the filter, separating the lint from the water. The lint is then spun away from the filter and out of the system during the spin part of the cycle.

If your washer drains into a tub, remove any lint collected in the tub or strainer.

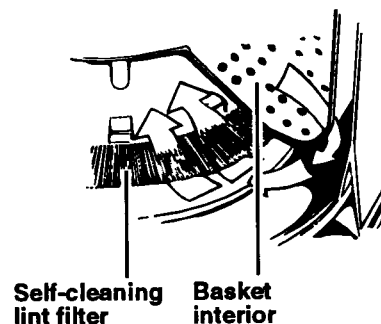

Laundry Tips

This section reviews proper laundering techniques, gives you additional washing information, and discusses solutions to common laundering problems.

IN THIS SECTION

Before you wash	13	Solving laundering problems	22
Removing stains	15	Saving energy	23
Water usage guide	18	Caring for your washer	23
Using laundry aids	19	Care during periods of non-use	24
Washing special-care items	20		

Before you wash

Preparing clothes for washing

- Close zippers, snaps, and hooks to avoid snagging other items. Remove pins, buckles, and other hard objects to avoid scratching the washer interior. Remove unwashable trim and ornaments.



- Empty pockets and turn them inside out.
- Turn down cuffs and brush away lint and dirt.
- Turn synthetic knits inside out to avoid pilling.
- Tie strings and sashes so they will not tangle.
- Mend tears, loose hems and seams.
- Treat spots and stains. (See pages 15-17 for pretreatment and stain removal information.)
- Stained or wet garments should be washed promptly for best results.

Sorting

- Separate heavily soiled items from lightly soiled ones even if they would normally be washed together. Separate lint givers (towels, chenille) from lint takers (corduroy, synthetics, permanent press). When possible, turn lint givers inside out.
- Separate dark from light colors, colorfast from noncolorfast.
- Sort by fabric and construction (sturdy cottons, knits, delicate items).



Loading

- Drop items into washer loosely. Fill to the top of the basket, but do not pack or wrap items around the agitator. Items should move easily through wash water for best cleaning and wrinkle-free results. Watch for rollover. Items should sink and reappear later.
- Load washer properly. Overloading or packing can:
 - cause poor cleaning.
 - increase wrinkling.
 - create excessive lint.
 - wear out items faster (because of pilling).

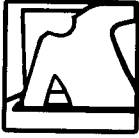

- Load by the amount of space items take up, not by their weight.
- Mix large and small items in each load.



- Load evenly to maintain washer balance. An off-balance load can make the machine vibrate during spin. To reduce wrinkling, permanent press and synthetic knits should have more room to move in the water than heavy items (towels, jeans).

Loading suggestions:

For these suggested full-sized loads, use the highest load size setting.

EXTRA LARGE CAPACITY WASHERS			
Heavy Work Clothes 3 pair pants 3 shirts 4 pair jeans 1 coverall 1 overall	Towels 10 bath towels 10 hand towels 14 wash cloths 1 bathmat	Permanent Press 2 double or 1 king size sheet 1 tablecloth 1 dress 1 blouse 2 slacks 3 shirts 2 pillowcases	Mixed Load 3 double sheets 4 pillowcases 8 T-shirts 6 pair shorts 2 shirts 2 blouses 8 handkerchiefs
Knits 3 slacks 3 blouses 6 shirts 4 tops 4 dresses	Delicates 3 camisoles 1 quilted robe 4 slips 4 panties 2 bras 2 nighties 1 baby's dress		

Removing stains

Stained, heavily soiled or greasy items may need to be prewashed or soaked for best results. Soaking helps remove protein-type stains like blood, milk, or grass. Prewashing helps loosen soil before washing.

Prewashing or soaking

Use warm water for soaking or prewashing stained laundry. Hot water can set stains.

Stain removal rules

- Most stains are easier to remove when they are fresh. Old or set stains may not come out. Follow package directions for pretreatment products.
- Before treating any stain, find out ...
 1. What kind of stain it is.
 2. What kind of fabric it is and if it is colorfast. (Check label.)

3. How old the stain is. (Washing and drying can set some stains.)

- Start with cold or warm water. Hot water can set some stains.
- When bleach is recommended, use a bleach that is safe for the fabric. Dilute chlorine bleach.
- Test stain removers on an inside seam or hidden corner of the item to see if the color is removed.
- Put the stained area face down on a paper towel or white cloth. Apply the stain remover to the back of the stain. This can force the stain off the fabric instead of through it.
- Meat tenderizer or enzyme presoaks help break down some protein stains so they are easier to remove.

Stain removal guide

STAIN	TO REMOVE
Alcoholic beverage	These stains turn brown with age, so treat immediately. Sponge or soak fresh stains with cold water. Wash. If stain remains, soak 15 minutes in a solution of lukewarm water, liquid detergent and a few drops of white vinegar. Rinse. Wash.
Blood	Rinse immediately or soak in cold water with enzyme presoak for 30 minutes or longer. Rinse. Rub detergent into any remaining stains. Rinse. If stain remains, put a few drops of 3% hydrogen peroxide on stain for 3-5 minutes. Rinse thoroughly. Wash.
Chewing gum	Use ice to make gum hard. Scrape off what you can. Sponge with a nonflammable fabric cleaner. Let dry. Wash.
Chocolate or coffee	Sponge immediately with a nonflammable fabric cleaner or apply a prewash soil and stain remover. Rinse. Wash. If stain remains, apply a liquid detergent to stain or soak in warm water with an enzyme presoak. Rewash.
Crayon and candle wax	Scrape off excess with a dull knife. Place fabric between two blotters or facial tissue. Press with warm iron. Remove color stain with nonflammable fabric cleaner. Hand wash until stain is gone. If full load is crayon stained, take to cleaners or coin-operated dry cleaning machine.
Cream, milk or ice cream	Sponge with a nonflammable fabric cleaner, or a prewash soil and stain remover. Rinse. Wash. Repeat if necessary. If stain remains, apply a few drops of liquid detergent and a few drops of ammonia. Blot dry and rinse. If stain remains, soak in an enzyme presoak. Wash.



Laundry Tips

STAIN	TO REMOVE
Deodorants and anti-perspirants	Light stain: Treat with liquid detergent or your regular laundry detergent. Wash in hottest water safe for fabric. Heavy stain: Place face down on towel and treat with a paste of ammonia and all-fabric bleach. Let stand for 30 minutes. Wash in hottest water safe for fabric.
Fat, grease or oil	Items soiled with vegetable or cooking oil should not be washed or dried. See vegetable/cooking oil Warning on page 3. For other types of greasy stains, use one of the methods below: <ul style="list-style-type: none">• Use pretreatment stain remover. Follow label directions. Wash in hottest water safe for fabric.• Use talcum powder to absorb as much grease as possible. Sponge with a nonflammable fabric cleaner. Rinse. Wash.• Treat with liquid detergent or rub a detergent paste on the stain. Wash using hottest water safe for fabric.
Fruit stains	Fresh stains: Soak immediately in cool water. Wash. If stain remains, cover area with a paste made of all-fabric bleach, a few drops of hot water and a few drops of ammonia. Wait 15 to 30 minutes. Wash. Old stains: Sponge with white vinegar. Rinse. Repeat procedure for fresh stains.
Grass or green vegetables	Soak in warm or cold water with an enzyme presoak for at least 30 minutes, or sponge with denatured alcohol. Wash in water temperature and bleach safe for the fabric. For colored fabrics, check colorfastness before applying alcohol. For acetate, sponge with a nonflammable fabric cleaner. If stain remains, bleach with 3% hydrogen peroxide. Rinse. Rewash.
Ink or ballpoint pen ink	Spray stain with an aerosol hair spray or rubbing alcohol. Sponge stain continuously until all bleeding stops. Let dry. Repeat if necessary. Wash. If stain remains, bleach if safe for fabric. (India and other indelible inks are almost impossible to remove completely.)
Iron or rust	Colored or noncolorfast items: Apply lemon juice and salt. Place in the sun to dry. Rinse thoroughly. Repeat if necessary. White or colorfast items: Try a rust remover. Test first on inside seam or hem. Some rust removers are not washer safe. Follow package directions.
Ketchup or tomato products	Sponge immediately with a nonflammable fabric cleaner or apply a prewash soil and stain remover. Rinse. Wash. If stain remains, apply a liquid detergent to stain or soak in warm water with an enzyme presoak. Rewash.
Lipstick	Apply nonflammable fabric cleaner or prewash soil and stain remover. Blot with absorbent material. Repeat if necessary. Rinse. If stain still remains, rub with liquid detergent. Wash.
Meat juice, egg	Scrape off excess with a dull knife. Soak in cold or warm water with enzyme presoak at least 30 minutes, or treat stains with a nonflammable fabric cleaner. Wash.

STAIN	TO REMOVE
Mildew	Wash in hottest water safe for fabric. If stain remains, soak in warm water and an all-fabric bleach for 15 to 30 minutes. Rewash. (Old mildew stains are almost impossible to remove. Mildew fungus destroys or weakens fabrics.) An alternative to bleach is to treat with salt and lemon juice and dry in direct sunlight. Rinse and rewash. Mildew may form if wet or damp laundry remains in your washer for extended periods of time. To prevent mildew, promptly dry laundry after washing.
Mustard	Treat immediately. Scrape off excess mustard. Sponge with a nonflammable fabric cleaner or a prewash soil and stain remover. Rinse. Work liquid detergent and a few drops of vinegar into stain. Rinse. If stain remains, apply 3% hydrogen peroxide. Rinse and wash.
Paint	Hand wash paint-stained items. Water base: Treat stains while still wet. (These paints cannot be removed after they have dried.) Rinse in warm water to flush out paint. Sponge with a nonflammable fabric cleaner. Rinse. Wash. Oil base: Scrape off fresh paint. Sponge with a nonflammable fabric cleaner or treat stain with recommended thinner. While stain is still wet with solvent, rub liquid detergent into it. Wash with hottest water safe for fabric.
Perspiration	Remove stains before ironing. Perspiration stains may weaken fabric. Wash or sponge stain thoroughly with detergent and warm water. If perspiration has changed the color of the fabric, use one of the following treatments: Fresh stains: Apply ammonia to stain. Rinse. Launder to remove ammonia odor. Old stains: Apply white vinegar to stain. Rinse. Launder to remove vinegar odor.
Scorch	Severe scorch cannot be removed. Wet stain with 3% hydrogen peroxide. Cover with a dry cloth and press with an iron as hot as is safe for fabric. Rinse well. Wash. OR Wet with lemon juice and spread in the sun to dry. Wash.
Soft drinks	Sponge immediately with cold water and alcohol. Heat and detergent may set stain.



Water usage guide

Water temperature

WASH	RINSE	USE FOR	COMMENTS
HOT 130°F (54°C) or above	COLD	<ul style="list-style-type: none"> • Heavy soils • Work clothes • Sturdy whites and colorfast pastels • Diapers 	<ul style="list-style-type: none"> • Gives best cleaning for heavy soils. • Removes oils, perspiration, greasy soils and stains. • Prevents graying and yellowing.
WARM 90°-110°F (32°-44°C)	COLD	<ul style="list-style-type: none"> • Light and moderate soils • Dark or noncolorfast colors • Moderately soiled permanent press • Nylons, polyesters, acrylics, silks, woolens • Knits and delicate fabrics • Prewash, soak 	<ul style="list-style-type: none"> • Safe for most fabric finishes. • Less fading and dye bleeding. • Reduces wrinkling.
COLD 70°-90°F (21°-32°C)	COLD	<ul style="list-style-type: none"> • Very lightly soiled items • Moderately soiled items if extra detergent is added • Extra sensitive colors (noncolorfast) • Rinsing, for all fabrics 	<ul style="list-style-type: none"> • Saves hot water. • Less effective cleaning than hot or warm water. • Use longest wash time in cycle selected. • Use liquid detergent, or dissolve powdered detergent in warm water before adding to cold wash water. • Pretreat spots, stains and heavy or greasy soils.

To check your hot water temperature with a candy or cooking thermometer:

1. Fill a pan with the hottest water available from the faucet that will fill your washer.
2. Place a candy or cooking thermometer in water to check the temperature.

If you do not have a faucet at your wash site, collect water from the faucet closest to your washer.

NOTE: In wash-water temperatures colder than 70°F (21°C):

- Detergents do not dissolve well.
- Soils are difficult to remove.
- Some fabrics will retain wear wrinkles and may have increased pilling.

Water hardness

Many poor washing results can be traced to wash-water hardness. To check your water hardness:

- City water—ask your city water company.
- Well water—call your Cooperative Extension Service.

Ask for the mineral content in grains-per-gallon or parts-per-million. If your water is 9 or more grains-per-gallon or more than 153 parts-per-million:

- Consider installing a water softener.
- Use more detergent.
- Use a packaged water conditioner.
- Do not use soap.

Using laundry aids

Follow package instructions when using laundry aids. (See "Removing Stains" on pages 15-17 for more information.)

WARNING

Fire or Explosion Hazard

- Store flammable solvents or liquids away from your washer.
- Dry cleaning solvents or fluids should not be put directly into your washer.
- Items treated with solvents should be rinsed and air dried before washing in your washer.

The fumes from these substances can create a fire hazard or explosion.

Personal Injury Hazard

- Never use chlorine bleach with ammonia or acids. Hazardous fumes can form.
- Keep stain removal products out of the reach of children ... preferably in a locked cabinet.

All-fabric bleach

- Powdered or liquid all-fabric bleach may be used on all types of fabrics.
- Do not use all-fabric bleach in the bleach dispenser because it may clog.

Chlorine bleach

- Use bleach dispenser if your machine has one. (See page 11.)
- If your washer does not have a bleach dispenser:
 1. Let the washer fill and begin agitating the load.
 2. Measure bleach. Never use more than 1 cup (250 mL) for a full load. Dilute measured bleach in 1 quart (1 L) of water.

3. Add bleach to wash cycle so it can be removed in the rinse cycle. Pour bleach around agitator, not directly on load.

- Follow directions on care labels. Do not use chlorine bleach on wool, silk, spandex, acetates or some flame-retardant fabrics.
- When soaking with chlorine bleach, add detergent to soak water.

NOTE: Undiluted bleach will damage any fabric it touches. The damage appears as rips, holes, tears or color loss and may not show up until several washings later.

Detergent

- Using too little detergent is a common cause of laundry problems. Follow manufacturer's directions. Measure accurately, especially when using ultra detergents. Package directions are usually based on:
 - moderate water hardness (4-6 grains)
 - lightly soiled items
 - normal wash loads.
- Use more detergent for:
 - hard water
 - cooler wash water
 - full loads
 - heavily soiled items.
- Do not judge the amount of detergent to use by the amount of suds in the machine. Low sudsing detergents do not create as many suds as normal sudsing detergents.
- If the recommended amount of normal sudsing detergent creates too many suds or suds are present in the rinse water, try a low sudsing detergent.

continued on next page

Fabric softeners

- Use fabric softener dispenser if your washer has one. (See page 12.)
- If your washer does not have a fabric softener dispenser, add diluted fabric softener only in the final rinse.
- Always dilute fabric softeners with $\frac{1}{2}$ to 1 cup (125 to 250 mL) warm water. Undiluted fabric softener can stain fabrics.
- Fabric softeners should not be mixed with other laundry products because greasy stains may form. If stains form, remove by wetting the stain and rubbing with liquid detergent or a bar of soap. Rewash the stained item.
- Too much fabric softener can make some items (diapers and towels) nonabsorbent. If this happens, use less fabric softener or do not use it every time.

Washing special-care items

Most garments and household textiles have care labels with laundering instructions. Always follow label directions when they are available. General washing instructions for some special washables are included in this section.

<p>Blankets, electric and woolen</p>	<p>Pretreat spots and stains. Select water temperature, cycle, and time according to the type of blanket being washed. Two rinses may be necessary. If manufacturer recommends machine washing:</p> <ol style="list-style-type: none"> 1. Measure blanket before washing. 2. Add mild detergent to washer. Fill and agitate briefly to dissolve detergent. 3. Stop washer. Load blanket evenly around agitator. Soak 10 to 15 minutes. 4. Set Cycle Control Knob to Drain and Spin. Start washer. Spin 1 to 2 minutes. 5. Fill washer for final rinse. Stop washer. Allow to soak. 6. Set Cycle Control Knob to Drain and Spin. Start washer. Allow washer to finish cycle. 7. Lay blanket on flat surface and block by gently stretching to original measurement. Woolens tend to shrink more the first time they are washed. This is normal.
<p>Curtains, drapes, slipcovers</p>	<p>Wash small loads. Crowding will cause wrinkling.</p> <ol style="list-style-type: none"> 1. Shake or vacuum to remove loose dirt. 2. Wash following manufacturer's instructions. <p>NOTE:</p> <ul style="list-style-type: none"> • Sun-damaged curtains and draperies will tear whether hand or machine washed. • Replace slipcovers while still slightly damp. They will dry to fit tightly.

<p>Diapers</p>	<p>When using chlorine bleach for soaking, add detergent to load. Avoid overuse of fabric softeners. Absorbency will be reduced.</p> <ol style="list-style-type: none"> 1. Rinse immediately. Soak in a solution of lukewarm water and a small amount of detergent until you are ready to wash them. You may wish to use bleach or a special soaking product when soaking. 2. Spin excess water from diapers before washing. 3. Wash diapers as you would wash white cottons and linens.
<p>Elastic, spandex</p>	<p>Elastic picks up oil from the body. Oil can damage elastic. Wash often to help reduce the damage. Use warm water and sufficient detergent to remove oils.</p>
<p>Flame-retardant clothing</p>	<p>Items will be clearly labeled as flame-retardant. Follow manufacturer's instructions to retain flame retardant qualities.</p>
<p>Fiberglass materials</p>	<p>Do not wash fiberglass materials in your washer. Glass particles could stick to the next load and cause skin irritation.</p>
<p>Knits</p>	<p>Knits are comfortable to wear because they stretch. However, this means that knits are more likely to be stretched and damaged when washed (especially bulky knits). Knits made of synthetic fabrics such as polyester, nylon, and acrylic tend to keep their original shape more than a knit made of cotton or ramie.</p> <ol style="list-style-type: none"> 1. Close zippers, fasten hooks and eyes to prevent snagging. 2. Wash small loads to reduce pilling and lint.
<p>Pillows, stuffed toys</p>	<p>Washing feather pillows is not recommended unless they are dryer dried.</p> <ol style="list-style-type: none"> 1. Add detergent, then partially fill washer with water; agitate until detergent is dissolved. 2. Place two pillows on opposite sides of the agitator to balance the load. 3. Allow washer to fill completely and continue through the cycle. 4. Stop the washer occasionally to press air from item(s) being washed.
<p>Plastic, rubber items</p>	<p>Treat as delicate items. Wash in warm water. Wash small items in a mesh bag.</p>
<p>Quilts, bedspreads</p>	<p>Do not wash cotton-filled comforters unless they are quilted or stitched; tucked cotton batting tends to slip and become lumpy.</p>
<p>Scatter rugs</p>	<ol style="list-style-type: none"> 1. Shake or vacuum to remove loose dirt. 2. Wash more than one small rug at a time. If you wash only one rug, add bath towels to balance the load. A larger rug should be distributed around the agitator to balance the load.
<p>Snowsuits, jackets, etc.</p>	<ol style="list-style-type: none"> 1. Wash only one or two items at a time. Load evenly around the agitator. 2. Stop the washer occasionally to press air from item(s) being washed. 3. Two rinses may be necessary.

Solving laundering problems

Most laundering problems are easily solved if you understand the cause. Check the following list for problems you may have and possible causes. If you need additional help, check the "Assistance or Service" section of this book.

PROBLEM	CAUSE
Brown, yellow stains	<ul style="list-style-type: none"> • Chlorine staining • Iron in water heater or pipes • Iron and manganese in water
Dye transfer	<ul style="list-style-type: none"> • Improper sorting • Load not immediately removed from washer after end of cycle
Gray whites, dingy colors	<ul style="list-style-type: none"> • Improper sorting • Water temperature too low • Not enough detergent • Using soap in very hard water (use detergent if you have hard water)
Greasy looking spots	<ul style="list-style-type: none"> • Undiluted fabric softener or fabric softener poured directly on load • Fabric softener in wash water • Not enough detergent
Lint	<ul style="list-style-type: none"> • Improper sorting • Paper or tissue in pockets • Pilling being mistaken for lint • Overloading • Not enough detergent
Load too wet after spin	<ul style="list-style-type: none"> • Cold rinses • Lid is opened before spinning is completed
Shrinking	<ul style="list-style-type: none"> • Fabric type (some knits stretch during manufacturing—laundering returns fabric to original size) • Care label directions not followed
Snags, rips, holes	<ul style="list-style-type: none"> • Items damaged before washing • Misuse of chlorine bleach • Sharp articles not removed from pockets • Overloading • Fasteners not fastened
Stiff, rough fabrics (usually cottons)	<ul style="list-style-type: none"> • Using soap in very hard water (use detergent if you have hard water) • Not enough detergent • Line drying
Twisting, tangling	<ul style="list-style-type: none"> • Overloading • Improper loading (do not wrap large items around agitator)
Wrinkling	<ul style="list-style-type: none"> • Overloading • Load not immediately removed from washer after end of cycle • Improper rinse temperature • Cycle selection is incorrect (based on fabric type)
Yellow areas (from body oils)	<ul style="list-style-type: none"> • Water temperature too low • Not enough detergent

Saving energy

- Use warm or cold wash water for most loads. Use hot water only when washing heavy, greasy soils or whites.
 - Use cold rinses.
 - Wash full loads.
 - Use lower water levels when washing small loads.
 - Avoid rewashing. Use enough detergent; pretreat stains or heavy soils; do not overload; use the cycles and wash times recommended for the fabric and soil; sort properly.
 - Use your washer during off-peak hours—usually early morning and late evening. (Ask your power company.)
-

Caring for your washer

- Wipe up detergent, bleach, and other spills with a soft, damp cloth or sponge as they occur.
- Remove hard water deposits using only cleaners labeled as washer safe.
- If the washer interior needs cleaning (for example, after tinting or dyeing), put 1 cup (250 mL) of chlorine bleach and 2 cups (500 mL) of detergent in the washer. Run through a complete cycle using hot water. If staining occurs on following loads, repeat the process.
- Sharp or metal objects can damage your washer. Check pockets for pins, clips, money, bolts, nuts, etc. Do not lay these objects on your washer after emptying pockets.

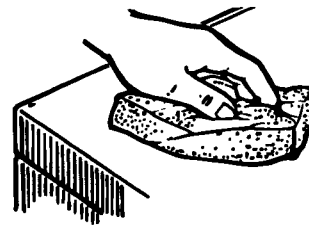

NOTE: Operate your washer only when you are at home.



Care during periods of non-use

Winter storage or moving care

Install and store your washer where it will not freeze. Because some water stays in the washer, freezing can damage it. If your washer is stored or moved during freezing weather, winterize it.

1. Shut off both water faucets. Disconnect and drain water inlet hoses.
2. Put 1 quart (1 L) of R.V.-type antifreeze in the basket.
3. Run washer on a drain and spin setting (see page 9) for about 30 seconds to mix the antifreeze with any water that may be left in the washer.
4. Unplug power supply cord.

To use the washer again:

1. Flush water pipes and hoses.
2. Reconnect water inlet hoses.
3. Turn on both water faucets.
4. Reconnect power supply cord.
5. Run the washer through a complete cycle with 1 cup (250 mL) of detergent to clean out antifreeze.

Non-use/vacation care

1. Unplug power supply cord or turn off electrical power.
2. Turn off water supply leading to your washer. This will help avoid accidental flooding while you are away (for example, due to a water pressure surge).

If You Need Assistance or Service

1. Before calling for assistance ...



Is your water turned on?

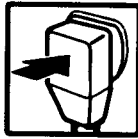

Is the power cord firmly plugged in?



Have you blown a fuse or tripped the circuit breaker?

If you need more help, check the chart below.

PROBLEM	CHECK THE FOLLOWING
Washer will not fill	<p>Is the power cord firmly plugged into a live circuit with proper voltage?</p> <p>Has a household fuse blown or circuit breaker tripped? Has a time-delay fuse been used?</p> <p>Are both hot and cold water faucets open?</p> <p>Are the water supply hoses kinked?</p> <p>Is the Cycle Control Knob set and pulled out?</p>
Washer does not spin	<p>Is the lid closed?</p> <p>Is the power cord firmly plugged into a live circuit with proper voltage?</p> <p>Has a household fuse blown or circuit breaker tripped? Has a time-delay fuse been used?</p>
Washer stops during a cycle	<p>Washer pauses briefly at different times in each cycle. These pauses are normal.</p> <p>Is the power cord firmly plugged into a live circuit with proper voltage?</p> <p>Has a household fuse blown or circuit breaker tripped? Has a time-delay fuse been used?</p>
Washer fills and drains without running	<p>Is the Cycle Control Knob pointing to a cycle setting?</p>
Washer drains during wash and rinse cycles	<p>Adjust the drain hose so that it is higher than the water level in the washer.</p>



If You Need Assistance or Service

2. If you need assistance* ...

- Call KitchenAid Consumer Assistance Center:

1-800-422-1230

One of our trained consultants can instruct you in how to obtain satisfactory operation from your appliance or, if service is necessary, recommend a qualified service company in your area.

- If you prefer, write to:
Consumer Assistance Center
KitchenAid
2000 M-63
Benton Harbor, MI 49022

3. If you need service* ...

- Call your dealer or the repair service he recommends.
- All service should be handled locally by the dealer from whom you purchased the unit or an authorized KitchenAid servicer.
- If you are unable to obtain the name of a local authorized KitchenAid servicer, call our Consumer Assistance Center telephone number (see Step 2).

4. If you are not satisfied with the action taken:

- Contact the Major Appliance Consumer Action Panel (MACAP). MACAP is a group of independent consumer experts that voices consumer views at the highest levels of the major appliance industry.
- Contact MACAP only when the dealer, authorized servicer and KitchenAid have failed to resolve your problem.
Major Appliance Consumer Action Panel
20 North Wacker Drive
Chicago, IL 60606
- MACAP will in turn inform us of your action.

*When asking for help or service:

Please provide a detailed description of the problem, your appliance's complete model and serial numbers, and the purchase date. (See page 2.) This information will help us respond properly to your request.

Don't forget, KitchenAid offers a full line of quality home appliances.

Built-in Refrigerators	Trash Compactors	Ranges & Cooktops
Freestanding Refrigerators	Hot Water Dispensers	Microwave Ovens
50-Pound Ice Makers	Food Waste Disposers	Washers & Dryers
Dishwashers	Built-in Ovens	Mixers & Blenders

For more information on these appliances, or the one you have purchased, call our toll-free Consumer Assistance Center telephone number, **1-800-422-1230**.

KitchenAid® Washer Warranty

LENGTH OF WARRANTY:	KITCHENAID WILL PAY FOR:	KITCHENAID WILL NOT PAY FOR:
ONE YEAR FULL WARRANTY FROM DATE OF PURCHASE.	Replacement parts and repair labor costs to correct defects in materials or workmanship. Service must be provided by an authorized KitchenAid servicing outlet.	A. Service calls to: <ol style="list-style-type: none"> 1. Correct the installation of the washer. 2. Instruct you how to use the washer. 3. Replace house fuses or correct house wiring. 4. Correct house plumbing. B. Repairs when washer is used in other than normal home use. C. Damage resulting from accident, alteration, misuse, abuse, improper installation or installation not in accordance with local electrical or plumbing codes. D. Any labor costs during the limited warranties. E. Replacement parts or repair labor costs for units operated outside the United States. F. Pickup and delivery. This product is designed to be repaired in the home. G. Repairs to parts or systems caused by unauthorized modifications made to the appliance.
SECOND YEAR LIMITED WARRANTY FROM DATE OF PURCHASE.	Replacement parts to correct defects in materials or workmanship.	
SECOND THROUGH FIFTH YEAR LIMITED WARRANTY FROM DATE OF PURCHASE.	Replacement parts for the cabinet assembly should it rust through due to defects in materials or workmanship. For all models with two or three speed motors (includes all models except the KAWL410B and the KAWE470B) replacement parts for the motor to correct defects in materials or workmanship. For solid state touch control models, replacement parts for the solid state controls if defective in materials or workmanship.	
SECOND THROUGH TENTH YEAR LIMITED WARRANTY FROM DATE OF PURCHASE.	Replacement parts for any part of the gearcase assembly to correct defects in materials or workmanship. Replacement parts for the washer outer tub should it fail to contain water due to defects in materials or workmanship.	

KITCHENAID DOES NOT ASSUME ANY RESPONSIBILITY FOR INCIDENTAL OR CONSEQUENTIAL DAMAGES. Some states do not allow the exclusion or limitation of incidental or consequential damages, so this exclusion or limitation may not apply to you.

This warranty gives you specific legal rights and you may also have other rights which vary from state to state.

If you need service, first see the "Assistance or Service" section of this book. After checking "Assistance or Service," additional help can be found by calling our Consumer Assistance Center, **1-800-422-1230**, from anywhere in the U.S.A.

KitchenAid
Benton Harbor, MI, U.S.A. 49022



Printed on recycled paper—
10% post consumer waste
50% recovered materials

Part No. 3362079

© 1994 KitchenAid

® Registered Trademark/TM Trademark of KitchenAid.

Printed in U.S.A.