

This Owner's Manual is provided and hosted by [Appliance Factory Parts](#).

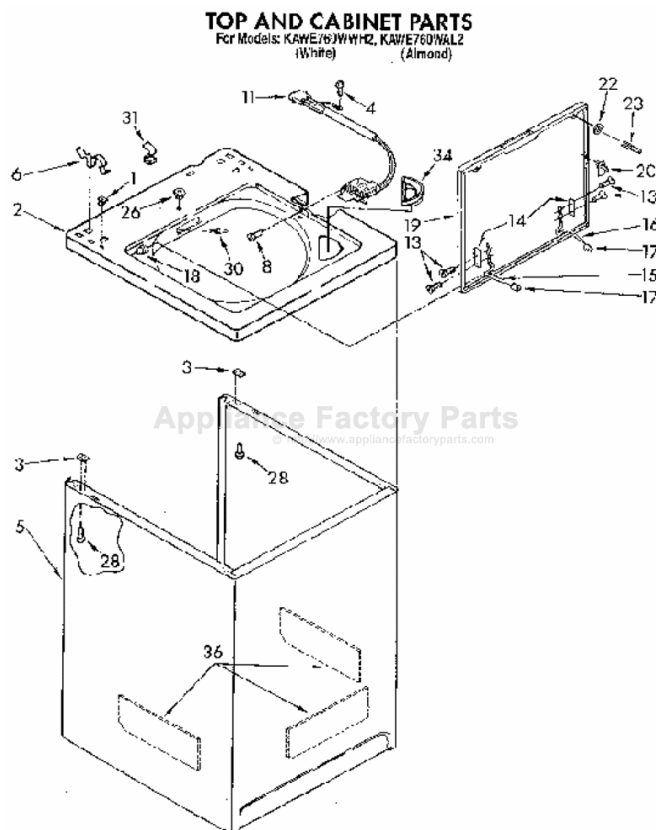

# KITCHENAID KAWE760WAL2 Owner's Manual

[Shop genuine replacement parts for KITCHENAID  
KAWE760WAL2](#)



[Find Your KITCHENAID Washer Parts - Select From 132 Models](#)

----- Manual continues below -----

# **KitchenAid™**

*Extra Capacity Clothes Washer*

**Model KAWE760W**

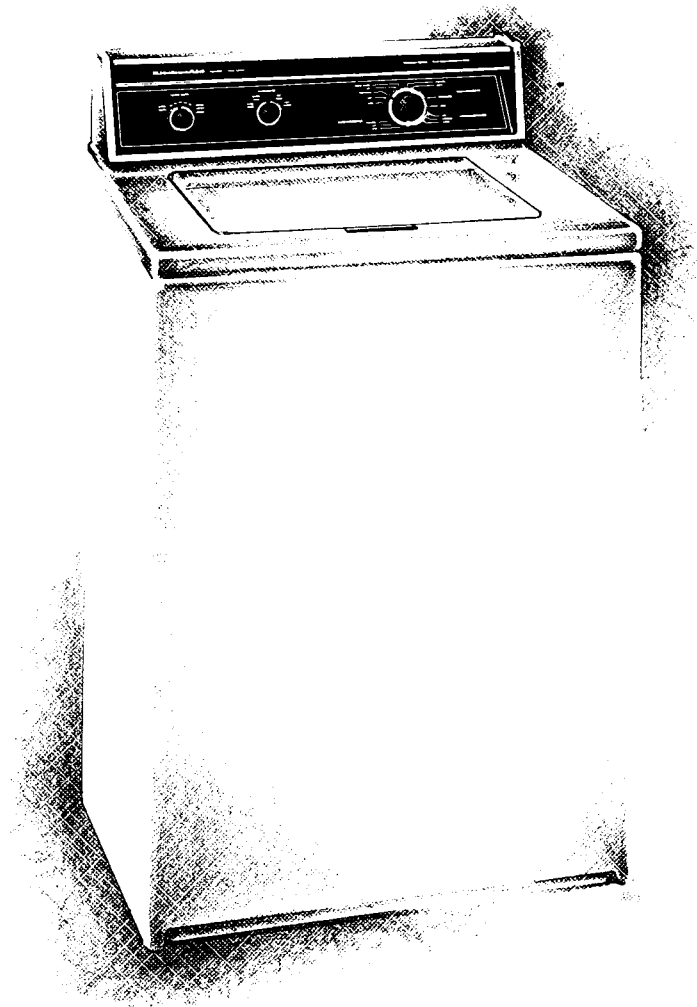

**USE and CARE GUIDE**

# Table of Contents

Important Safety Instructions .....	3
You Are Responsible For .....	4
Ownership Registration .....	4
Clothes Washer Features .....	5
Operating the Clothes Washer .....	6
Water Hardness .....	6
Water Temperature .....	7
Energy Saving Tips .....	8
Load Preparation .....	8
Sorting .....	9
Loading .....	9
Add Soap or Detergent .....	9
Tips on Detergent Use .....	10
Add Sorted Wash Load .....	10
Loading Tips .....	10
Load Sizes and Water Levels .....	11
Loading Suggestions .....	11
Make Selections .....	12
Select a Water Level .....	12
Select Water Temperatures .....	12
Select a Wash Cycle .....	12
Self-Clean Lint Filter .....	12
Pre-Wash Cycle .....	13
Extra Wash Cycle .....	13
Regular/Heavy Cycle .....	14
Permanent Press Cycle .....	14
Knits/Delicates Cycle .....	15
Use of Clothes Washer Dispensers .....	16
Liquid Bleach Dispenser .....	16
Fabric Softener Dispenser .....	16
Caring for the Clothes Washer .....	17
Common Washing Problems and Causes .....	18-19
Laundry Aids .....	19-21
Stain Removal Tips .....	22-24
Caring for Special Items .....	25-28
For Service or Assistance .....	29
KitchenAid Washer Warranty .....	BACK COVER

©1990 KitchenAid

# Important Safety Instructions

## **⚠ WARNING**

To reduce the risk of fire, electric shock, or injury to persons when using the washer, follow basic precautions, including the following:

1. Read all instructions before using the washer.
2. Your washer should be installed in an area protected from weather.
3. Your washer should be connected to a properly grounded 3-prong outlet and the correct electrical supply. See the Installation Instructions for complete information.
4. Never wash articles in the washer that have been spotted, cleaned, washed or soaked in gasoline, wax, paint, or other flammable fluids. The fumes can create a fire hazard or explosion. Never add these materials to your washer, and never use them near your washer. Always hand launder and air dry fabrics treated with flammable fluids.
5. Never allow children to play on or in the washer. Close supervision is necessary when this or any appliance is used near children.
6. Before your washer is removed from service or discarded, always remove the lid to prevent accidental entrapment.
7. Do not tamper with controls.
8. Do not reach into the washer if the agitator is moving or the basket is spinning. If the lid is opened while the basket is spinning, the basket will automatically stop in a few seconds.
9. If the hot water system has not been used for a period of 2 weeks or more, hydrogen gas may build up in water heater and hot water pipes. Hydrogen gas is explosive. If the hot water system has not been used for such a time period, turn on all hot water faucets and let the water flow from each for several minutes before using the washing machine. This will allow gases to escape. Do not smoke or use an open flame during this procedure.
10. Do not install or perform any servicing unless you are qualified. Improper installation, repair, or servicing can result in personal injury or fire hazard.

**SAVE THESE INSTRUCTIONS**

# You Are Responsible For

## **YOU ARE RESPONSIBLE FOR MAKING SURE THAT YOUR WASHER:**

- Is installed by a qualified installer.
- Is properly maintained.
- Is properly installed and leveled on a floor that can support the weight.\*
- Is located in an area where the temperature will not fall below freezing.
- Is properly connected to the right water supply and drain.\*
- Is used only for its intended function.
- Is not run where there may be explosive fumes.
- Is not used by children or anyone unable to operate it properly.

ALWAYS unplug the power supply cord or turn off electrical power before attempting to service the washer.

DO NOT machine wash glass fiber materials. Small particles can stick to fabrics washed in subsequent loads and cause skin irritation.

ALWAYS read and follow instructions on packages of detergent and laundry aids—especially warnings and precautions.

\*See the Installation Instructions for complete information.

## Ownership Registration

Please fill out and mail your Ownership Registration Card packed with the product. The card will enable us to contact you in the unlikely event of a product safety notification and assist us in complying with the provisions of the Consumer Product Safety Act. Return of the card is not necessary to validate your warranty.

You must provide proof of purchase or installation date for in-warranty service.

For your own records, write down the following information in the space provided below. If your washer ever requires service, the service technician may need this information.

**Model Number\*** \_\_\_\_\_

**Serial Number\*** \_\_\_\_\_

**Date Purchased** \_\_\_\_\_

**Date Installed** \_\_\_\_\_

**Dealer's Name** \_\_\_\_\_

**Address** \_\_\_\_\_

**Phone** \_\_\_\_\_

\*Model and serial numbers are located on a plate underneath the lid, near the hinge.

# Clothes Washer Features

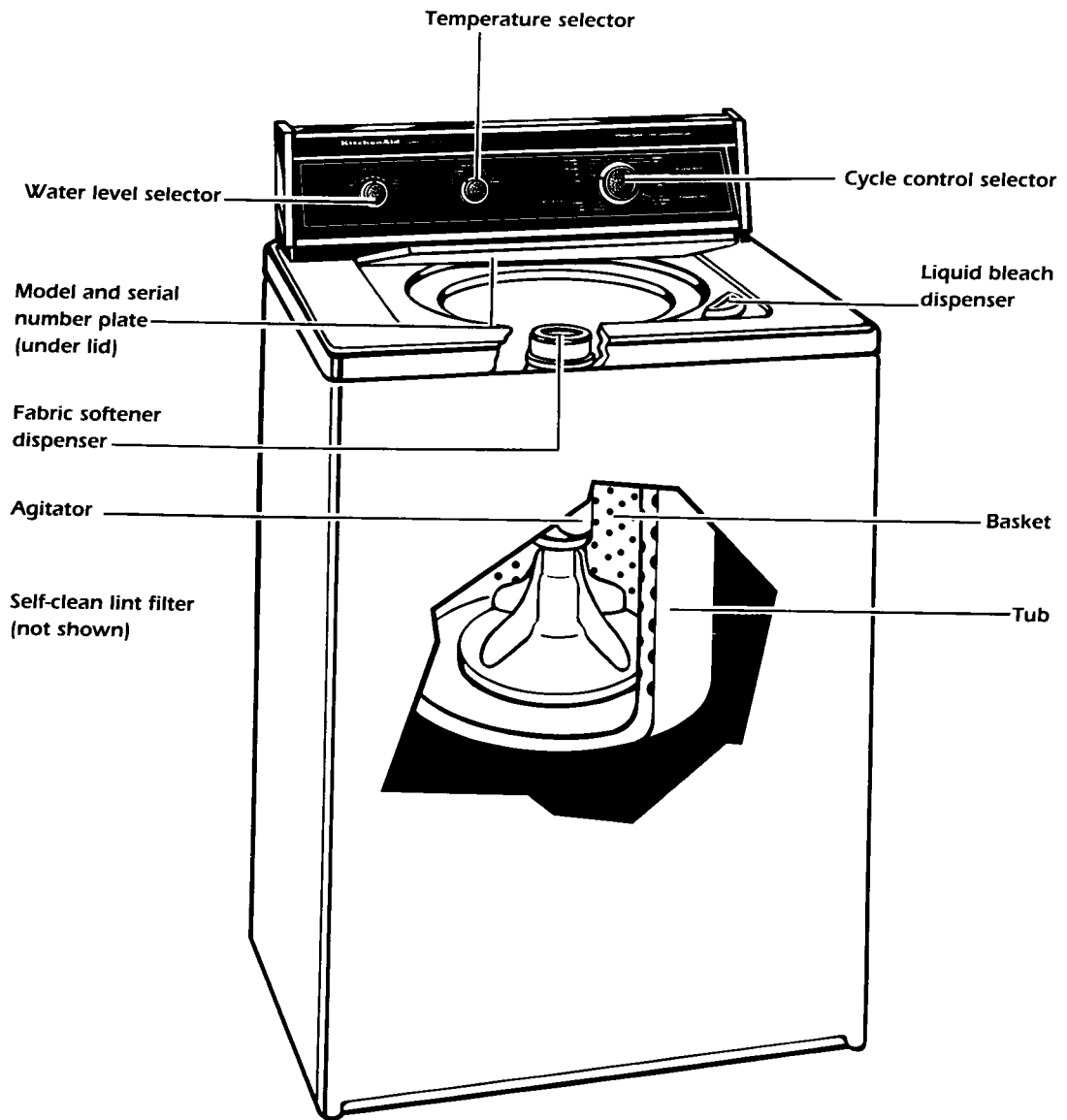

# Operating the Clothes Washer

**Step 1** Add measured detergent. See page 10 for information on detergent use.

**Step 2** Add sorted load. See page 9 for sorting information.

**Step 3** Make selections:

a) Select a water level.

b) Select water temperatures.

c) Select a wash cycle.

See pages 12-15 for a description of selection options.

**Step 4** Close washer lid. The washer will not spin if the lid is left open.

**Step 5** Start the washer. See page 12 for instructions on Cycle Control Selector use.

## Water Hardness

Many complaints of poor washing results can be traced to wash water temperature and hardness.

### Water Hardness

Water with a high mineral content is called hard water. Water deposits and stains in the wash tub are examples of problems caused by hard water.

#### To check water hardness:

- City water—ask the water company. They can tell you the mineral content in grains per gallon or parts per million.
- Well water—check with your Cooperative Extension Service Office.

#### If your water is hard:

- Consider installing a water softener.
- Consider installing an iron filter if the iron content is high.
- Use more detergent. (See table on page 9 for recommended amounts.)
- Do not use soap; use detergent.
- Soften wash and rinse water with a packaged non-precipitating water conditioner.

#### SOFT WATER:

0 to 4 grains per gallon, or 0 to 68 parts per million

#### MEDIUM HARD WATER:

5 to 8 grains per gallon, or 85 to 136 parts per million

#### HARD WATER:

9 to 12 grains per gallon, or 153 to 205 parts per million

#### VERY HARD WATER:

More than 12 grains per gallon, or more than 205 parts per million

# Water Temperature

Water Temperature Guide

Wash Water Temperature	Used For	Comments
<b>HOT</b> 130°F (54°C) or above	<ul style="list-style-type: none"> <li>• White and colorfast cottons.</li> <li>• Heavy soils.</li> <li>• Diapers.</li> </ul>	<ul style="list-style-type: none"> <li>• Gives best cleaning for heavy, oily soils.</li> <li>• Helps prevent greying and yellowing.</li> </ul>
<b>WARM</b> 100°F (38°C)	<ul style="list-style-type: none"> <li>• Normal soiled permanent press and synthetic items.</li> <li>• Dark or non-colorfast colors.</li> <li>• Washable woolens.</li> <li>• Moderate soils.</li> <li>• Knits.</li> </ul>	<ul style="list-style-type: none"> <li>• Less fading and bleeding of dye.</li> <li>• Safe for fabric finishes.</li> </ul>
<b>COLD*</b> 70°-100°F (21.1°-37.8°C)*	<ul style="list-style-type: none"> <li>• Lightly soiled fabrics.</li> <li>• Some non-colorfast colors.</li> <li>• Some normally soiled items with extra detergent.</li> </ul>	<ul style="list-style-type: none"> <li>• Less effective cleaning than hot or warm water.</li> <li>• Dissolve powdered detergent in warm water before adding to washer or use a liquid detergent.</li> <li>• Pretreat spots, stains and heavy, oily soils.</li> <li>• Use longest wash time in cycle selected.</li> </ul>

\*Water can be too cold for effective washing. During cold weather, water may be too cold to dissolve detergent properly. If your tap water is less than 70°F (21.1°C), use a warm wash setting and follow instructions for a cold wash.

**IMPORTANT:** Cold rinses can be used for all loads, as they save energy and help keep wrinkles from setting into fabrics. Use warm wash water and cold rinse water for PERMANENT PRESS and KNITS/DELICATES Cycles to minimize wrinkling.

# Energy Saving Tips

1. Use hot water only when necessary (heavy or greasy soils, whites, etc.). Use cold water for light soils.
2. Use cold rinses.

Although a warm water rinse is available, cold rinses are recommended for all loads, as they save energy and help keep wrinkles from setting into fabrics.

A load rinsed in cold water may take longer to dry than one rinsed in warm water; however, more energy is used to heat the water for a warm rinse than is used during the longer drying time.
3. Full loads make the best use of water-heating energy. If proper sorting results in less than full loads, adjust the water level to the size of the load.
4. Avoid rewashing.
  - Use recommended amount of detergent based on soil level, load size and water hardness. See loading information on page 9.
  - Do not overload the washer. See page 11 for loading suggestions.
  - Use the cycles and wash times recommended for the wash load, fabric type and soil level.
  - Sort the wash load correctly. See Sorting, page 9.

## Load Preparation

For best results, the following steps should be taken to prepare your clothes for washing:

- Make sure all pockets are empty. Tissues and other paper left in pockets can leave lint throughout the wash load. Turn pockets inside out.
- Turn cuffs down and brush away lint and dirt.
- Remove pins, buckles and other sharp objects and close zippers, snaps and hooks. This will help avoid scratching the basket, damaging the agitator and snagging other load items.
- Remove unwashable trim and ornaments.
- Tie strings and sashes so they won't tangle.
- Mend tears, loose hems and seams.
- Treat spots and stains. See the Stain Removal Tips section on pages 22-24.
- Turn synthetic knits inside out. This will help avoid pilling. Some knits are stretched during manufacturing, and may shrink slightly during laundering.

# Sorting

Always sort carefully for best washing results.

## Sort by fabric and construction

- Sturdy cottons such as jeans, towels, work clothes.
- Knits such as sweaters and double knit clothing.
- Delicate items such as lingerie and fine washables.

## Sort by color

Always wash synthetics and light-colored permanent press as a separate load, as they will easily pick up color from non-colorfast garments.

## Separate heavily soiled items

Even if a garment would normally be washed with lightly soiled items, if it is heavily soiled, it should be washed separately. This will help other lightly soiled load items to become more thoroughly cleaned.

## Separate lint givers from lint takers

Lint givers are laundry items that have a high cotton content (chenille, bath towels, sweatshirts), and lint takers are high in synthetic content (permanent press, knit sweaters) or tend to collect lint (corduroy). When possible, turn lint givers inside out.

# Loading

When loading your washer, be sure to follow the proper sequence:

- add soap or detergent,
- add sorted wash load,
- make selections/start washing.

## Add Soap or Detergent

If soap or detergent is added directly on top of clothing, stains may result (especially with liquid detergents).

The following chart shows the correct amount of soap or detergent to use, based on the type of detergent and the level of water hardness in your wash water.

**IMPORTANT:** In areas where phosphate detergents are not allowed:

- Use increased amounts of liquid detergent, based on the level of water hardness and amount of soil in the wash load.
- Use a non-precipitating water conditioner in the wash and deep rinse.
- Install a mechanical water softener if water is very hard and soap (not a synthetic detergent) is used.

### Extra Capacity Washer (highest water level only)

	WATER HARDNESS IN GRAINS			
	0-4 gr.	4-10 gr.	10-20 gr.	20+ gr.
Powdered Detergents				
concentrated low suds/phosphate	1/2 c.	3/4-1 c.	1 1/4c.	1 1/2 c.
normal suds/phosphate	1 c.	1 1/4 c.	1 1/2-1 3/4 c.	2 c.
concentrated low suds/ non-phosphate	1/2-3/4 c.	1 c.	1 1/4-1 1/2 c.	1 3/4-2 c.
normal suds/non-phosphate	1 c.	1 1/3 c.	1 3/4 c.	2 c.
Liquid Detergents	1/4-1/2 c.	1/2-3/4 c.	1 c.	1 1/4 c.

## Tips on Detergent Use

- Measure your detergent carefully. Use the correct amount based on level of water hardness and the amount of wash load soil.
- Using too little detergent is a common cause of laundry problems. You need enough detergent to hold the soil as it drains away with the wash water.
- Detergent package directions are usually based on:
  - moderate water hardness (4 to 6 grains)
  - lightly soiled items
  - normal mixed loads
- Follow package directions carefully, but use more detergent for:
  - hard water
  - cooler wash water
  - full loads
  - heavily soiled items
- Do not judge the amount of detergent to use by the amount of suds in the wash basket. Some detergents will generate less suds than others.
- If too many suds are generated by the recommended amount of your detergent, try a low suds detergent. Do not reduce the amount of your current detergent to less than the recommended amount, as clothes may not become clean.

## Add Sorted Wash Load

Add the wash load before starting the wash cycle. When clothes are added to the washer after the tub is full of water the washer may tend to become overloaded.

**IMPORTANT:** Do not overload. Overloading or packing can:

- cause poor cleaning
  - increase wrinkling
  - cause excessive lint
  - wear out items faster (example: pilling)
  - tear clothing
- Refer to page 11 for loading suggestions.

## Loading Tips

- Load by the amount of space items take up.
- Drop items in loosely, filling to the top of the basket. Do not wrap around agitator because damage to clothing may result.
- Load evenly to maintain washer basket balance during washing and spinning. An off-balance load can cause the washer to vibrate during a spin cycle.
- Mix large and small items in each load for ease of load movement through the wash water. This will help give the best cleaning with wrinkle-free results. If the washer is loaded correctly, items will go below the water surface and reappear later.
- To reduce wrinkling, permanent press and synthetic knits should have more room to move in the water than items such as towels and jeans.
- When washing very large items, such as king or queen-size sheets, do not load the washer as full as with other loads. Large sheets require more space in the wash basket for movement and proper cleaning.

## Load Sizes and Water Levels

Do not overload the washer.

For best cleaning results, the load must be able to move freely in the washer. Too big a load or too little water can cause wear or tearing of load items.

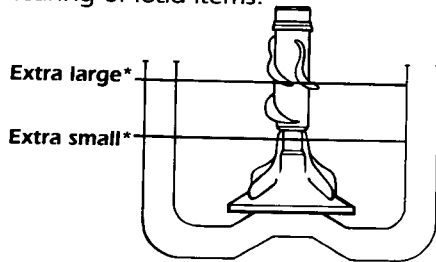

\*Approximate fill with load.

## Loading Suggestions

### (Extra Large Water Level)

Smaller load sizes should be washed in lower water levels.

### Mixed Load

- 3 double sheets
- 4 pillowcases
- 8 T-shirts
- 6 pair shorts
- 2 shirts
- 2 blouses
- 8 handkerchiefs

### Permanent Press

- 2 double or 1 king-size sheet
- 1 tablecloth
- 1 dress
- 1 blouse
- 2 slacks
- 2 pillowcases

### Heavy Work Clothes

- 3 pair pants
- 3 shirts
- 4 pair jeans
- 1 coverall
- 1 overall

### Knits

- 3 slacks
- 3 blouses
- 6 shirts
- 4 tops
- 4 dresses

### Towels

- 10 bath towels
- 10 hand towels
- 14 wash cloths
- 1 bathmat

### Delicates

- 3 camisoles
- 1 quilted robe
- 4 slips
- 4 panties
- 2 bras
- 2 nighties
- 1 baby's dress

# Make Selections

## **⚠ WARNING**

To reduce the risk of fire, electric shock or injury to persons, read the Important Safety Instructions on page 3 before operating your washer.

### Select a Water Level

To set the correct water level, turn the Water Level Selector anywhere on or between EXTRA SMALL and EXTRA LARGE to the level that describes the size of your wash load.

- EXTRA SMALL, for a few small items.
- EXTRA LARGE, for a full load.

To change the water level after the washer has started to fill, turn the selector to RESET, then to the desired water level.

### Select Water Temperatures

Choose a wash temperature (top) and a rinse temperature (bottom) by turning the Temperature Selector to the desired temperature combination. Refer to the Water Temperature Guide, page 7, for recommended water temperatures.

### Select a Wash Cycle

To select a wash cycle, push the Cycle Control Selector in and turn to the right. Stop at the NORMAL setting in the wash cycle of your choice.

For garments with lower soil levels that may require less washing time, the REGULAR/ HEAVY and PERMANENT PRESS Cycles also offer a LIGHT setting.

Start the washer by pulling the Cycle Control Selector out.

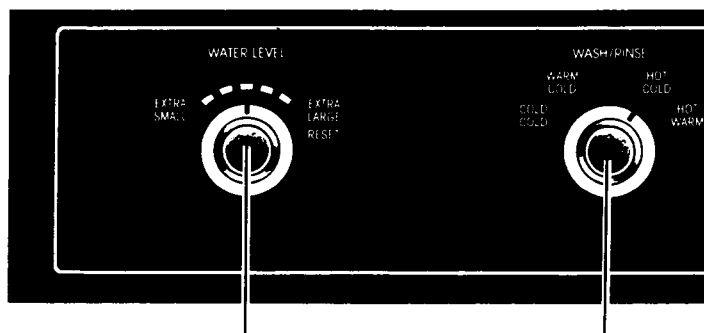

Water level selector

Temperature selector

Each cycle has been designed for different kinds of fabrics. When a cycle has been chosen and the knob is pulled out, the washer fills before the agitation and timing starts. After agitation begins, the washer automatically times each part of the selected cycle until it ends and the washer shuts off.

You may hear the sound of water spraying during the spin of some cycles as cold water is sprayed on the spinning load to help with rinsing.

To stop the washer at any time, push the Cycle Control Selector in. To restart the washer, pull the Cycle Control Selector out.

**IMPORTANT:** If you are using a fabric softener, do not stop the washer before the final rinse. Staining can occur.

### Self-Clean Lint Filter

As load items are being washed, lint particles from the wash water automatically collect on the SELF-CLEAN LINT FILTER located between the basket and tub. As the washer drains, collected lint is carried away with the wash and rinse water. If the washer drains into a tub, remove any lint collected in the drain or strainer.

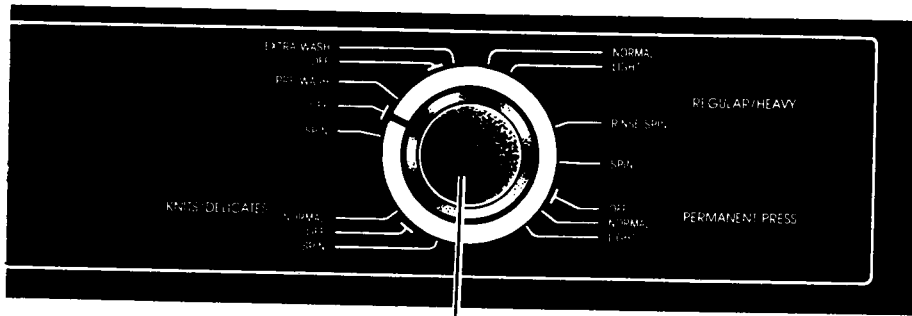

Cycle control selector

### *Pre-Wash Cycle*

Heavily soiled items that require maximum soil removal or stained items that need extra care may need to be pre-washed for best cleaning.

A brief period of pre-washing helps loosen soils and remove stains.

When using the PRE-WASH Cycle, use enough detergent for one wash. Add detergent again when setting the washer for one of the other wash cycles.

**Cycle Sequence is as follows:**

**FILL** to Selected Level

▼  
**PRE-WASH** 4 Minutes, High Speed

▼  
**DRAIN** No Agitation

▼  
**SPIN** Medium Speed

▼  
**WASHER STOPS** Select Wash Cycle

Special stains may need special treatment. See Stain Removal Tips, pages 22-24.

### *Extra Wash Cycle*

Heavily soiled items that require maximum soil removal may be run through the EXTRA WASH Cycle.

Double the recommended amount of detergent when using this cycle.

**Cycle Sequence is as follows:**

**FILL** To Selected Level

▼  
**WASH** 4 Minutes, High Speed

▼  
**PARTIAL DRAIN** (Pause)

▼  
Washer Automatically Advances to the **REGULAR/HEAVY CYCLE**

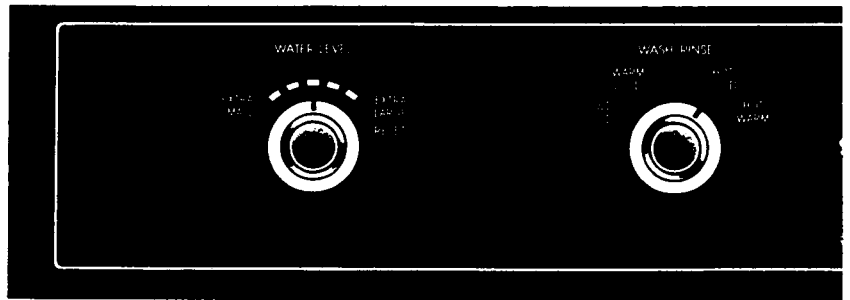

## Regular/Heavy Cycle

This cycle is used for heavily soiled items and fabrics of sturdy construction, such as work clothes, denim jeans and coveralls.

### Cycle Sequence is as follows:

**FILL** to Selected Level

▼  
**WASH** 10 Minutes, High Speed

▼  
**DRAIN** No Agitation

▼  
**SPIN** Medium to High Speed

▼  
**FILL** for Deep Rinse

▼  
**RINSE** High Speed

▼  
**DRAIN** No Agitation

▼  
**SPIN** Medium to High Speed,  
2 Spray Rinses

\* **NORMAL** setting features both High and Low Speed washes.

\*\* **LIGHT** setting features Low Speed wash only.

## Permanent Press Cycle

This cycle features a **COOL DOWN** rinse that occurs before the total wash time has elapsed. The cool down rinse helps to keep wrinkles from setting into synthetic fabrics and clothes with a permanent press finish.

**IMPORTANT:** For best results with this cycle, always select a wash water temperature that is combined with a cold water rinse. Using cold rinse water saves energy and helps minimize wrinkling.

### Cycle Sequence is as follows:

**FILL** to Selected Level

▼  
**WASH** 4 Minutes, High Speed\*

▼  
**WASH** 4 Minutes, Low Speed\*\*

▼  
**PARTIAL DRAIN** (Pause)

▼  
**REFILL COOL DOWN**

▼  
**WASH** 2 Minutes, High Speed

▼  
**DRAIN** No Agitation

▼  
**SPIN** Medium Speed

▼  
**FILL** for Deep Rinse

▼  
**RINSE** High Speed

▼  
**DRAIN** No Agitation

▼  
**SPIN** Low Speed to Medium to High Speed, 2 Spray Rinses

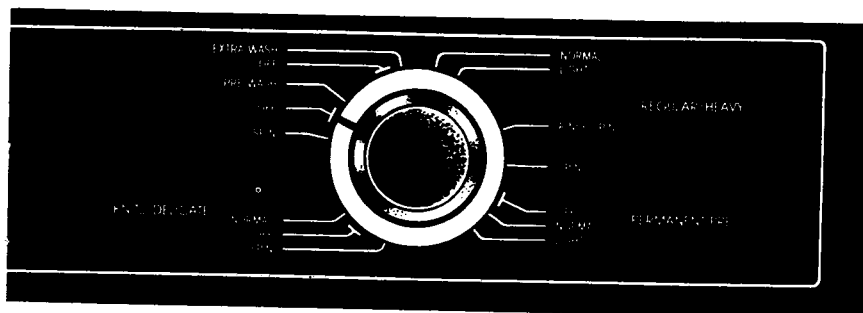

## *Knits/Delicates Cycle*

Delicate items and washable knits are washed and spun gently on this cycle. Nylon hosiery should be washed in a net laundry bag to avoid tangling.

### **Cycle Sequence is as follows:**

**FILL** to Selected Level

---

▼  
**WASH** 6 Minutes, Low Speed

---

▼  
**DRAIN** No Agitation

---

▼  
**SPIN** Medium Speed

---

▼  
**FILL** for Deep Rinse

---

▼  
**RINSE** Low Speed

---

▼  
**DRAIN** No Agitation

---

▼  
**SPIN** Medium Speed, 2 Spray Rinses

---

# Use of Clothes Washer Dispensers

## Liquid Bleach Dispenser

The bleach dispenser is located near the lower right edge of the washer tub opening.

**Always measure bleach—never use more than 1 cup for a full load.** Use less bleach with lower water level settings.

- Follow directions on bottle for safe use.
- Use a cup with a pouring spout to avoid spilling.

### TO USE:

1. Add detergent and load to basket.
2. Pour measured bleach carefully into dispenser. **DO NOT** let bleach splash, drip or run down into the washer basket.

**Undiluted bleach will damage any fabric it touches.**

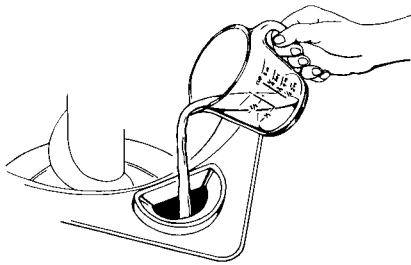

3. Start the washer. Bleach will be diluted automatically during the wash part of the cycle.

For more information on the use of chlorine bleach, see page 19.

## Fabric Softener Dispenser

### TO USE:

1. Add detergent and load to basket.
2. Add liquid fabric softener to the dispenser following the instructions recommended on the bottle. Avoid dripping or spilling any fabric softener on the load because fabrics can stain.

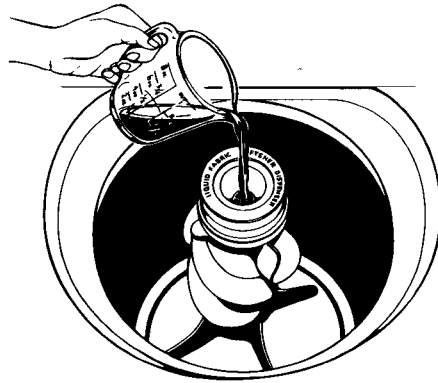

3. Add warm water to fill dispenser until liquid reaches the opening.
4. Diluted fabric softener will be added to the load when the washer fills for the rinse part of the cycle.

**IMPORTANT:** Do not stop the washer before the final rinse. Staining can occur.

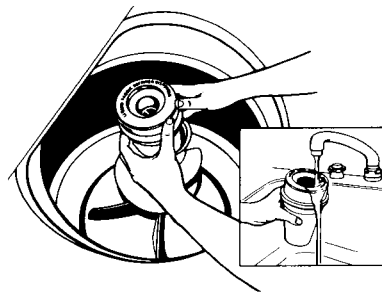

5. Clean dispenser after each use with warm water. To remove the dispenser, grasp the top of the dispenser with both hands. Squeeze and push upward with thumbs to remove. Clean by holding under water faucet. Replace after cleaning.

**IMPORTANT:** Do not add detergent to dispensers. The dispensers can clog.

For more information on the use of fabric softeners, see page 20.

# Caring for the Clothes Washer

When not washing, keep both water faucets off. This takes the pressure off the water inlet valve and hoses.

For maximum use satisfaction and longer washer life, follow these guidelines:

- Wet or damp laundry should not be stored in your washer for an extended period of time.
- Do not use vinegar or other acids in your washer.
- Do not place urine-soaked clothing in the washer without appropriate amounts of water and detergent.
- Clothing may be soaked in your washer as long as sufficient amounts of detergent have been added to the water. If chlorine bleach is needed for soaking, it may be used as long as detergent is present in the water.
- Sharp or heavy objects should never be placed in the washer.

Failure to follow these guidelines may result in damage to the washer basket finish.

To clean washer exterior, wipe with a soft damp cloth. To clean washer interior, put chlorine bleach and detergent in the washer. Run through a complete cycle, using hot water.

---

Service or performance problems caused by the use of any product not manufactured by KitchenAid are the responsibility of the manufacturer of that product.

---

## Winterizing

Because a small amount of water stays in the washer pump after draining, freezing can cause a lot of damage. If your washer is stored or moved during the cold weather, follow this procedure:

1. Shut off both water faucets.  
Disconnect and drain water inlet hoses.
2. Pour 1 quart of R.V.-type antifreeze in the basket.
3. Set the washer to the spin portion of the REGULAR/HEAVY Cycle, and turn the washer on. Allow the washer to run about 30 seconds to mix the antifreeze and water, then push the Cycle Control Selector in, stopping the washer.

## To Use the Washer Again

The winterizing procedure mixes antifreeze into the water pump to protect against freezing and damage. Before the washer is used again, the antifreeze must be removed from the pump by following these steps:

1. Flush the water pipes and hoses.
2. Connect hoses to the washer.
3. Turn on the water faucets.
4. Run the washer through a complete REGULAR/HEAVY Cycle, without clothing, using one cup of detergent.

# Common Washing Problems and Causes

Problem	Cause
<b>Brown or Yellow Stains</b>	<ul style="list-style-type: none"> <li>• chlorine staining</li> <li>• iron in water heater or pipes</li> <li>• iron and manganese in water</li> <li>• rust spots in washer basket (see page 17 for tips on washer care)</li> </ul>
<b>Dye Transfer</b>	<ul style="list-style-type: none"> <li>• improper sorting</li> <li>• load left in washer</li> </ul>
<b>Gray Whites or Dingy Colors</b>	<ul style="list-style-type: none"> <li>• improper sorting</li> <li>• water temperature too low</li> <li>• not enough detergent</li> <li>• using soap in water that is too hard</li> </ul>
<b>Greasy Looking Spots</b>	<ul style="list-style-type: none"> <li>• undiluted fabric softener</li> <li>• fabric softener in wash water</li> <li>• not enough detergent</li> </ul>
<b>Lint</b>	<ul style="list-style-type: none"> <li>• improper sorting</li> <li>• paper or tissue in pockets</li> <li>• pilling being mistaken for lint</li> <li>• overloading</li> <li>• not enough detergent</li> <li>• clogged lint filter</li> </ul>
<b>Load Too Wet After Spin</b>	<ul style="list-style-type: none"> <li>• cold rinses</li> <li>• lid is opened before spinning is completed</li> </ul>
<b>Shrinking</b>	<ul style="list-style-type: none"> <li>• fabric type (some knits stretch during manufacturing, and laundering returns fabric to original size)</li> <li>• care label directions not followed</li> </ul>
<b>Snags, Rips, Holes</b>	<ul style="list-style-type: none"> <li>• misuse of chlorine bleach</li> <li>• sharp articles not removed from pockets, etc.</li> <li>• overloading</li> <li>• items damaged before washing</li> <li>• fasteners not fastened</li> </ul>
<b>Stiff, Rough Fabrics (usually Cottons)</b>	<ul style="list-style-type: none"> <li>• using soap in water that is too hard (use detergent if you live in a hard water area)</li> <li>• not enough detergent</li> <li>• line drying</li> </ul>
<b>Twisting/Tangling</b>	<ul style="list-style-type: none"> <li>• overloading</li> <li>• improper loading</li> </ul>

<b>Wrinkling</b>	<ul style="list-style-type: none"> <li>• overloading</li> <li>• load not immediately removed from washer after cycle is completed</li> <li>• improper rinse temperature</li> <li>• poor permanent press finishes</li> <li>• cycle selection is incorrect, based on fabric type</li> </ul>
<b>Yellow Areas–Built-Up Body Oils</b>	<ul style="list-style-type: none"> <li>• water temperature too low</li> <li>• not enough detergent</li> </ul>

## Laundry Aids

**⚠ WARNING**

**Personal Injury and Fire Hazard**

**Keep stain removal products out of the reach of children... preferably in a locked cabinet. To help avoid the danger of a fire or explosion:**

- NEVER store flammable solvents or liquids near your washer.**
- NEVER put dry-cleaning solvents or fluids directly into your washer.**
- NEVER put items treated with solvents in your washer until they have been completely rinsed and air dried.**
- The fumes from these substances can create a fire hazard or explosion.**

Soap or detergent is used to help:

- Loosen and remove soil from items in the load.
- Hold soil and lint in the water so they can be drained away with the water.

If too little soap or detergent is used, soil and lint can settle back on the clothes.

The following pages list some common laundry aid products and techniques for best washing results.

Follow all package directions carefully.

### Chlorine Bleach

- Use bleach only in the wash so that it can be removed in the rinse.
- Follow directions on care labels. Do not use chlorine bleach on wool, silk, spandex, acetates or some flame-retardant fabrics.
- Do not use chlorine bleach in water high in iron. Yellow stains or spotting may result.
- Always measure bleach and follow package directions. Never use more than 1 cup for a full load.
- Undiluted bleach will damage any fabric. The damage appears as rips, holes or tears, and may not show up until several washings later.
- If you do not use your bleach dispenser:
  1. Let the washer fill and begin agitating the load and detergent.
  2. Dilute measured bleach in 1 quart of water.
  3. Pour diluted bleach around agitator, not directly on the load.

### **All-Fabric Bleach**

Powdered or liquid all-fabric bleach may be used on all types of fabrics. Use according to package directions with detergent. Do not use all-fabric bleach in the bleach dispenser because it may clog.

### **Bluing**

Dry bluing (beads or flakes) may be added to the basket before adding soap or detergent. Liquid or tablet bluing should be mixed with 1 quart of warm water and added to the deep rinse. Follow package directions carefully.

### **Ammonia**

Ammonia helps detergent work better by helping to cut grease and heavy soil.

## **⚠ WARNING**

**Personal Injury Hazard**  
**Never use chlorine bleach with ammonia or acids such as vinegar or rust remover. Hazardous fumes can be formed.**

### **Pretreatment Products**

Always follow the manufacturer's instructions with any pretreatment product. Aerosol applications remove oily soils on both cotton and polyester fabrics better than pump or squirt applications.

### **Enzyme Laundry Products**

Some pre-soak products and regular detergents contain enzymes. Enzymes help break down protein-type stains such as blood, baby formula, meat juice and vegetable protein stains such as grass and tomatoes. Dissolve enzyme laundry products in warm water to help prevent spot fading of colored items.

### **Fabric Softeners**

Fabric softeners help make fabrics soft and also help reduce static electricity and fabric wrinkling.

- Follow package directions carefully.
- Always dilute fabric softeners with 1/2 to 1 cup (125 to 250 mL) of warm water. Undiluted fabric softener can stain fabrics.
- Use only in deep rinse. Do not mix with any other laundry products. This includes detergent, packaged water conditioners and bleaches. Mixing may cause greasy stains. Stains from fabric softeners can be removed by wetting the stain and rubbing it with liquid detergent or a bar of soap. Re-wash the stained item.
- Use correct amount. Too much fabric softener can make some items nonabsorbent (like diapers and towels). If this happens, either use less fabric softener or don't use it every time.
- Use the fabric softener dispenser. See page 16 for use information.

### **Packaged Water Conditioners**

If your water is hard, laundry results will be better if you use a non-precipitating water conditioner. Non-precipitating water conditioners soften water by tying up hardness minerals so they will not be deposited on clothes (resulting in yellow or brown stains) and washer parts. Follow package directions for the correct use.

### **Tints and Dyes**

Use tints and dyes in the washer according to instructions on the package. When you are finished with the tinting process, put chlorine bleach and detergent in the washer. Run through a complete cycle using hot water to remove excess dye or tint. If staining occurs on subsequent loads, repeat the above process.

**IMPORTANT:** Washer parts such as the agitator, washer lid, etc. may pick up dye color. Parts may be permanently discolored.

### **Disinfectants**

You may want to use a disinfectant when...

- Someone has an infection or a contagious illness.
- Someone other than your family uses the washer.
- You use cold water for washing.

To disinfect a load...

- Select a disinfectant safe for the fabrics and colors in the load.
- Read and follow the package label carefully.
- Note any cautions.
- Measure disinfectant carefully and according to instructions.
- Do not use any disinfectant other than liquid chlorine bleach in the bleach dispenser.

To disinfect the washer...

- Set the controls for a hot wash with a low water level.
- Pour 1 cup liquid chlorine bleach into the basket.
- Run the washer through a complete cycle.

### **Starch**

Starch adds crispness and body to fabrics. It is available in spray or powder form. Follow the package directions carefully.

# Stain Removal Tips

1. Most stains are easier to remove when they are fresh.
2. Before treating any stain find out...
  - What kind of stain it is.
  - What kind of fabric it is and how colorfast it is (check label).
  - How old the stain is. (Washing and drying can set some stains.)
3. Heat (hot or warm wash, or dryer) can make some stains permanent. Pre-treat such stains or soils before washing.
4. When bleach is recommended, use a bleach that is safe for the fabric. See comments on bleach use, page 19.
5. Test stain remover on an inside seam or hidden corner of the item to see if color is removed.
6. Put the stained area face down on a paper towel or white cloth. Apply the stain remover to the back of the stain. This can force the stain off the fabric instead of through it.
7. A meat tenderizer or enzyme pre-soak will help break down some protein stains so they will be easier to remove.
8. Use dry-cleaning solvents in a well-ventilated room.
9. Stubborn stains may require more than one treatment. Do not machine dry between washings, or stain may become set.

The following items are often used in stain removal and may be kept on hand:

- Ammonia
- Alcohol (denatured or rubbing)
- A bar of soap
- Bleach
- Meat tenderizer
- Non-flammable dry-cleaning solvent
- Pre-wash soil and stain removers (liquid, spray, powder, enzyme pre-soak products)

Pay attention to warnings and cautions on the product labels.

## Alcoholic Beverage

These stains turn brown with age, so **treat immediately**. Sponge or soak fresh stains with cold water. Wash. If stains remain, soak 15 minutes in a solution of lukewarm water, liquid detergent and a few drops of white vinegar. Rinse and re-wash.

## Blood

Rinse immediately or soak in cold water with enzyme pre-soak for 30 minutes or longer. Rinse. Rub detergent into any remaining stains. Rinse. If stains remain, put a few drops of 3% hydrogen peroxide on stain for 3-5 minutes. Rinse thoroughly. Wash.

## Chocolate or Coffee

Sponge immediately with a **non-flammable dry-cleaning solvent** or apply a pre-wash soil and stain remover. Wash. If stain remains, apply a liquid detergent to stain or soak in warm water with an enzyme pre-soak. Re-wash.

## Chewing Gum

Use ice to make gum hard. Scrape off what you can. Sponge with a **non-flammable dry-cleaning solvent**. Let dry. Wash.

## Crayon and Candle Wax

Scrape off excess wax with dull knife. Sponge with a **non-flammable dry-cleaning solvent**. Wash. If stain remains, soak in an enzyme pre-soak or all-fabric bleach. Wash.

### **Cream, Milk or Ice Cream**

Sponge with a **non-flammable dry-cleaning solvent**, or a pre-wash soil and stain remover. Wash. Repeat if necessary. If stains remain, apply a few drops of liquid detergent and a few drops of ammonia. Blot and rinse. If stains remain, soak in an enzyme pre-soak. Wash.

### **Deodorants and Antiperspirants**

**Light stain**—Treat with liquid detergent or your regular laundry detergent. Wash in hottest water safe for fabric.

**Heavy stain**—Place face-down on towel and treat with a paste of ammonia and all-fabric bleach. Let stand for 30 minutes. Wash in hottest water safe for fabric.

### **Fabric Softener**

Wet the stain and rub with liquid detergent or bar of soap. Re-wash the stained item.

### **Fat, Grease or Oil**

Try any of the following treatments:

1. Use pretreatment stain remover. Follow label directions. Wash in hottest water safe for fabric.
2. Use talcum powder to absorb as much grease as possible. Sponge with a **non-flammable dry-cleaning solvent**. Wash.
3. Treat with liquid detergent or rub a detergent paste on the stain. Wash using hottest water safe for fabric.

### **Fruit stains**

Do not use soap on fruit stains. It will set stains.

**Fresh stains:** Soak immediately in cool water. Wash. If stains remain, cover area with a paste made of all-fabric bleach, a few drops of hot water and a few drops of ammonia. Wait 15 to 30 minutes. Wash.

**Old stains:** Sponge with white vinegar. Rinse. Repeat procedure for fresh stains.

### **Grass or Green Vegetables**

Soak in warm or cold water, or sponge with denatured alcohol. Wash in water temperature and bleach safe for the fabric. For colored fabrics, check colorfastness before applying alcohol. On acetate fabrics, sponge with a **non-flammable dry-cleaning solvent**. If stains remain, bleach with 3% hydrogen peroxide. Rinse. Re-wash.

### **Ink or Ballpoint Pen Ink**

Spray stain with an aerosol hair spray, acetone or rubbing alcohol. Sponge stain continuously until all bleeding stops. Let dry. Repeat if necessary. Wash. If stain remains, bleach if safe for fabric. (India and other indelible inks are almost impossible to completely remove.) Avoid use of acetone on acetate, triacetate or modacrylics (for example, stuffed toys and synthetic furs).

### **Iron or Rust**

**For colored or non-colorfast items** apply lemon juice and salt. Place in the sun to dry. Rinse thoroughly. Repeat if necessary.

**For white or colorfast items** a liquid rust remover, available at grocery stores, may be effective. Test first on inside seam or hem.

## **⚠ CAUTION**

**When using rust remover, follow package directions carefully. Some rust removers can harm the washer's top and basket finish.**

**Lipstick**

Apply **non-flammable dry-cleaning solvent** or pre-wash soil and stain remover. Blot with absorbent material. Repeat if necessary. Rinse. If stain still remains, rub with liquid detergent. Wash.

**Meat Juice, Egg**

Scrape off excess egg with dull side of tableknife. Soak in cold or warm water with enzyme pre-soak at least 30 minutes. Treat grease stains with a **non-flammable dry-cleaning solvent**. Wash.

**Mildew**

Wash in hottest water safe for fabric. If stain remains, soak in warm water and an all-fabric bleach for 15 to 30 minutes. Re-wash. (Old mildew stains are almost impossible to remove. Mildew fungus destroys or weakens fabrics.) An alternative to bleach is to treat with salt and lemon juice and dry in direct sunlight. Rinse and re-wash.

**Mustard**

Treat immediately. Scrape off excess mustard. Sponge with a **non-flammable dry-cleaning solvent** or a pre-wash soil and stain remover. Rinse. Work liquid detergent and a few drops of vinegar into stain. Rinse. If stain remains, apply 3% hydrogen peroxide. Rinse and wash.

**Paint**

**Water base**—Treat stains while still wet. These paints cannot be removed after they have dried. Rinse in warm water to flush out paint. Sponge with a **non-flammable dry-cleaning solvent** and then wash.

**Oil base**—Scrape off fresh paint. Sponge with a **non-flammable dry-cleaning solvent** or treat stain with recommended thinner. While stain is wet with solvent, rub liquid detergent into it. Wash with hottest water safe for fabric.

**Perspiration**

**Remove stains before ironing. Perspiration stains may weaken fabric.** Wash or sponge stains thoroughly with detergent and warm water. If perspiration has changed the color of the fabric, use one of the following treatments:

**Fresh stains:** Apply ammonia to stains. Rinse. Launder to remove ammonia odor.

**Old stains:** Apply white vinegar to stains. Rinse. Launder to remove vinegar odor.

**Scorch**

**Severe scorch cannot be removed.** Wet stain with 3% hydrogen peroxide. Cover with a dry cloth and press with an iron as hot as is safe for fabric. Rinse well. Wash, or wet with lemon juice and spread in the sun to dry. Wash.

# Caring for Special Items

Most items have care labels with laundering instructions. Always follow label directions when they are available. General laundering instructions for some special washables are included in this section.

## **Blankets and Woolens**

- Electric Blankets (check manufacturer's recommendations)
- Woolen Blankets
- Washable Woolen Garments
  1. Measure blanket or trace outline of garment before washing.
  2. If binding is extremely soiled, brush with a concentrated solution of soap or detergent.
  3. Add detergent or mild soap and water conditioner to basket. Fill and agitate briefly to dissolve detergent.
  4. Stop washer; unfold blanket. Load in washer evenly around agitator. Soak 10 to 15 minutes.
  5. Start washer. Set control to drain and spin. Spin about 1 minute. (See washer instructions.)
  6. Fill washer for deep rinse. (If you wish to use a fabric softener to increase fluffiness or reduce static electricity, add it during the deep rinse.) Allow the washer to rinse, drain and spin.
  7. Lay item on flat surface and block by gently stretching to original measurement. Woolens tend to shrink more the first time they are washed. This is normal.

For best results, follow the care label drying instructions.

To dry on line, choose a breezy day and hang blanket in shade over two lines. Pin binding edges together over line and straighten edges. When blanket is partially dry, change position and straighten again. When dry, brush up nap with wire or nylon brush.

- Cotton, Rayon and Synthetic Blankets

Wash as recommended for permanent press fabrics.

## **Curtains, Draperies and Slip Covers**

- Be sure fabric is washable, shrink resistant and colorfast before washing.
- Select water temperature and cycle according to type of fabric.
- Shake or vacuum to remove loose dirt.
- Pre-wash or soak if badly soiled.
- Wash small loads. Crowding will cause wrinkling.
- Dry in dryer or on the line.
- Replace slipcovers on furniture while still slightly damp. They will dry to fit tightly.

**IMPORTANT:** Sun-damaged curtains and draperies will tear whether hand or machine washed.

## **Diapers and Baby Clothes**

- Rinse immediately. Soak diapers in a solution of lukewarm water and a small amount of detergent until you are ready to wash them.
- Treat spots and stains before washing.
- Spin excess water from diapers before washing.
- Wash diapers, following the Water Temperature Guide for white cottons on page 7.
- Wash small items in a mesh bag.

**IMPORTANT:** You may wish to use bleach or a special soaking product for soaking diapers. Do not use liquid fabric softener every time. Overuse of fabric softener reduces the absorbency of diapers.

## **Elastics**

- Elastics pick up oil from the body. Since oil damages elastics, wash often to help reduce the damage.
- Use warm enough water and sufficient detergent to remove oils.
- Dry at lowest dryer temperature setting. Remove from dryer while slightly damp.

### Flame Retardant Finishes

Some items may be treated to improve their resistance to burning if exposed to flame. Such items will be clearly labeled.

To help keep flame retardant qualities through continuous use and washing, wash according to the manufacturer's instructions.

### Glass Fiber Materials

**Do not wash glass fiber materials in your washer.** Some fibers can remain in the washer. These glass particles could stick to fabric washed in the next load and cause skin irritation.

### Napped Items

- Corduroy
- Velveteen

1. Use hot or warm water, depending on colorfastness.
2. Turn inside out before washing.
3. Restore fluffiness in your dryer. If line dried, place on hangers to dry and brush up nap.

### Permanent Press Fabrics

Permanent press is a special finish applied to fabrics. It helps the garment stay smooth and wrinkle-free...if it is washed correctly.

When the finish is heated (as in hot water or in the dryer) it softens and becomes pliable. It will give up wrinkles at this time.

Permanent press items should not be crushed while warm (in spin or when dryer stops). Wrinkles will be put back in. Your KitchenAid washer has a special cool down cycle for permanent press to help prevent setting in wrinkles.

1. **Wash frequently.** Permanent press garments stay so fresh looking that people tend to postpone laundering. Once they become soiled and stained they are difficult to wash clean.
2. **Remove stains as soon as possible.** Pretreat stains or heavy

soils with a liquid detergent, a paste made from your regular detergent, or a special pretreatment product.

3. **Sort properly.** Always wash whites in a separate load to prevent color pick-up from other garments.
4. **Wash small loads.** Crowding in the washer can cause wrinkling.
5. **Select wash time and water temperature according to amount of soil.**
6. **Use a cold rinse.**
7. **Add a diluted fabric softener** in deep rinse to reduce the static electricity that attracts lint and makes garments cling.
8. **Follow instructions on the garment's label for proper use of bleach.**
9. **Tumble dry** for best results and **remove load as soon as tumbling stops** to help prevent setting in wrinkles.

### Pillows and Stuffed Toys

- Feather
  - Polyester (if manufacturer suggests machine washing)
  - Foam
1. Be sure pillow covers are securely stitched.
  2. Partially fill washer with water; add detergent; agitate until detergent is dissolved.
  3. Place two pillows in washer on opposite sides of agitator to balance load.
  4. Allow washer to completely fill and continue through cycle.
  5. Stop the washer occasionally to press air from item being washed.

**IMPORTANT:** Washing feather pillows is not recommended unless they are dryer dried.

6. Dry foam rubber items without heat (air dry cycle).

## **⚠ WARNING**

### **Fire Hazard**

**Do not dry foam rubber items on heat setting of dryer. Use air setting or line dry. Drying in a heated dryer can damage items or be a FIRE HAZARD.**

### **Plastic and Rubber Items**

- Shower Curtains
- Table Cloths
- Baby Panties
  - Treat as delicate items.
  - Wash in warm water.
  - Wash small items in a mesh bag.
  - Dry **without heat**.

### **Quilts and Bedspreads**

- Treat quilted items as “delicate items.”
- Wash one quilt or bedspread at a time. Distribute evenly around agitator.
- If dried on a line, shake occasionally; for best results, dry in a dryer.
- Do not wash cotton-filled comforters unless they are quilted or stitched; cotton batting, when only tucked, tends to slip and become lumpy.
- Do not overload. Some items may be too large for the washer.

### **Scatter Rugs**

1. Check label to be sure rug is washable and colorfast.
2. Shake or vacuum well.
3. Pre-wash or soak rug if it is badly soiled.
4. Wash more than one small rug at a time. If you wash only one small rug, add bath towels to balance the load. A larger rug should be distributed around the agitator to balance the load. Remember, for good washing results the rug should move freely during agitation.

### **Snowsuits, Vests, Jackets, Etc.**

- Nylon
- Polyester Base
  - Follow the care label instructions to select the proper water temperature and cycle.
  - Pre-soak items before washing if badly soiled.
  - Wash only one jacket or snowsuit at a time. Load item in washer evenly around the agitator.

**IMPORTANT:** Bulky synthetic items often float on top of the water. Stop the washer from time to time to press air from item being washed.

- Two rinses may be necessary.
- Do not overload. Some items may be too large for the washer.

### **Towels**

Some towels, particularly those made of a blend of synthetic fibers and natural fibers (polyester and cotton blends), may shed more lint than other towels. When towels are laundered, the lint screen in your dryer may get full faster. Be sure to remove the lint from the dryer lint screen when you launder new towels.

### **Tinted, Dyed or Non-Colorfast Items**

For tinting or dyeing in the washer, follow package directions and information on page 21 for best results.

To wash non-colorfast items, follow care label directions to reduce the amount of dye transfer.

**Wash separately.** Clean the washer according to instructions on page 17.

### **Washable Knits**

Knits are comfortable to wear because they stretch and give. However, this "stretchy" factor means they will be less stable than a woven fabric when washed.

When manufactured, some knit fabrics may be stretched. When the garment is washed, the fabric can return to its original size. This is the nature of knits when they are washed...either by hand or washer.

Knits made of synthetic fibers, such as polyester, acrylic and nylons, are more likely to keep their original size than those made of cotton or rayon. Knit garments made of a blend of synthetic fiber and a cellulosic fiber, such as cotton or rayon (at least 50% synthetic fiber in blend), also hold their size better than those of cotton or rayon.

1. Select cycle, wash temperature and time depending upon fiber content, construction of garment, amount of soil and colorfastness.
2. Follow garment manufacturer's recommendations on the care label or hang tag.
3. To prevent snagging, close zippers, fasten hooks and eyes, and turn wrong side out.
4. Sort properly. White synthetic fiber items pick up color readily from other items.
5. Wash small loads to reduce pilling and lint generation on items.

# For Service or Assistance

## Follow These Steps

1. If your washer should fail to operate, review the following list before calling your dealer. You could save the cost of a service call.

### If your washer does not fill:

- Is the power supply cord plugged into a live circuit with the proper voltage?
- Are both water faucets open?
- Has fuse blown, or is the circuit breaker open?
- Are the water supply hoses kinked?

### If your washer does not spin:

- Is the lid closed?
- Is the power supply cord plugged into a live circuit with the proper voltage?
- Has a fuse blown, or is the circuit breaker open?

### If your washer stops during a cycle:

- Remember, the washer pauses briefly between each portion of every cycle. The pauses are normal.

### Make sure the drain hose is higher than the water level in the washer. If it isn't:

- The washer may seem to be draining during wash and rinse cycles.
- Water can siphon out. (See Installation Instructions.)

2. If the problem is not due to one of the above items:\*

- Call KitchenAid Consumer Relations, TOLL-FREE:  
**1-800-422-1230**

and talk with one of our trained consultants. The consultant can instruct you in how to obtain satisfactory operation from your appliance or, if service is necessary, recommend a qualified service company in your area.

- If you prefer, write to:

Consumer Relations Department  
KitchenAid  
P.O. Box 558  
St. Joseph, MI 49085-0558

Please include a daytime phone number in your correspondence.

3. If you need service:\*

- Call your dealer or the repair service he recommends.
- All service should be handled locally by the dealer from whom you purchased the unit or an authorized KitchenAid servicer.
- If you are unable to obtain the name of a local authorized KitchenAid servicer, call our service assistance number (see Step 2).

4. If you are not satisfied with the action taken:\*

- Contact the Major Appliance Consumer Action Panel (MACAP). MACAP is a group of independent consumer experts that voices consumer views at the highest levels of the major appliance industry.
- Contact MACAP only when the dealer, authorized servicer, or KitchenAid have failed to resolve your problem.

Major Appliance Consumer  
Action Panel  
20 North Wacker Drive  
Chicago, IL 60606

- MACAP will in turn inform us of your action.

\*When requesting assistance, please provide: Model Number, Serial Number, Date of Purchase and a complete description of the problem. This information is needed in order to better respond to your request.

# KitchenAid™ Washer Warranty

LENGTH OF WARRANTY:	KITCHENAID WILL PAY FOR:	KITCHENAID WILL NOT PAY FOR:
<b>ONE YEAR FULL WARRANTY</b> FROM DATE OF PURCHASE.	Replacement parts and repair labor costs to correct defects in materials or workmanship. Service must be provided by an authorized KitchenAid servicing outlet.	A. Service calls to: <ol style="list-style-type: none"> <li>1. Correct the installation of the washer.</li> <li>2. Instruct you how to use the washer.</li> <li>3. Replace house fuses or correct house wiring.</li> <li>4. Correct house plumbing.</li> </ol> B. Repairs when washer is used in other than normal home use. C. Damage resulting from accident, alteration, misuse, abuse, improper installation or installation not in accordance with local electrical or plumbing codes. D. Any labor costs during the limited warranties. E. Replacement parts or repair labor costs for units operated outside the United States. F. Pickup and delivery. This product is designed to be repaired in the home.
<b>SECOND YEAR LIMITED WARRANTY</b> FROM DATE OF PURCHASE.	Replacement parts to correct defects in materials or workmanship.	
<b>SECOND THROUGH FIFTH YEAR LIMITED WARRANTY</b> FROM DATE OF PURCHASE.	Replacement parts for the cabinet assembly should it rust through due to defects in materials or workmanship.  For solid state touch control models, replacement parts for the solid state controls if defective in materials or workmanship.	
<b>SECOND THROUGH TENTH YEAR LIMITED WARRANTY</b> FROM DATE OF PURCHASE.	Replacement parts for any part of the gearcase assembly to correct defects in materials or workmanship.  Replacement parts for the washer outer tub should it fail to contain water due to defects in materials or workmanship.	

**KITCHENAID DOES NOT ASSUME ANY RESPONSIBILITY FOR INCIDENTAL OR CONSEQUENTIAL DAMAGES.** Some states do not allow the exclusion or limitation of incidental or consequential damages, so this exclusion or limitation may not apply to you.

This warranty gives you specific legal rights and you may also have other rights which vary from state to state.

If you need service, first see the "Service and Assistance" section of this book. After checking "Service and Assistance," additional help can be found by calling our service assistance telephone number, **1-800-422-1230**, from anywhere in the U.S.

KitchenAid  
St. Joseph, Michigan U.S.A. 49085

TM Trademark of KitchenAid

Part No. 3353727  
©1990 KitchenAid

Printed in U.S.A.