

This Owner's Manual is provided and hosted by [Appliance Factory Parts](http://ApplianceFactoryParts.com).

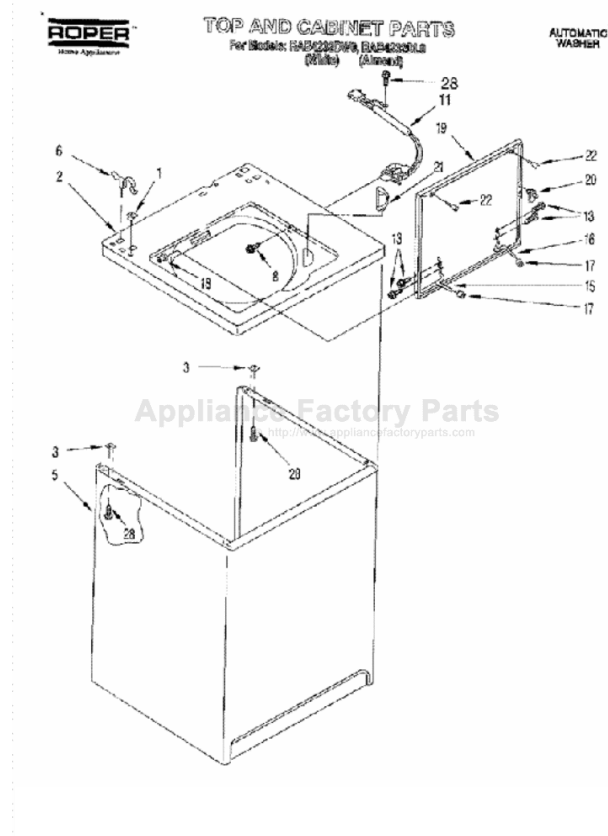

ROPER RAB4232DW0 Owner's Manual

[Shop genuine replacement parts for ROPER
RAB4232DW0](#)



[Find Your ROPER Washer Parts - Select From 140 Models](#)

----- Manual continues below -----



Use And Care

G U I D E



A Note to You	2
Washer Safety	3
Parts and Features	4
Operating Your Washer	5
Caring for Your Washer	9
Laundry Tips	10
Removing Stains	14
Troubleshooting	17
Requesting Assistance or Service	19
Warranty	20

1-800-447-6737

Call us with questions or comments.

TWO SPEED AUTOMATIC WASHER

Part No. 3363550

A Note to You

Thank you for buying a Roper® appliance.

Roper appliances give you all the functionality of name brand appliances at a value price. To ensure you enjoy years of trouble-free operation, we developed this Use and Care Guide. It contains valuable information about how to operate and maintain your appliance properly and safely. Please read it carefully. Also, please complete and mail the Ownership Registration Card provided with your appliance. This card helps us notify you about any new information on your appliance.

Please record your model's information.

Whenever you call to request service on your appliance, you need to know your complete model number and serial number. You can find this information on the model and serial number plate (see diagram on page 4 for location of plate).

Please also record the purchase date of your appliance and your dealer's name, address, and telephone number.

Model Number _____

Serial Number _____

Purchase Date _____

Dealer Name _____

Dealer Address _____

Dealer Phone _____

Keep this book and the sales slip together in a safe place for future reference.

**Call our toll-free number
24 hours a day.**

1-800-447-6737

Washer Safety

Your safety is important to us.

This guide contains safety statements under warning symbols. Please pay special attention to these symbols and follow any instructions given. Here is a brief explanation of the symbol.

WARNING

This symbol alerts you to such dangers as personal injury, burns, fire, and electrical shock.

IMPORTANT SAFETY INSTRUCTIONS

WARNING

To reduce the risk of fire, electrical shock, or injury when using your washer, follow basic precautions including the following:

- Read all instructions before using your washer.
 - Do not machine wash or machine dry items cleaned, washed, soaked in, or spotted with wax, paint, gasoline, oil, or other flammable fluids. The fumes can create a fire hazard or explosion. Always hand wash and line dry items containing these materials.
 - Flammable fluids (dry-cleaning solvents, kerosene, gasoline, etc.) should not be used or stored in or near your washer. Do not add flammable fluids to your wash water. These substances give off vapors that can create a fire hazard or explosion.
 - Do not allow children to operate, play with, or crawl on or inside your washer. Supervise children closely when your washer is used near them.
 - Before your washer is removed from service or discarded, remove the lid to prevent accidental entrapment.
 - After starting a cycle, do not reach into the basket unless the Cycle Control Knob is pushed in and all motion stops.
 - Do not tamper with the controls.
 - If your hot water has not been used recently (usually 2 weeks or longer), hydrogen gases may build up in your water heater and your hot water pipes. **HYDROGEN GAS IS EXPLOSIVE.** To prevent injury or damage, before using your washer, turn on all hot water faucets and allow water to run for several minutes. This will allow gases to escape. Do not smoke or use any open flame near your faucet while it is open.
- Please ...
- Have only a qualified person install, repair, or replace parts on washer.
 - Maintain washer properly.
 - Protect washer from the weather and keep it where the temperature will not fall below freezing.
 - Install and level washer on a floor that can support the weight.*
 - Connect washer to the correct 3-prong outlet, electrical supply, water supply, and drain.*
 - Ground washer properly.*
- *See the Installation Instructions.

– SAVE THESE INSTRUCTIONS –

Understanding your responsibilities

- Store laundry aids and other materials in a cool, dry place where children cannot reach them (in a locked cabinet if possible).
- Read and follow instructions on packages of detergent and laundry aids, especially warnings and precautions.
- Do not wash or dry items that are soiled with vegetable or cooking oil. These items may contain some oil after laundering. Due to the remaining oil, the fabric may smoke or catch fire by itself.
- Do not use chlorine bleach and ammonia or acids (such as vinegar or rust remover) in the same wash. Hazardous fumes can form.
- Unplug power supply cord before attempting to service your washer.
- Do not machine wash fiberglass materials. Small particles can stick to fabrics washed in following loads and cause skin irritation.

Parts and Features

The parts and features of your washer are illustrated on this page. Become familiar with all parts and features before using your washer.

Page references are included next to some features. Refer to those pages for more information about the features.

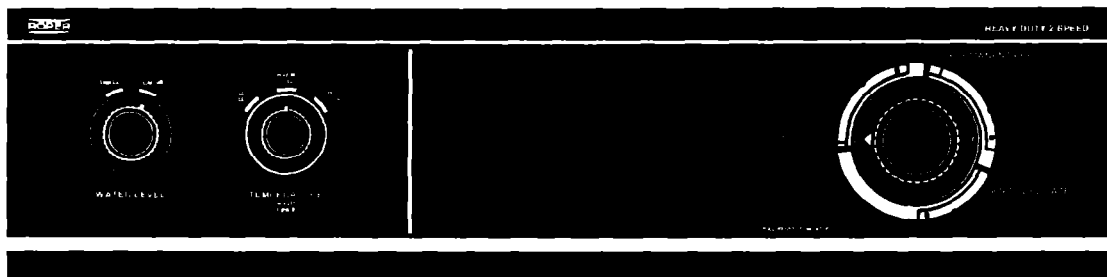
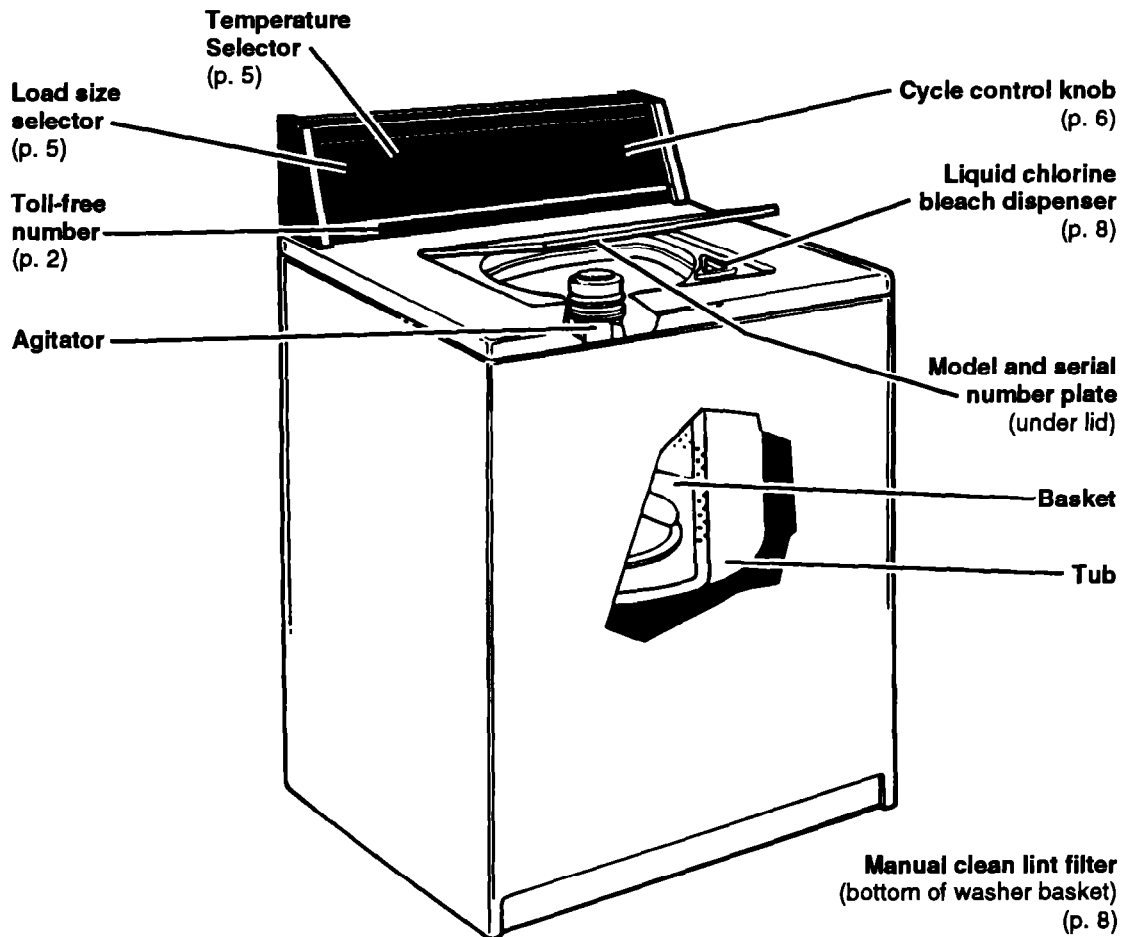

Operating Your Washer

To obtain the best washing results, you must operate your washer properly. This section gives you this important information. Page references are included for more information.

Starting Your Washer

1. **Add measured detergent to the washer. Then place a sorted load of clothes in the washer.**
 - Sort and load clothes as described on page 10.
 - If desired, you may also add color-safe all-fabric bleach.
2. **(OPTIONAL STEP) If desired, add measured liquid chlorine bleach to the liquid bleach dispenser (see page 8).**
 - Use only liquid chlorine bleach in the bleach dispenser.
3. **Close the washer lid.**
4. **Select a load size.**

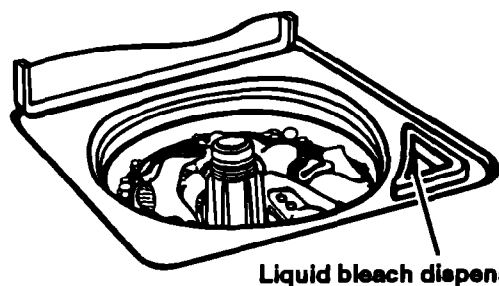

Liquid bleach dispenser

5. **Select a wash-rinse temperature with the Water Temperature Selector. Match the water temperature with the type of fabric and soils being washed. See page 12 for water temperature guidelines.**
 - Three wash-rinse temperatures are available: cold-cold, warm-cold, and hot-cold.



6. **Push In and turn the Cycle Control Knob clockwise to the wash cycle you want (see page 6). Match wash water temperature with the type of fabric and soils being washed.**
7. **Pull out Cycle Control Knob to start washer.**
8. **(OPTIONAL STEP) If desired, add measured and diluted fabric softener during rinse cycle (see page 8).**

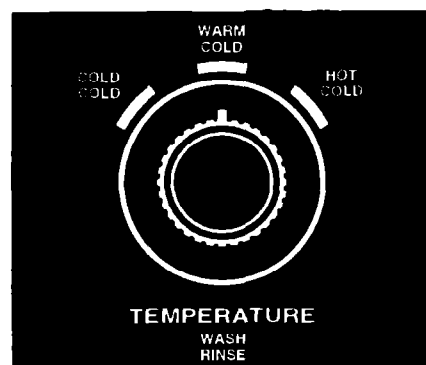

OPERATING YOUR WASHER

Stopping/restarting your washer

If necessary, you can stop your washer during a cycle to add more clothes, or add fabric softener to the final rinse (see page 8).

- To **stop** the washer at any time, push in the Cycle Control Knob.
- To **restart** the washer, close the lid (if necessary) and pull out the Cycle Control Knob.

Selecting a cycle

Use the information in this section to help you make the best cycle selections for your wash loads. Each cycle is designed for different types of fabrics and soil levels.

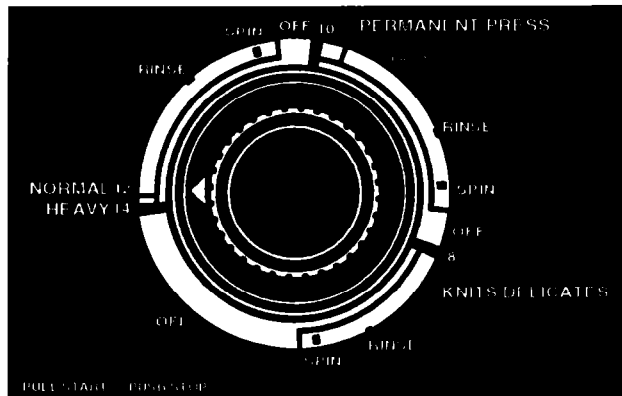

Heavy Cycle

The Heavy cycle features high agitation and spin speeds.

- Use 14 minutes of wash time to clean large loads of heavily constructed fabrics that are moderately to heavily soiled.

Normal Cycle

The Normal cycle features high spin speeds to shorten drying time.

- Use 12 minutes of wash time to clean cotton and linen fabrics that are moderately to heavily soiled.

Permanent Press Cycle

The Permanent Press cycle features a cool-down rinse and low spin speeds to reduce wrinkling.

- Use 10 minutes of wash time to clean permanent press and some synthetic fabrics that are lightly to moderately soiled.
- The washer pauses briefly during the Permanent Press cycle. These pauses are normal for washer operation.

Knits/Delicate Cycle

The Knits/Delicate cycle features a reduced agitation speed for gentle soil removal. Low spin speeds reduce wrinkling.

- Use 8 minutes of wash time to clean delicate items and washable knits that are lightly to moderately soiled.

Using rinse and spin

When using extra detergent for heavily soiled clothes, or washing special-care items, you may want an extra rinse and spin.

1. Push in Cycle Control Knob and turn clockwise until indicator points to RINSE, as illustrated.
2. Pull out Cycle Control Knob. The washer fills to selected load size, agitates, drains, and spins.

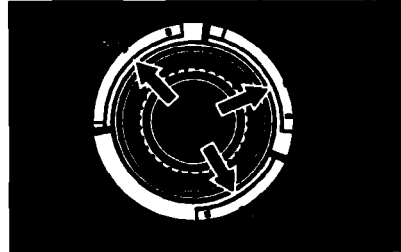

Using drain and spin

A drain and spin may help shorten drying times for some heavy fabrics or special-care items by removing excess water.

1. Push in Cycle Control Knob and turn clockwise until indicator points to SPIN, as illustrated.
2. Pull out Cycle Control Knob. The washer drains and then spins.

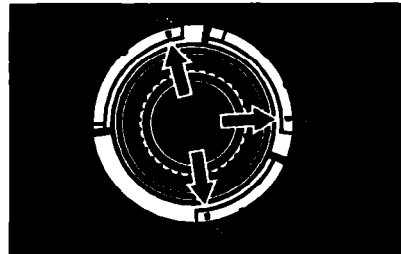

What happens in each cycle

When the Cycle Control Knob is set to a number and pulled out, the washer fills (to the selected load size) before agitation and timing start. The washer begins agitating immediately after filling; agitation can occur with the washer lid up or down.

After agitation starts, the Cycle Control Knob turns clockwise until it points to an OFF area and the cycle ends.

The washer pauses briefly during the Permanent Press cycle. These pauses are normal for washer operation.

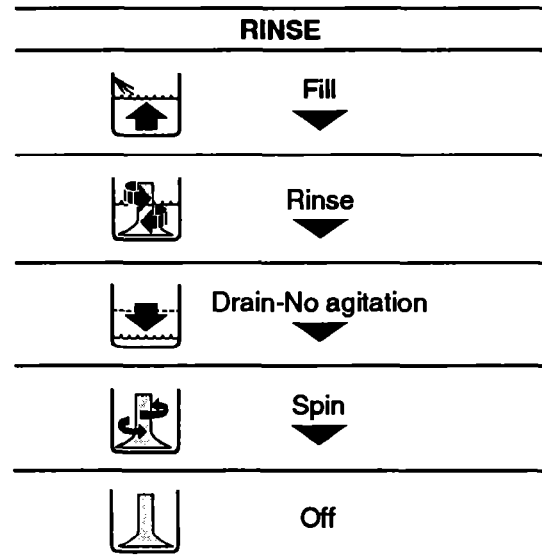
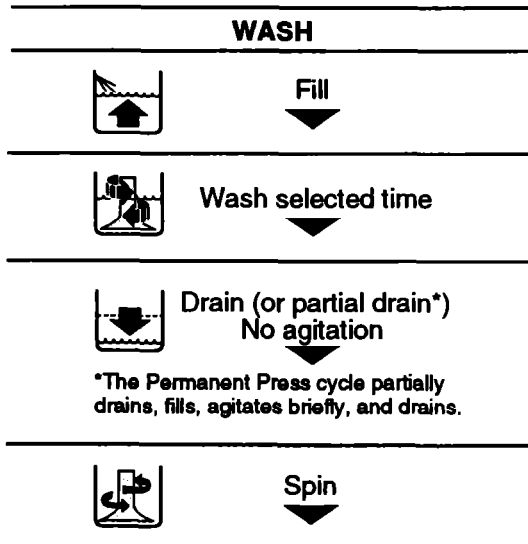

OPERATING YOUR WASHER

Using the liquid chlorine bleach dispenser

Always measure liquid chlorine bleach. Do not guess. Never use more than 1 cup (250 mL) for a full load. Use less with lower water level settings. Follow manufacturer's directions for safe use. Use a cup with a pouring spout to avoid spilling.

1. Load the washer.
2. Pour measured chlorine bleach carefully into the dispenser. Do not let bleach splash, drip, or run down into washer basket. Undiluted bleach will damage any fabric it touches.
3. Start the washer. Bleach will be diluted and dispensed automatically during wash part of cycle.

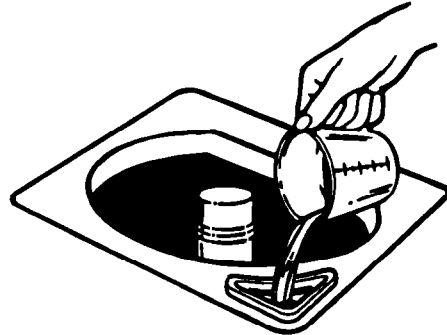

NOTE: Do not use this dispenser to add powdered chlorine or all-fabric bleach to your wash load. The dispenser is for liquid chlorine bleach use only.

Adding fabric softeners

- Always dilute fabric softeners with $\frac{1}{2}$ to 1 cup (125 to 250 mL) warm water. Undiluted fabric softener can stain fabrics.
- Add diluted fabric softener only in the final rinse.
- Fabric softeners should not be mixed with other laundry products because greasy stains may form. If stains form, remove by wetting the stain and rubbing with liquid detergent or a bar of soap. Rewash the stained item.
- Too much fabric softener can make some items (diapers and towels) nonabsorbent. If this happens, use less fabric softener or do not use it every time.

Manual clean lint filter

Clean the filter at the bottom of the agitator after every load for the best filtering results.

To clean:

1. Lift off the agitator barrel.
2. Wash or wipe the filter clean in the bottom of the agitator barrel. The filter is not removable.
3. Replace agitator barrel and snap into place.

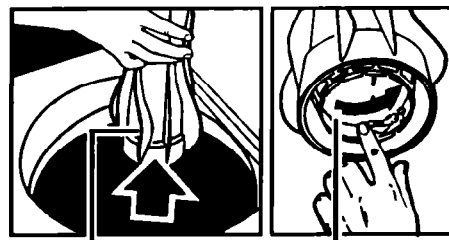

Agitator barrel

Manual clean lint filter

Caring for Your Washer

Proper care of your washer can extend its life. This section explains how to care for your washer properly and safely.

Cleaning your washer

Exterior



Wipe up detergent, bleach, and other spills with a soft, damp cloth or sponge as they occur. Occasionally wipe the outside of the washer to keep it looking like new.



Do not put sharp or metal objects in your washer. They can damage the finish. Check all pockets for pins, clips, money, bolts, nuts, etc.

Do not lay these objects on your washer after emptying pockets.

Interior

Clean interior with 1 cup (250 mL) of chlorine bleach mixed with 2 cups (500 mL) of detergent. Run washer through a complete cycle using hot water. Repeat process if necessary.

NOTE: Remove hard water deposits using only cleaners labeled as washer safe.

Winter storage or moving care

Install and store your washer where it will not freeze. Because some water may stay in the hoses, freezing can damage your washer. If storing or moving your washer during freezing weather, winterize it.

To winterize washer:

1. Shut off both water faucets.
2. Disconnect and drain water inlet hoses.
3. Put 1 quart (1L) of R.V.-type antifreeze in the basket.
4. Run washer on a drain and spin setting (see page 7) for about 30 seconds to mix the antifreeze and water.
5. Unplug the power supply cord.

To use washer again:

1. Flush water pipes and hoses.
2. Reconnect water inlet hoses.
3. Turn on both water faucets.
4. Reconnect power supply cord.
5. Run the washer through a complete cycle with 1 cup (250 mL) of detergent to clean out antifreeze.

Non-use or vacation care

You should operate your washer only when you are at home. If you will be on vacation or will not be using your washer for an extended period of time, you should:

- Unplug the power supply cord or turn off electrical power to the washer.
- Turn off the water supply to the washer. This helps avoid accidental flooding (due to a water pressure surge) while you are away.

Laundry Tips

This section reviews proper laundering techniques and gives you additional washing information.

Preparing clothes for washing

- Close zippers, snaps, and hooks to avoid snagging other items.



Remove pins, buckles, and other hard objects to avoid scratching the washer interior. Remove non-washable trim and ornaments.

- Empty pockets and turn them inside out.
- Turn down cuffs, brush away lint and dirt.

- Turn synthetic knits inside out to avoid pilling.
- Tie strings and sashes so they will not tangle.
- Mend tears, loose hems, and seams.
- Treat spots and stains. (See "Removing Stains" on pages 14-16.)
- Stained or wet garments should be washed promptly for best results.

Sorting

- Separate heavily-soiled items from lightly-soiled ones, even if they would normally be washed together. Separate lint givers (towels, chenille) from lint takers (corduroy, synthetics,



permanent press). When possible, turn lint givers inside out.

- Separate dark colors from light colors, colorfast items from noncolorfast items.
- Sort by fabric and construction (sturdy cottons, knits, delicate items).

Loading

- Drop items into washer loosely. Fill to the top of the basket, but do not wrap items around the agitator. Items should move easily through wash water for best cleaning and wrinkle-free results. Items should sink and reappear later.



- Load washer properly and select correct load size setting. Overloading or packing the machine, and selecting a setting too small for the wash load can:
 - cause poor cleaning.
 - increase wrinkling.
 - create excessive lint.
 - wear out items faster (because of pilling).

- Load by the amount of space items take up, not by their weight.

- Mix large and small items in each load.



Load evenly to maintain washer balance. An off-balance load can make the washer vibrate during spin.

- To reduce wrinkling, permanent press clothes and some synthetic knits should have more room to move in the water than heavy items (towels, jeans). Use the large load setting for best results with permanent press clothes.

Loading suggestions

For these suggested full-sized loads, set the Load Size Selector to the highest water level setting.

LARGE CAPACITY WASHERS			
Heavy Work Clothes 2 pair pants 3 shirts 3 pair jeans 1 coverall	Permanent Press 1 double sheet 1 tablecloth 1 dress 1 blouse 2 slacks 3 shirts 2 pillowcases	Mixed Load 2 double or 1 king size sheet(s) 4 pillowcases 6 T-shirts 6 pair shorts 2 shirts 2 blouses 6 handkerchiefs	Towels 8 bath towels 8 hand towels 10 wash cloths 1 bathmat Delicates 2 camisoles 4 slips 4 panties 2 bras 2 nighties
Knits 2 slacks 2 blouses 4 shirts 4 tops 2 dresses			

Saving energy

- Use warm or cold wash water for most loads. Use hot water only when washing heavy, greasy soils or whites.
- Use cold rinses.
- Wash full loads.
- Use lower water levels when washing small loads.
- Avoid rewashing. Use enough detergent and pretreat stains or heavy soils. Use the cycles and wash times recommended for the fabric and soil.
- Use your washer during off-peak hours – usually early morning and late evening. (Ask your power company.)

Water Guidelines

Selecting water temperatures

WASH WATER TEMPERATURE*	SUGGESTED FABRICS	COMMENTS
HOT 130°F (54°C) or above	<ul style="list-style-type: none"> • Work clothes • Sturdy whites/colorfast pastels • Diapers 	<ul style="list-style-type: none"> • Best cleaning for heavily soiled items • Removes oils, perspiration, greasy soils, and stains • Prevents graying or yellowing
WARM 90°-110°F (32°-44°C)	<ul style="list-style-type: none"> • Dark/noncolorfast colors • Permanent press items • Nylon, polyester, acrylics, silks, woolens • Knits/delicate fabrics 	<ul style="list-style-type: none"> • Best for lightly soiled to moderately soiled items • Safe for most fabric finishes • Less fading and dye bleeding • Reduces wrinkling
COLD 70°-90°F (21°-32°C)	<ul style="list-style-type: none"> • Extra-sensitive colors • Noncolorfast items • Hand washables 	<ul style="list-style-type: none"> • Best for very lightly soiled items • Saves hot water • Best rinse water temperature

* The washer features cold rinses for all wash temperatures.

Checking hot water temperature

Your hot water should be 130°F (54°C) or above. If you do not know your hot water temperature, you can check it easily. You may need to raise the temperature of your water heater. To check your hot water:

1. Fill a pan with the hottest water available from the faucet that fills your washer.
NOTE: If you do not have a faucet at your washer site, collect the water from the faucet closest to your washer.
2. Place a candy thermometer or cooking thermometer in the water to check the temperature.

NOTE: In wash water temperatures colder than 70°F (21°C), detergents do not dissolve well. Also, soils may be difficult to remove, and some fabrics may retain wear wrinkles and may have increased pilling.

Water hardness

Many poor washing results can be traced to the hardness of the wash water. To check your water hardness:

- City water – ask the city water company.
- Well water – ask the local water authority.

Ask for the mineral content in grains/gallon or parts/million. If your water is more than 8 grains/gallon or more than 153 parts/million, you should consider:

- Installing a water softener.
- Using more detergent.
- Using a packaged water conditioner.
- Not using soap.

Washing special-care items

Most garments and household textiles have care labels with laundering instructions. **Always follow care label directions when they are available.** Below are general washing instructions for some special washables.

ITEM	CARE INSTRUCTIONS
Blankets (electric or woolen)	Pretreat spots and stains. Select water temperature, cycle, and time according to the type of blanket being washed. An extra rinse may be necessary (see page 7 for rinse and spin information). Check care label to see if manufacturer recommends machine washing.
Curtains, drapes, slipcovers	Wash small loads. Crowding may cause wrinkling. Replace slipcovers while still slightly damp. They will dry to fit tightly. NOTE: Sun-damaged curtains and draperies will tear whether hand or machine washed.
Diapers	When using chlorine bleach for soaking, add extra detergent to the load. Avoid overuse of fabric softeners – absorbency will be reduced.
Elastic, spandex	Elastic picks up oil from the body. Oil can damage elastic. Wash often to reduce the damage. Use warm water and sufficient detergent to remove oils. Do not use chlorine bleach.
Flame-retardant clothing	Items will be clearly labeled as flame-retardant. Follow manufacturer's instructions to retain flame-retardant qualities.
Knits	Knits are comfortable to wear because they stretch. However, this means that knits are more likely to be stretched and damaged when washed (especially bulky knits). Knits made of synthetic fabrics such as polyester, nylon, and acrylic tend to keep their original shape more than a knit made of cotton or ramie.
Pillows, stuffed toys	Washing feather pillows is not recommended unless they will be dried in a dryer.
Plastic, rubber items	Treat as delicate items. Wash in warm water. Wash small items in a mesh bag.
Quilts, bedspreads	Do not wash cotton-filled comforters unless they are quilted or stitched. Tucked cotton batting tends to slip and become lumpy. An extra rinse may be necessary.
Scatter rugs	Shake or vacuum rugs to remove loose dirt. Wash more than one rug at a time. If washing only one rug, add bath towels to balance the load.
Snowsuits, jackets	Wash only one or two items at a time. You may need to stop the washer occasionally to press air from the items being washed. An extra rinse may be necessary.

Removing Stains

Stained, heavily-soiled, or greasy items may need to be prewashed or soaked for best results. Soaking helps remove protein-type stains like blood, milk, or grass. Prewashing helps loosen soil before washing.

Stain removal rules

- Use warm water for soaking or prewashing stained laundry. Hot water can set stains.
- Most stains are easier to remove when they are fresh. Old or set stains may not come out. Follow package directions for pretreatment products.
- Before treating any stain, find out what kind of stain it is, how old the stain is, what kind of fabric it is, and if the fabric is colorfast. (Check the care label.)
- Washing and drying can set some stains.
- Start with cold or warm water. Hot water can set some stains.
- When bleach is recommended, use a bleach that is safe for the fabric.
- Test stain removers on an inside seam or hidden corner of the item to see if the color is removed.
- Put the stained area face down on a paper towel or white cloth. Apply the stain remover to the back of the stain. This forces the stain off the fabric instead of through it.
- Meat tenderizer or enzyme presoaks help break down some protein stains so they are easier to remove.

Stain removal guide

STAIN	TO REMOVE
Alcoholic beverage	These stains turn brown with age, so treat immediately. Sponge or soak fresh stains with cold water. Wash. If stain remains, soak 15 minutes in a solution of lukewarm water, liquid detergent, and a few drops of white vinegar. Rinse. Wash.
Blood	Rinse immediately or soak in cold water with enzyme presoak for 30 minutes or longer. Rinse. Rub detergent into any remaining stains. Rinse. If stain remains, put a few drops of 3% hydrogen peroxide on stain for 3-5 minutes. Rinse thoroughly. Wash.
Chewing gum	Use ice to make gum hard. Scrape off what you can. Sponge with a nonflammable fabric cleaner. Let dry. Wash.
Chocolate or coffee	Sponge immediately with a nonflammable fabric cleaner or apply a prewash soil and stain remover. Rinse. Wash. If stain remains, apply a liquid detergent to stain or soak in warm water with an enzyme presoak. Rewash.
Crayon and candle wax	Scrape off excess with a dull knife. Place fabric between two blotters or facial tissue. Press with warm iron. Remove color stain with nonflammable fabric cleaner. Hand wash until stain is gone. If full load is crayon stained, take to cleaners or coin-operated dry cleaning machine.
Cream, milk, or ice cream	Sponge with a nonflammable fabric cleaner, or a prewash soil and stain remover. Rinse. Wash. Repeat if necessary. If stain remains, apply a few drops of liquid detergent and a few drops of ammonia. Blot dry and rinse. If stain remains, soak in an enzyme presoak. Wash.

REMOVING STAINS

STAIN	TO REMOVE
Deodorants and anti-perspirants	<p>Light stain: Treat with liquid detergent or your regular laundry detergent. Wash in hottest water safe for fabric.</p> <p>Heavy stain: Place face down on towel and treat with a paste of ammonia and all-fabric bleach. Let stand for 30 minutes. Wash in hottest water safe for fabric.</p>
Fat, grease, or oil	<p>Items soiled with vegetable or cooking oil should not be washed or dried. See vegetable/cooking oil Warning on page 3. For other types of greasy stains, use one of the methods below:</p> <ul style="list-style-type: none"> • Use pretreatment stain remover. Follow label directions. Wash in hottest water safe for fabric. • Use talcum powder to absorb as much grease as possible. Sponge with a nonflammable fabric cleaner. Rinse. Wash. • Treat with liquid detergent or rub a detergent paste on the stain. Wash using hottest water safe for fabric.
Fruit stains	<p>Fresh stains: Soak immediately in cool water. Wash. If stain remains, cover area with a paste made of all-fabric bleach, a few drops of hot water and a few drops of ammonia. Wait 15 to 30 minutes. Wash.</p> <p>Old stains: Sponge with white vinegar. Rinse. Repeat procedure for fresh stains.</p>
Grass or green vegetables	<p>Soak in warm or cold water with an enzyme presoak for at least 30 minutes, or sponge with denatured alcohol. Wash in water temperature and bleach safe for the fabric. For colored fabrics, check colorfastness before applying alcohol. For acetate, sponge with a nonflammable fabric cleaner. If stain remains, bleach with 3% hydrogen peroxide. Rinse. Rewash.</p>
Ink or ballpoint pen ink	<p>Spray stain with an aerosol hair spray or rubbing alcohol. Sponge stain continuously until all bleeding stops. Let dry. Repeat if necessary. Wash. If stain remains, bleach if safe for fabric. (India and other indelible inks are almost impossible to remove completely.)</p>
Iron or rust	<p>Colored or noncolorfast items: Apply lemon juice and salt. Place in the sun to dry. Rinse thoroughly. Repeat if necessary.</p> <p>White or colorfast items: Try a rust remover. Test first on inside seam or hem. Some rust removers are not washer safe. Follow package directions.</p>
Ketchup or tomato products	<p>Sponge immediately with a nonflammable fabric cleaner or apply a prewash soil and stain remover. Rinse. Wash. If stain remains, apply a liquid detergent to stain or soak in warm water with an enzyme presoak. Rewash.</p>
Lipstick	<p>Apply nonflammable fabric cleaner or prewash soil and stain remover. Blot with absorbent material. Repeat if necessary. Rinse. If stain still remains, rub with liquid detergent. Wash.</p>

continued on next page

REMOVING STAINS

STAIN	TO REMOVE
Meat juice, egg	Scrape off excess with a dull knife. Soak in cold or warm water with enzyme presoak at least 30 minutes, or treat stains with a nonflammable fabric cleaner. Wash.
Mildew	Wash in hottest water safe for fabric. If stain remains, soak in warm water and an all-fabric bleach for 15 to 30 minutes. Rewash. (Old mildew stains are almost impossible to remove. Mildew fungus destroys or weakens fabrics.) An alternative to bleach is to treat with salt and lemon juice and dry in direct sunlight. Rinse and rewash. Mildew may form if wet or damp laundry remains in your washer for extended periods of time. To prevent mildew, promptly dry laundry after washing.
Mustard	Treat immediately. Scrape off excess mustard. Sponge with a nonflammable fabric cleaner or a prewash soil and stain remover. Rinse. Work liquid detergent and a few drops of vinegar into stain. Rinse. If stain remains, apply 3% hydrogen peroxide. Rinse and wash.
Paint	Hand wash paint-stained items. Water base: Treat stains while still wet. (These paints cannot be removed after they have dried.) Rinse in warm water to flush out paint. Sponge with a nonflammable fabric cleaner. Rinse. Wash. Oil base: Scrape off fresh paint. Sponge with a nonflammable fabric cleaner or treat stain with recommended thinner. While stain is still wet with solvent, rub liquid detergent into it. Wash with hottest water safe for fabric.
Perspiration	Remove stains before ironing. Perspiration stains may weaken fabric. Wash or sponge stain thoroughly with detergent and warm water. If perspiration has changed the color of the fabric, use one of the following treatments: Fresh stains: Apply ammonia to stain. Rinse. Launder to remove ammonia odor. Old stains: Apply white vinegar to stain. Rinse. Launder to remove vinegar odor.
Scorch	Severe scorch cannot be removed. Wet stain with 3% hydrogen peroxide. Cover with a dry cloth and press with an iron as hot as is safe for fabric. Rinse well. Wash. OR Wet with lemon juice and spread in the sun to dry. Wash.
Soft drinks	Sponge immediately with cold water and alcohol. Heat and detergent may set stain.

Requesting Assistance or Service

Before calling for assistance or service, please check "Troubleshooting" on pages 17-18. It may save you the cost of a service call. If you still need help, follow the instructions below.

1. If you need assistance* ...

Call our toll-free number. Dial toll-free from anywhere in the U.S.A.:

1-800-44-ROPER
1-800-447-6737



and talk with one of our trained consultants. The consultant can instruct you in how to obtain satisfactory operation from your appliance or, if service is necessary, recommend a qualified service company in your area.

If you prefer, write to:

Mr. William Clark
Consumer Assistance Representative
Whirlpool Corporation
2000 North M-63
Benton Harbor, MI 49022-2692

Please include a daytime phone number in your correspondence.

2. If you need service* ...

Contact the dealer from whom you purchased the appliance or the authorized servicer in your area. For help finding an authorized servicer in your area, call our toll-free telephone number in Step 1.



*When asking for help or service:

Please provide a detailed description of the problem, your appliance's complete model and serial numbers, and the purchase date. (See page 2.) This information will help us respond properly to your request.

3. If you need FSP® replacement parts ...

FSP is a registered trademark of Whirlpool Corporation for quality parts. Look for this symbol of quality whenever you need a replacement part for your Roper® appliance. FSP replacement parts will fit right and work right, because they are made to the same exacting specifications used to build every new Roper appliance.

To locate FSP replacement parts in your area, refer to Step 2 or call our toll-free number in Step 1.

4. If you are not satisfied with how the problem was solved ...

- Contact the Major Appliance Consumer Action Panel (MACAP). MACAP is a group of independent consumer experts that voices consumer views at the highest levels of the major appliance industry.
- Contact MACAP only when the dealer, authorized servicer, and Whirlpool have failed to resolve your problem.

Major Appliance Consumer Action Panel
20 North Wacker Drive
Chicago, IL 60606

- MACAP will in turn inform us of your action.

TROUBLESHOOTING

Common washer problems

Before calling for service, check these:



Is the power cord firmly plugged into a live outlet with proper voltage?



Have you blown a household fuse or tripped a circuit breaker? Has a time-delay fuse been used?



Are both the hot and cold water faucets turned on?



Are the water hoses kinked or clogged?

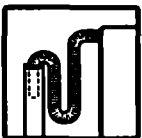

Is the drain hose lower than the water level in the washer? It must be higher.

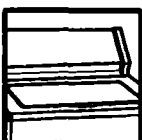

Is the lid closed?



Is the Cycle Control Knob set and pulled out?



Is the washer making noises or vibrating?

Is the wash load properly distributed around the agitator?

NOTE: Washer stops briefly during a wash cycle. These pauses are normal.

If none of these items was causing your problem, see "Requesting Assistance or Service" on page 19.

Requesting Assistance or Service

Before calling for assistance or service, please check "Troubleshooting" on pages 17-18. It may save you the cost of a service call. If you still need help, follow the instructions below.

1. If you need assistance* ...

Call our toll-free number. Dial toll-free from anywhere in the U.S.A.:

1-800-44-ROPER
1-800-447-6737



and talk with one of our trained consultants. The consultant can instruct you in how to obtain satisfactory operation from your appliance or, if service is necessary, recommend a qualified service company in your area.

If you prefer, write to:

Mr. William Clark
Consumer Assistance Representative
Whirlpool Corporation
2000 North M-63
Benton Harbor, MI 49022-2692

Please include a daytime phone number in your correspondence.

2. If you need service* ...

Contact the dealer from whom you purchased the appliance or the authorized servicer in your area. For help finding an authorized servicer in your area, call our toll-free telephone number in Step 1.



*When asking for help or service:

Please provide a detailed description of the problem, your appliance's complete model and serial numbers, and the purchase date. (See page 2.) This information will help us respond properly to your request.

3. If you need FSP® replacement parts ...

FSP is a registered trademark of Whirlpool Corporation for quality parts. Look for this symbol of quality whenever you need a replacement part for your Roper® appliance. FSP replacement parts will fit right and work right, because they are made to the same exacting specifications used to build every new Roper appliance.

To locate FSP replacement parts in your area, refer to Step 2 or call our toll-free number in Step 1.

4. If you are not satisfied with how the problem was solved ...

- Contact the Major Appliance Consumer Action Panel (MACAP). MACAP is a group of independent consumer experts that voices consumer views at the highest levels of the major appliance industry.
- Contact MACAP only when the dealer, authorized servicer, and Whirlpool have failed to resolve your problem.

Major Appliance Consumer Action Panel
20 North Wacker Drive
Chicago, IL 60606

- MACAP will in turn inform us of your action.

ROPER®

Automatic Washer Warranty

LENGTH OF WARRANTY	WE WILL PAY FOR
FULL ONE-YEAR WARRANTY (from date of purchase)	Replacement parts and repair labor to correct defects in materials or workmanship. Service must be provided by an authorized Roper service company.
LIMITED 2ND-5TH YEAR WARRANTY (from date of purchase)	Replacement parts for any part of the gearcase assembly if defective in materials or workmanship.
WE WILL NOT PAY FOR	
<p>A. Service calls to:</p> <ol style="list-style-type: none"> 1. Correct the installation of your washer. 2. Instruct you how to use your washer. 3. Replace house fuses or correct house wiring or plumbing. <p>B. Repairs when your washer is used in other than normal, single-family household use.</p> <p>C. Pickup and delivery. Your washer is designed to be repaired in the home.</p> <p>D. Damage to your washer caused by accident, misuse, fire, flood, acts of God, or use of products not approved by us.</p> <p>E. Any labor costs during the limited warranty.</p> <p>F. Repairs to parts or systems caused by unauthorized modifications made to the appliance.</p>	

6/94

This Roper appliance is warranted by Whirlpool Corporation. Under no circumstances shall it be liable under this warranty for incidental or consequential damages. Some states do not allow the exclusion or limitation of incidental or consequential damages, or limitation of implied warranties, so these limitations or exclusions may not apply to you.

This warranty gives you specific legal rights, and you may also have other rights which vary from state to state.

Outside the United States, a different warranty may also apply. For details, please contact your authorized Roper distributor or military exchange.

If you need service, first see the "Requesting Assistance or Service" section of this book and then, if you need additional help, call our toll-free telephone number, **1-800-44-ROPER (1-800-447-6737)**, from anywhere in the U.S.A.



Printed on recycled paper -
10% post-consumer waste
50% recovered materials

PART NO. 3363550

© 1995 Whirlpool Corporation

© Registered Trademark of Whirlpool, U.S.A.

Printed in U.S.A.