

This Owner's Manual is provided and hosted by [Appliance Factory Parts](http://ApplianceFactoryParts.com).

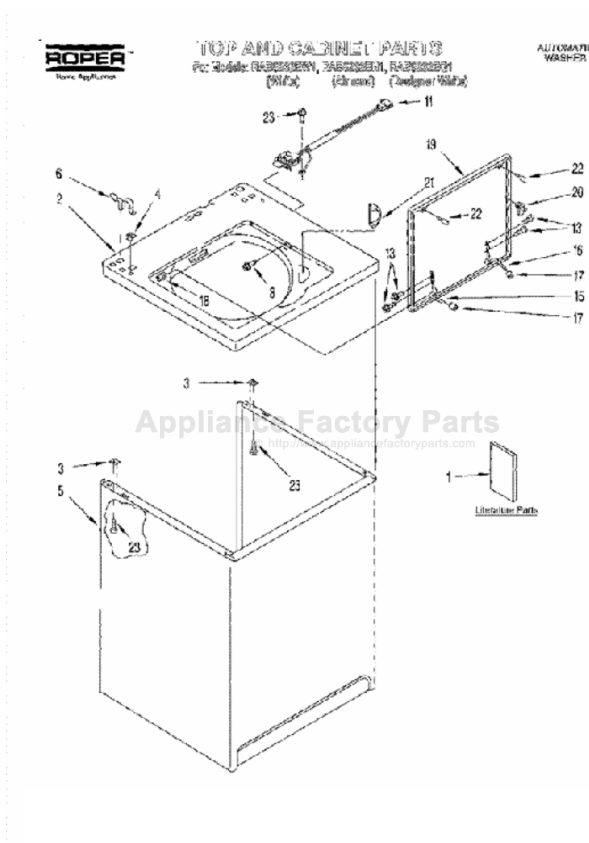

# ROPER RAB5232EN1 Owner's Manual

[Shop genuine replacement parts for ROPER  
RAB5232EN1](#)



[Find Your ROPER Washer Parts - Select From 140 Models](#)

----- Manual continues below -----



# Use And Care

## G U I D E

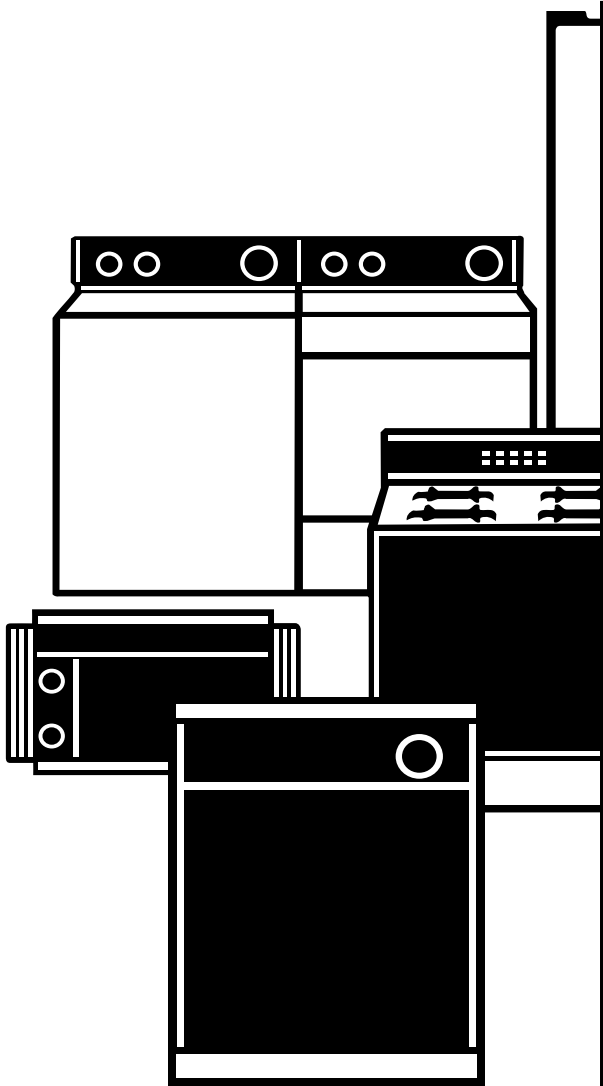

<b>A Note to You</b> .....	2
<b>Washer Safety</b> .....	3
<b>Parts and Features</b> .....	4
<b>Operating Your Washer</b> .....	5
Starting your washer .....	5
Stopping/restarting your washer .....	6
Selecting a cycle and time .....	7
Self-cleaning lint filter .....	8
Understanding what happens in each cycle .....	9
Understanding normal washer sounds .....	9
Adding liquid chlorine bleach .....	10
Adding liquid fabric softener .....	10
<b>Caring for Your Washer</b> .....	11
<b>Laundry Tips</b> .....	12
<b>Removing Stains</b> .....	16
<b>Troubleshooting</b> .....	19
<b>Requesting Assistance or Service</b> .....	21
<b>Warranty</b> .....	24

**1-800-447-6737**

Call us with questions or comments.

### TWO SPEED AUTOMATIC WASHERS

PART NO. 3950305

# A Note to You

## Thank you for buying a ROPER® appliance.

ROPER appliances give you all the functionality of name brand appliances at a value price. To ensure you enjoy years of trouble-free operation, we developed this Use and Care Guide. It contains valuable information about how to operate and maintain your appliance properly and safely. Please read it carefully. Also, please complete and mail the Ownership Registration Card provided with your appliance. This card helps us notify you about any new information on your appliance.

## Please record your model's information.

Whenever you call to request service on your appliance, you need to know your complete model number and serial number. You can find this information on the model and serial number plate (see diagram on page 4 for location of plate).

Please also record the purchase date of your appliance and your dealer's name, address, and telephone number.

Model Number \_\_\_\_\_

Serial Number \_\_\_\_\_

Purchase Date \_\_\_\_\_

Dealer Name \_\_\_\_\_

Dealer Address \_\_\_\_\_

Dealer Phone \_\_\_\_\_

**Keep this book and the sales slip together in a safe place for future reference.**

**Call our toll-free number.**

**1-800-447-6737**

# Washer Safety

## Your safety is important to us.

This guide contains safety statements under warning symbols. Please pay special attention to these symbols and follow any instructions given. Here is a brief explanation of the symbol.



This symbol alerts you to hazards such as fire, electrical shock, or other injuries.

### IMPORTANT SAFETY INSTRUCTIONS

**WARNING** – To reduce the risk of fire, electric shock, or injury to persons when using the washer, follow basic precautions, including the following:

- Read all instructions before using the washer.
- Do not wash articles that have been previously cleaned in, washed in, soaked in, or spotted with gasoline, dry-cleaning solvents, or other flammable or explosive substances as they give off vapors that could ignite or explode.
- Do not add gasoline, dry-cleaning solvents, or other flammable or explosive substances to the wash water. These substances give off vapors that could ignite or explode.
- Under certain conditions, hydrogen gas may be produced in a hot water system that has not been used for 2 weeks or more. **HYDROGEN GAS IS EXPLOSIVE.** If the hot water system has not been used for such a period, before using a washing machine, turn on all hot water faucets and let the water flow from each for several minutes. This will release any accumulated hydrogen gas. As the gas is flammable, do not smoke or use an open flame during this time.
- Do not allow children to play on or in the washer. Close supervision of children is necessary when the washer is used near children.
- Before the washer is removed from service or discarded, remove the door.
- Do not reach into the washer if the tub or agitator is moving.
- Do not install or store the washer where it will be exposed to the weather.
- Do not tamper with controls.
- Do not repair or replace any part of the washer or attempt any servicing unless specifically recommended in this Use and Care Guide or in published user-repair instructions that you understand and have the skills to carry out.
- See Installation Instructions for grounding requirements.

– SAVE THESE INSTRUCTIONS –

# Parts and Features

The parts and features of your washer are illustrated on this page. Become familiar with all parts and features before using your washer. Page references are included next to some features. Refer to those pages for more information about the features.

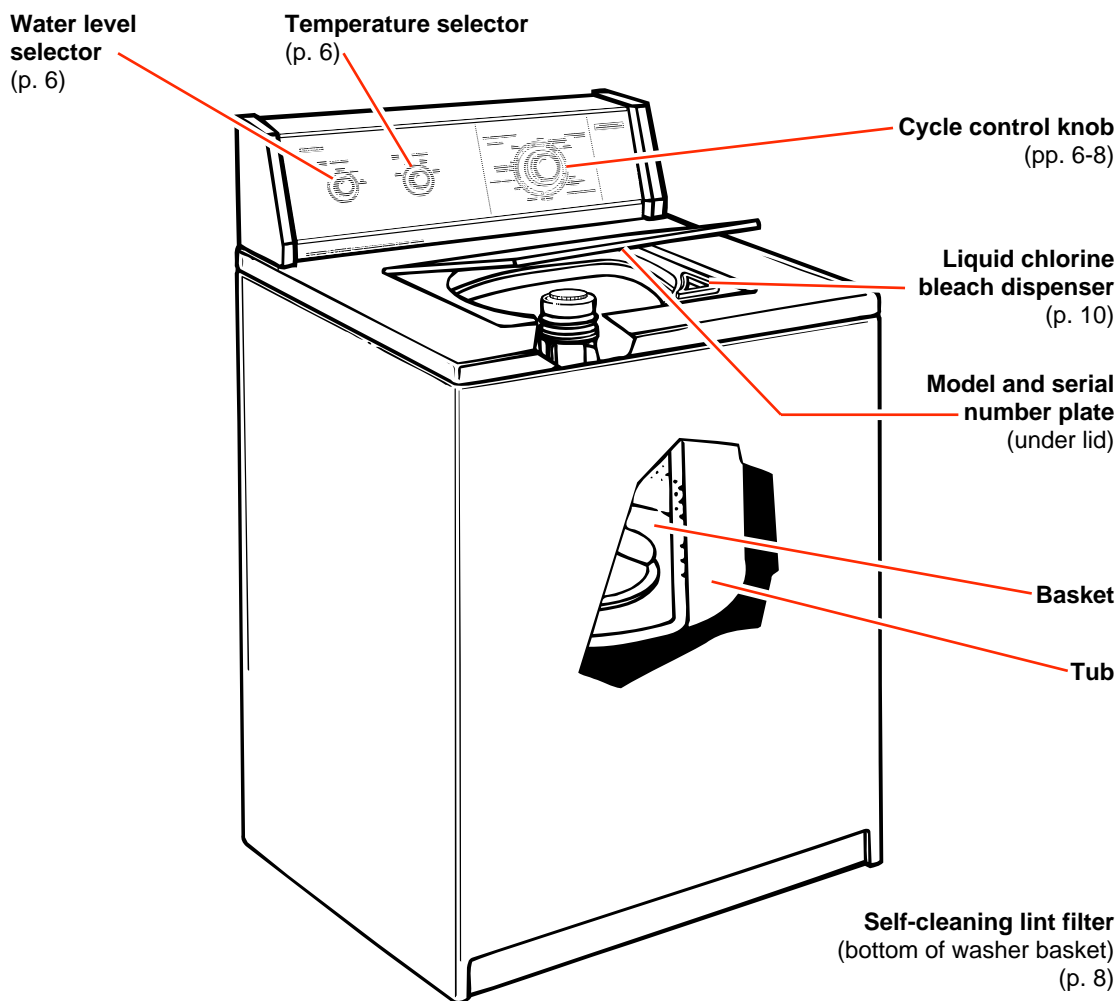

# Operating Your Washer

To obtain the best washing results, you must operate your washer properly. This section gives you this important information. Page references are included for more information.

## ⚠️ WARNING



### Explosion Hazard

Never place items in the washer that are dampened with gasoline or other flammable fluids.

Do not wash or dry items soiled with vegetable or cooking oils because they may contain some oil after laundering.

Doing so can result in death, explosion, or fire.

## ⚠️ WARNING



### Electrical Shock Hazard

Plug into a grounded 3 prong outlet.

Do not remove ground prong.

Do not use an adapter.

Failure to follow these instructions can result in death or electrical shock.

## Starting your washer

- 1. Add measured detergent to the washer. Then place a sorted load of clothes in the washer.**
  - Sort and load clothes as described on pages 12-13.
  - If desired, you may also add color safe bleach.
- 2. (OPTIONAL STEP) If desired, pour measured liquid chlorine bleach into the bleach dispenser. See page 10.**
  - Use only liquid chlorine bleach in the bleach dispenser.
- 3. Close the washer lid.**

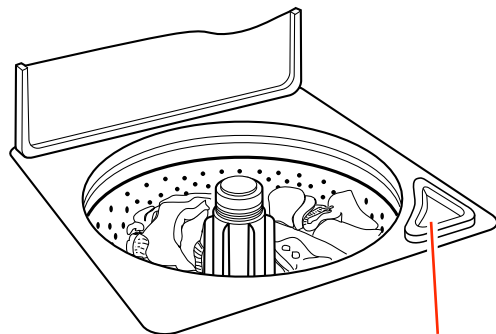

Liquid chlorine bleach dispenser

continued on next page

4. Turn the Water Level Selector to the setting that corresponds with the size of your wash load and the type of fabric being washed.

- To change the load size setting after the washer has started to fill, turn the Selector to the desired new setting.

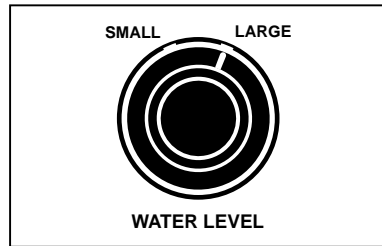

5. Select a wash-rinse temperature with the Temperature Selector. Match the water temperature with the type of fabric and soils being washed.

- See page 14 for water temperature guidelines.
- The top temperature is the wash water and the bottom temperature is the rinse water.

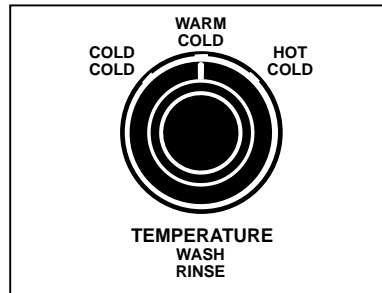

6. Push in the Cycle Control Knob and turn it clockwise to the wash cycle you want. See page 7.

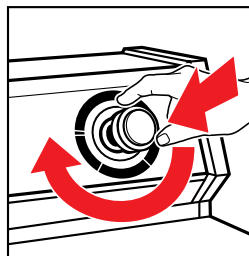

7. Pull out the Cycle Control Knob to start the washer.

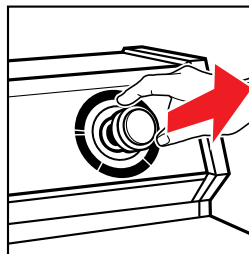

8. (OPTIONAL STEP) If desired, add measured and diluted liquid fabric softener to the final rinse cycle. See page 10.

## Stopping/restarting your washer

- To **stop** your washer at any time, push **in** the Cycle Control Knob.
- To **restart** the washer, close the lid (if open) and pull out the Cycle Control Knob.

## Selecting a cycle and time

This section illustrates and describes the wash cycles you can select with the Cycle Control Knob. Use this information to help you make the best cycle selections for your wash load. Each cycle is designed for different types of fabrics and soil levels.

- The washer pauses briefly throughout each cycle. These pauses are normal for washer operation.

- Refer to page 9 to learn more about the sounds you may hear during a wash cycle.
- Also, refer to page 9 to help you understand what happens during a wash cycle.

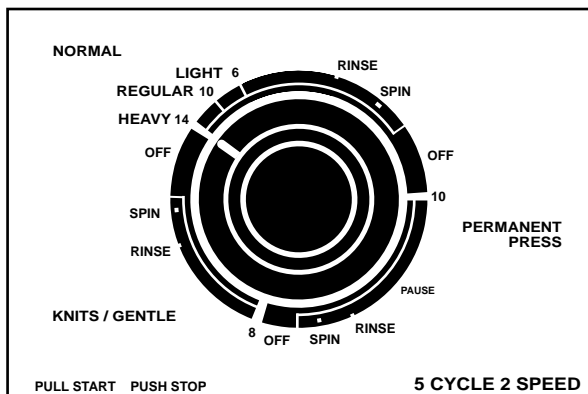

### Normal cycle

The Normal cycle features high agitation and spin speeds to shorten drying time. Use this cycle for cleaning cotton and linen fabrics. Select 6, 10, or 14 minutes of wash time, depending on whether your wash load is lightly, moderately, or heavily soiled.

### Permanent Press cycle

The Permanent Press cycle features a cool-down rinse, and low spin speeds to reduce wrinkling. Use this cycle for cleaning permanent press and some synthetic fabrics.

### Knits/Gentle cycle

The Knits/Gentle cycle features a brief soak and reduced agitation speed for gentle soil removal. Low spin speeds reduce wrinkling. Use this cycle for cleaning delicate items and washable knits.

## Using rinse and spin

When using extra detergent for heavily soiled clothes, or washing special-care items, you may find an extra rinse and spin is needed.

1. For an additional rinse, push in the Cycle Control Knob and turn it clockwise to RINSE.
2. Pull out the Cycle Control Knob. The washer fills, agitates, drains, and spins.

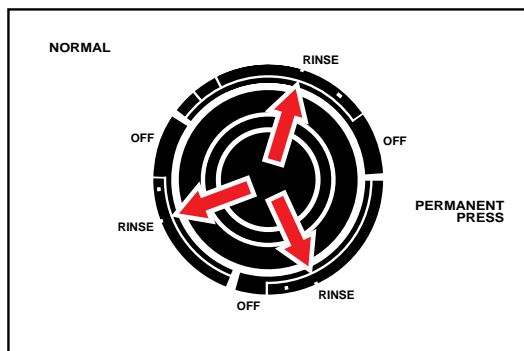

## Using drain and spin

A drain and spin may help shorten drying time for some heavy fabrics or special-care items by removing excess water.

1. Push in the Cycle Control Knob and turn it clockwise to SPIN.
2. Pull out the Cycle Control Knob. The washer drains, then spins.

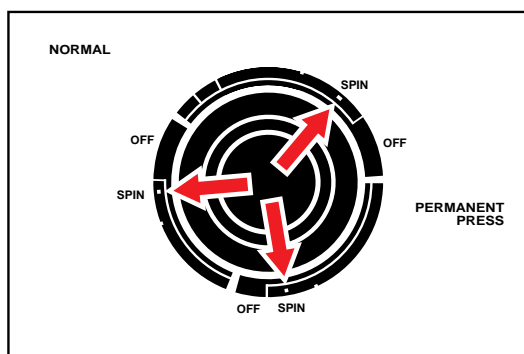

## Self-cleaning lint filter

The lint filter at the bottom of the washer basket cleans itself. During agitation, wash and rinse water passes over the filter, separating the lint from the water. The lint is then spun away from the filter and out of the system during the spin part of the cycle.

If your washer drains into a tub, remove any lint collected in the tub or strainer.

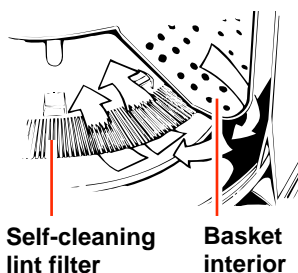

## Understanding what happens in each cycle

When the Cycle Control Knob is set to a number and pulled out, the washer fills before agitation and timing start. The washer begins agitating immediately after filling; agitation occurs with the washer lid up or down.

After agitation starts, the Cycle Control Knob turns clockwise until it points to an OFF area and the cycle ends.

**NOTE:**

- The washer pauses briefly throughout each cycle. These pauses are normal for washer operation.

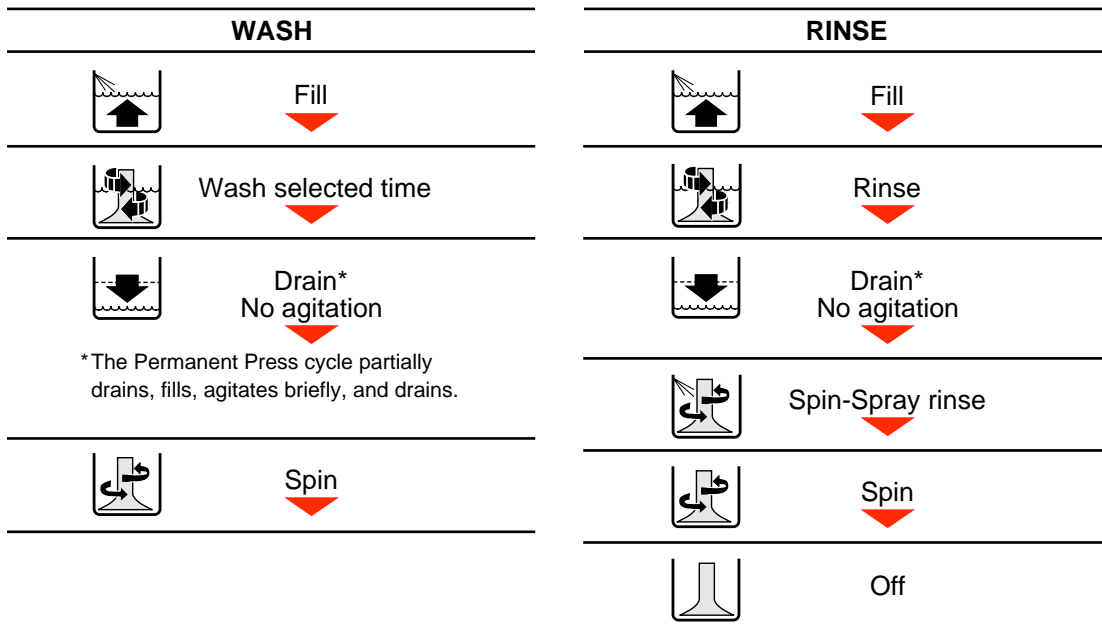

## Understanding normal washer sounds

Your new washer may make sounds that your old one didn't. Because the sounds are unfamiliar, you may be concerned about them. Don't be; most of them are normal.

The following describes some of the sounds you may hear and what causes them.

### During washing

When you select a small load size setting for a small wash load, the water level in your washer is lower. With this lower water level, you may hear a clicking sound from the upper portion of the agitator.

### During drain

The rate that water is drained from your washer depends on your installation. If water is drained quickly from the washer, you may hear air being pulled through the pump. This happens during the end of draining.

### After drain and before spin

When the cycle changes from draining to spinning, you may hear gears engaging.

---

### Adding liquid chlorine bleach

Always measure liquid chlorine bleach. Do not guess. Never use more than 1 cup (250 mL) for a full load. Use less with lower water level settings. Follow manufacturer's directions for safe use. Use a cup with a pouring spout to avoid spilling.

1. Load the washer.
2. Pour measured chlorine bleach carefully into the dispenser. Do not let bleach splash, drip, or run down into washer basket. Undiluted bleach will damage any fabric it touches.
3. Start the washer. Bleach will be diluted and dispensed automatically during wash part of cycle.

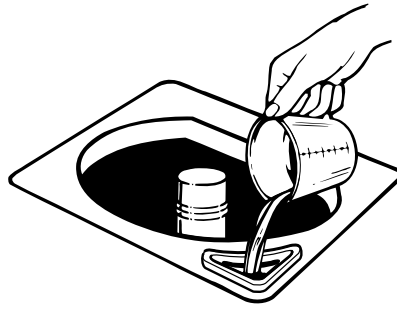

**NOTE:** Do not use this dispenser to add powdered chlorine or color safe bleach to your wash load. The dispenser is for liquid chlorine bleach use only.

---

### Adding liquid fabric softener

- Always dilute fabric softener with  $\frac{1}{2}$  to 1 cup (125 to 250 mL) warm water. Undiluted fabric softener can stain fabrics.
- Add diluted fabric softener only in the final rinse.
- Fabric softener should not be mixed with other laundry products because greasy stains may form. If stains form, remove by wetting the stain and rubbing with liquid detergent or a bar of soap. Rewash the stained item.
- Too much fabric softener can make some items (diapers and towels) nonabsorbent. If this happens, use less fabric softener or do not use it every time.

# Caring for Your Washer

Proper care of your washer can extend its life. This section explains how to care for your washer properly and safely.

## Cleaning your washer

### Exterior

Wipe up detergent, bleach, and other spills with a soft, damp cloth or sponge as they occur. Occasionally wipe the outside of the washer to keep it looking like new.



Do not put sharp or metal objects in your washer. They can damage the finish. Check all pockets for pins, clips, money, bolts, nuts, etc. Do not lay these objects on your washer after emptying pockets.



### Interior

Clean interior with 1 cup (250 mL) of chlorine bleach mixed with 2 cups (500 mL) of detergent. Run washer through a complete cycle using hot water. Repeat process if necessary.

**NOTE:** Remove hard water deposits using only cleaners labeled as washer safe.

---

## Winter storage or moving care

Install and store your washer where it will not freeze. Because some water may stay in the hoses, freezing can damage your washer. If storing or moving your washer during freezing weather, winterize it.

### To winterize washer:

1. Shut off both water faucets.
2. Disconnect and drain water inlet hoses.
3. Put 1 quart (1L) of R.V.-type antifreeze in the basket.
4. Run washer on a drain and spin setting (see page 8) for about 30 seconds to mix the antifreeze and water.
5. Unplug the power supply cord.

### To use washer again:

1. Flush water pipes and hoses.
2. Reconnect water inlet hoses.
3. Turn on both water faucets.
4. Reconnect power supply cord.
5. Run the washer through a complete cycle with 1 cup (250 mL) of detergent to clean out antifreeze.

---

## Non-use or vacation care

Operate your washer only when you are at home. If you will be on vacation or not using your washer for an extended period of time, you should:

- Unplug the power supply cord or turn off electrical power to the washer.
- Turn off the water supply to the washer. This helps avoid accidental flooding (due to a water pressure surge) while you are away.

# Laundry Tips

This section reviews proper laundering techniques, gives you additional washing information, and discusses solutions to common laundering problems.

## Preparing clothes for washing



- Close zippers, snaps, and hooks to avoid snagging other items. Remove pins, buckles, and other hard objects to avoid scratching the washer interior. Remove non-washable trim and ornaments.
- Empty pockets and turn them inside out.
- Turn down cuffs and brush away lint and dirt.
- Turn synthetic knits inside out to avoid pilling.
- Tie strings and sashes so they will not tangle.
- Mend tears, loose hems, and seams.
- Treat spots and stains. (See “Removing Stains” on pages 16-18.)
- Stained or wet garments should be washed promptly for best results.

---

## Sorting



- Separate heavily soiled items from lightly soiled ones even if they would normally be washed together. Separate lint givers (towels, chenille) from lint takers (corduroy, synthetics, permanent press). When possible, turn lint givers inside out.
- Separate dark from light colors, colorfast items from noncolorfast items.
- Sort by fabric and construction (sturdy cottons, knits, delicate items).

---

## Loading



- Drop items into washer loosely. Fill to the top of the basket, but do not pack or wrap items around the agitator. Items should move easily through wash water for best cleaning and wrinkle-free results. Items should sink and reappear later.
- To reduce wrinkling, permanent press and synthetic knits should have more room to move in the water than heavy items (towels, jeans).
- Overloading or packing can:
  - cause poor cleaning.
  - increase wrinkling.
  - create excessive lint.
  - wear out items faster (because of pilling).
- Load by the amount of space items take up, not by their weight.
- Mix large and small items in each load.



Load evenly to maintain washer balance. An off-balance load can make the machine vibrate during spin.

**Loading suggestions**

For these suggested full-sized loads, set the Water Level Selector to the highest water level setting.

<b>EXTRA LARGE CAPACITY WASHERS</b>			
<p><b>Heavy Work Clothes</b>                      2 pair pants                      3 shirts                      3 pair jeans                      1 coverall</p>	<p><b>Permanent Press</b>                      1 double sheet                      1 tablecloth                      1 dress                      1 blouse                      2 slacks                      3 shirts                      2 pillowcases</p>	<p><b>Mixed Load</b>                      2 double or                      1 king size                      sheet(s)                      4 pillowcases                      6 T-shirts                      6 pair shorts                      2 shirts                      2 blouses                      6 handkerchiefs</p>	<p><b>Towels</b>                      8 bath towels                      8 hand towels                      10 wash cloths                      1 bath mat</p>
<p><b>Knits</b>                      2 slacks                      2 blouses                      4 shirts                      4 tops                      2 dresses</p>			<p><b>Delicates</b>                      2 camisoles                      4 slips                      4 panties                      2 bras                      2 nighties</p>

**Saving energy**

- Use warm or cold wash water for most loads. Use hot water only when washing heavy, greasy soils or whites.
- Use cold rinses.
- Wash full loads.
- Use lower water levels when washing small loads.
- Avoid rewashing. Use enough detergent and pretreat stains or heavy soils. Use the cycles and wash times recommended for the fabric and soil.
- Use your washer during off-peak hours – usually early morning and late evening. (Ask your power company.)

## Water guidelines

### Selecting water temperatures

WASH WATER TEMPERATURE*	SUGGESTED FABRICS	COMMENTS
<b>HOT</b> 130°F (54°C) or above	<ul style="list-style-type: none"> <li>• Work clothes</li> <li>• Sturdy whites/colorfast pastels</li> <li>• Diapers</li> </ul>	<ul style="list-style-type: none"> <li>• Best cleaning for heavily soiled items</li> <li>• Removes oils, perspiration, greasy soils, and stains</li> <li>• Prevents graying or yellowing</li> </ul>
<b>WARM</b> 90-110°F (32-44°C)	<ul style="list-style-type: none"> <li>• Dark/noncolorfast colors</li> <li>• Permanent press items</li> <li>• Nylon, polyester, acrylics, silks, woolens</li> <li>• Knits/delicate fabrics</li> </ul>	<ul style="list-style-type: none"> <li>• Best for moderately soiled to lightly soiled items</li> <li>• Safe for most fabric finishes</li> <li>• Less fading and dye bleeding</li> <li>• Reduces wrinkling</li> </ul>
<b>COLD</b> 70-90°F (21-32°C)	<ul style="list-style-type: none"> <li>• Extra-sensitive colors</li> <li>• Noncolorfast items</li> <li>• Hand washables</li> </ul>	<ul style="list-style-type: none"> <li>• Best for very lightly soiled items</li> <li>• Saves hot water</li> <li>• Best rinse water temperature</li> </ul>

\* The washer features cold rinses for all wash temperatures.

### Checking hot water temperature

Your hot water should be 130°F (54°C) or above. If you do not know your hot water temperature, you can check it easily. You may need to raise the temperature of your water heater. To check your hot water:

1. Fill a pan with the hottest water available from the faucet that fills your washer.

**NOTE:** If you do not have a faucet at your washer site, collect the water from the faucet closest to your washer.

2. Place a candy thermometer or cooking thermometer in the water to check the temperature.

**NOTE:** In wash water temperatures colder than 70°F (21°C), detergents do not dissolve well. Also, soils may be difficult to remove, and some fabrics may retain wear wrinkles and may have increased pilling.

### Water hardness

Many poor washing results can be traced to the hardness of the wash water. To check your water hardness:

- City water – ask the city water company.
- Well water – ask the local water authority.

Ask for the mineral content in grains/gallon or parts/million. If your water is more than 8 grains/gallon or more than 137 parts/million, you should consider:

- Installing a water softener.
- Using more detergent.
- Using a packaged water conditioner.
- Not using soap.

## Washing special-care items

Most garments and household textiles have care labels with laundering instructions. **Always follow care label directions when they are available.** Below are general washing instructions for some special washables.

ITEM	CARE INSTRUCTIONS
<b>Blankets</b> (electric or woolen)	Pretreat spots and stains. Select wash cycle according to the type of blanket being washed. An extra rinse may be necessary (see page 8 for rinse and spin information). Check care label to see if manufacturer recommends machine washing.
<b>Curtains, drapes, slipcovers</b>	Wash small loads. Crowding may cause wrinkling. Replace slipcovers while still slightly damp. They will dry to fit tightly.  <b>NOTE:</b> Sun-damaged curtains and draperies will tear whether hand or machine washed.
<b>Diapers</b>	When using chlorine bleach for soaking, add extra detergent to the load. Avoid overuse of fabric softeners – absorbency will be reduced.
<b>Elastic, spandex</b>	Elastic picks up oil from the body. Oil can damage elastic. Wash often to reduce the damage. Use warm water and sufficient detergent to remove oils. Do not use chlorine bleach.
<b>Flame-retardant clothing</b>	Items will be clearly labeled as flame-retardant. Follow manufacturer's instructions to retain flame-retardant qualities.
<b>Knits, washable</b>	Knits are comfortable to wear because they stretch. However, this means that knits are more likely to be stretched and damaged when washed (especially bulky knits). Knits made of synthetic fabrics such as polyester, nylon, and acrylic tend to keep their original shape more than a knit made of cotton or ramie.
<b>Pillows, stuffed toys</b>	Washing feather pillows is not recommended unless they will be dried in a dryer.
<b>Plastic, rubber items</b>	Treat as delicate items. Wash in warm water. Wash small items in a mesh bag.
<b>Quilts, bedspreads</b>	Do not wash cotton-filled comforters unless they are quilted or stitched. Tucked cotton batting tends to slip and become lumpy. An extra rinse may be necessary.
<b>Scatter rugs</b>	Shake or vacuum rugs to remove loose dirt. Wash more than one rug at a time. If washing only one rug, add bath towels to balance the load.
<b>Snowsuits, jackets</b>	Wash only one or two items at a time. You may need to stop the washer occasionally to press air from the items being washed. An extra rinse may be necessary.

# Removing Stains

Stained, heavily soiled, or greasy items may need to be prewashed or soaked for best results. Soaking helps remove protein-type stains like blood, milk, or grass. Prewashing helps loosen soil before washing.

## Stain removal rules

- Use warm water for soaking or prewashing stained laundry. Hot water can set stains.
- Most stains are easier to remove when they are fresh. Old or set stains may not come out. Follow package directions for pretreatment products.
- Before treating any stain, find out what kind of stain it is, how old the stain is, what kind of fabric it is, and if the fabric is colorfast. (Check the care label.)
- Washing and drying can set some stains.
- Start with cold or warm water. Hot water can set some stains.
- When bleach is recommended, use a bleach that is safe for the fabric.
- Test stain removers on an inside seam or hidden corner of the item to see if the color is removed.
- Put the stained area face down on a paper towel or white cloth. Apply the stain remover to the back of the stain. This forces the stain off the fabric instead of through it.
- Meat tenderizer or enzyme presoaks help break down some protein stains so they are easier to remove.

## Stain removal guide

STAIN	TO REMOVE
<b>Alcoholic beverage</b>	These stains turn brown with age, so treat immediately. Sponge or soak fresh stains with cold water. Wash. If stain remains, soak 15 minutes in a solution of lukewarm water, liquid detergent, and a few drops of white vinegar. Rinse. Wash.
<b>Blood</b>	Rinse immediately or soak in cold water with enzyme presoak for 30 minutes or longer. Rinse. Rub detergent into any remaining stains. Rinse. If stain remains, put a few drops of 3% hydrogen peroxide on stain for 3-5 minutes. Rinse thoroughly. Wash.
<b>Chewing gum</b>	Use ice to make gum hard. Scrape off what you can. Sponge with a nonflammable fabric cleaner. Let dry. Wash.
<b>Chocolate or coffee</b>	Sponge immediately with a nonflammable fabric cleaner or apply a prewash soil and stain remover. Rinse. Wash. If stain remains, apply a liquid detergent to stain or soak in warm water with an enzyme presoak. Rewash.
<b>Crayon and candle wax</b>	Scrape off excess with a dull knife. Place fabric between two blotters or facial tissue. Press with warm iron. Remove color stain with nonflammable fabric cleaner. Hand wash until stain is gone. If full load is crayon stained, take to cleaners or coin-operated dry cleaning machine.
<b>Cream, milk, or ice cream</b>	Sponge with a nonflammable fabric cleaner or a prewash soil and stain remover. Rinse. Wash. Repeat if necessary. If stain remains, apply a few drops of liquid detergent and a few drops of ammonia. Blot dry and rinse. If stain remains, soak in an enzyme presoak. Wash.

STAIN	TO REMOVE
<b>Deodorants and anti-perspirants</b>	<b>Light stain:</b> Treat with liquid detergent or your regular laundry detergent. Wash in hottest water safe for fabric.
	<b>Heavy stain:</b> Place face down on towel and treat with a paste of ammonia and color safe bleach. Let stand for 30 minutes. Wash in hottest water safe for fabric.



## ! WARNING

**Fire Hazard**

**Do not wash or dry items soiled with vegetable or cooking oils because they may contain some oil after laundering.**

**Doing so can result in death or fire.**

<b>Fat, grease, or oil</b>	<p>Items soiled with vegetable or cooking oil should not be washed or dried. For other types of greasy stains, use one of the methods below:</p> <ul style="list-style-type: none"> <li>• Use pretreatment stain remover. Follow label directions. Wash in hottest water safe for fabric.</li> <li>• Use talcum powder to absorb as much grease as possible. Sponge with a nonflammable fabric cleaner. Rinse. Wash.</li> <li>• Treat with liquid detergent or rub a detergent paste on the stain. Wash using hottest water safe for fabric.</li> </ul>
<b>Fruit stains</b>	<p><b>Fresh stains:</b> Soak immediately in cool water. Wash. If stain remains, cover area with a paste made of color safe bleach, a few drops of hot water, and a few drops of ammonia. Wait 15 to 30 minutes. Wash.</p> <p><b>Old stains:</b> Sponge with white vinegar. Rinse. Repeat procedure for fresh stains.</p>
<b>Grass or green vegetables</b>	<p>Soak in warm or cold water with an enzyme presoak for at least 30 minutes, or sponge with denatured alcohol. Wash in water temperature and bleach safe for the fabric. For colored fabrics, check colorfastness before applying alcohol. For acetate, sponge with a nonflammable fabric cleaner. If stain remains, bleach with 3% hydrogen peroxide. Rinse. Rewash.</p>
<b>Ink or ballpoint pen ink</b>	<p>Spray stain with an aerosol hair spray or rubbing alcohol. Sponge stain continuously until all bleeding stops. Let dry. Repeat if necessary. Wash. If stain remains, bleach if safe for fabric. (India and other indelible inks are almost impossible to remove completely.)</p>
<b>Iron or rust</b>	<p><b>Colored or noncolorfast items:</b> Apply lemon juice and salt. Place in the sun to dry. Rinse thoroughly. Repeat if necessary.</p> <p><b>White or colorfast items:</b> Try a rust remover. Test first on inside seam or hem. Some rust removers are not washer safe. Follow package directions.</p>

continued on next page

## REMOVING STAINS

STAIN	TO REMOVE
<b>Ketchup or tomato products</b>	Sponge immediately with a nonflammable fabric cleaner or apply a prewash soil and stain remover. Rinse. Wash. If stain remains, apply a liquid detergent to stain or soak in warm water with an enzyme presoak. Rewash.
<b>Lipstick</b>	Apply nonflammable fabric cleaner or prewash soil and stain remover. Blot with absorbent material. Repeat if necessary. Rinse. If stain still remains, rub with liquid detergent. Wash.
<b>Meat juice, egg</b>	Scrape off excess with a dull knife. Soak in cold or warm water with enzyme presoak at least 30 minutes, or treat stains with a nonflammable fabric cleaner. Wash.
<b>Mildew</b>	Wash in hottest water safe for fabric. If stain remains, soak in warm water and a color safe bleach for 15 to 30 minutes. Rewash. (Old mildew stains are almost impossible to remove. Mildew fungus destroys or weakens fabrics.) An alternative to bleach is to treat with salt and lemon juice and dry in direct sunlight. Rinse and rewash. Mildew may form if wet or damp laundry remains in your washer for extended periods of time. To prevent mildew, promptly dry laundry after washing.
<b>Mustard</b>	Treat immediately. Scrape off excess mustard. Sponge with a nonflammable fabric cleaner or a prewash soil and stain remover. Rinse. Work liquid detergent and a few drops of vinegar into stain. Rinse. If stain remains, apply 3% hydrogen peroxide. Rinse and wash.
<b>Paint</b>	Hand wash paint-stained items. <b>Water base:</b> Treat stains while still wet. (These paints cannot be removed after they have dried.) Rinse in warm water to flush out paint. Sponge with a nonflammable fabric cleaner. Rinse. Wash. <b>Oil base:</b> Scrape off fresh paint. Sponge with a nonflammable fabric cleaner. While stain is still wet with solvent, rub liquid detergent into it. Wash with hottest water safe for fabric.
<b>Perspiration</b>	Remove stains before ironing. Perspiration stains may weaken fabric. Wash or sponge stain thoroughly with detergent and warm water. If perspiration has changed the color of the fabric, use one of the following treatments: <b>Fresh stains:</b> Apply ammonia to stain. Rinse. Launder to remove ammonia odor. <b>Old stains:</b> Apply white vinegar to stain. Rinse. Launder to remove vinegar odor.
<b>Scorch</b>	Severe scorch cannot be removed. Wet stain with 3% hydrogen peroxide. Cover with a dry cloth and press with an iron as hot as is safe for fabric. Rinse well. Wash. <b>OR</b> Wet with lemon juice and spread in the sun to dry. Wash.
<b>Soft drinks</b>	Sponge immediately with cold water and alcohol. Heat and detergent may set stain.

# Troubleshooting

Most laundering problems are easily solved if you understand the cause. Check the following list for common **laundry** problems and the next page for common **washer** problems. If you need further assistance, see page 21.

## Common laundry problems

PROBLEM	CAUSE
<b>Brown, yellow stains</b>	<ul style="list-style-type: none"><li>• Chlorine staining</li><li>• Iron in water heater or pipes; iron and manganese in water</li></ul>
<b>Dye transfer</b>	<ul style="list-style-type: none"><li>• Improper sorting</li><li>• Load not immediately removed from washer after end of cycle</li></ul>
<b>Gray whites, dingy colors</b>	<ul style="list-style-type: none"><li>• Improper sorting</li><li>• Water temperature too low</li><li>• Not enough detergent</li><li>• Using soap in very hard water (use detergent in hard water)</li></ul>
<b>Greasy looking spots</b>	<ul style="list-style-type: none"><li>• Fabric softener poured directly on clothes</li><li>• Not enough detergent</li></ul>
<b>Lint</b>	<ul style="list-style-type: none"><li>• Improper sorting</li><li>• Paper or tissue in pockets</li><li>• Pilling being mistaken for lint</li><li>• Not enough detergent</li></ul>
<b>Load too wet after spin</b>	<ul style="list-style-type: none"><li>• Cycle stopped before spinning is complete</li></ul>
<b>Shrinking</b>	<ul style="list-style-type: none"><li>• Fabric type (some knits stretch during manufacturing – laundering returns fabric to original size)</li><li>• Care label directions not followed</li></ul>
<b>Snags, rips, and holes</b>	<ul style="list-style-type: none"><li>• Items damaged before washing</li><li>• Misuse of chlorine bleach (do not pour directly on clothes)</li><li>• Sharp items not removed from pockets; fasteners not fastened</li></ul>
<b>Stiff, rough fabrics</b>	<ul style="list-style-type: none"><li>• Using soap in very hard water (use detergent in hard water)</li><li>• Not enough detergent</li><li>• Line drying</li></ul>
<b>Twisting/ Tangling</b>	<ul style="list-style-type: none"><li>• Overloading</li><li>• Clothes wrapped around agitator</li></ul>
<b>Wrinkling</b>	<ul style="list-style-type: none"><li>• Overloading (leave more room for permanent press and knits)</li><li>• Load not immediately removed from washer after cycle</li><li>• Cycle selection incorrect</li></ul>
<b>Yellow areas</b> (from body oils)	<ul style="list-style-type: none"><li>• Water temperature too low</li><li>• Not enough detergent</li></ul>

## Common washer problems

Before calling for service, check these:

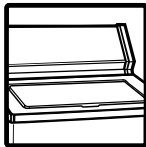

Is the lid closed?



Is the Cycle Control Knob set and pulled out?

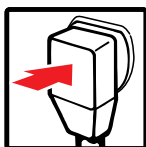

Is the power cord firmly plugged into a live outlet with proper voltage?



Have you blown a household fuse or tripped a circuit breaker?



Are both the hot and cold water faucets turned on?



Are the water hoses kinked or clogged?

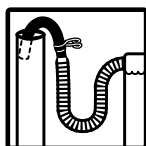

Is the drain hose higher than the water level in the washer? It must be higher for proper operation.



Is the washer making noises (see page 9), or vibrating?

Is the wash load properly distributed around the agitator?

**NOTE:** Washer stops briefly during a wash cycle. These pauses are normal.

If none of these items was causing your problem, see "Requesting Assistance or Service" on page 21.

# Requesting Assistance or Service

Before calling for assistance or service, please check “Troubleshooting” on pages 19-20. It may save you the cost of a service call. If you still need help, follow the instructions below.

## 1. If you need assistance\* ...

Call our toll-free number. Dial toll-free from anywhere in the U.S.A.:



1-800-44-ROPER

1-800-447-6737

and talk with one of our trained consultants. The

consultant can instruct you in how to obtain satisfactory operation from your appliance or, if service is necessary, recommend a qualified service company in your area.

If you prefer, write to:

Roper Brand Home Appliances

Consumer Assistance Center

c/o Correspondence Dept.

2000 North M-63

Benton Harbor, MI 49022-2692

Please include a daytime phone number in your correspondence.

## 2. If you need service\* ...

Contact the dealer from whom you purchased the appliance or the authorized servicer in your area. For help finding an authorized servicer in your area, call our toll-free telephone number in Step 1.



## 3. If you need FSP® replacement parts ...

FSP is a registered trademark of Whirlpool Corporation for quality parts. Look for this symbol of quality whenever you need a replacement part for your ROPER® appliance. FSP replacement parts will fit right and work right, because they are made to the same exacting specifications used to build every new ROPER appliance.

To locate FSP replacement parts in your area, refer to Step 2 or call our toll-free number in Step 1.

## 4. If you are not satisfied with how the problem was solved ...

- Contact the Major Appliance Consumer Action Program (MACAP). MACAP is a group of independent consumer experts that voices consumer views at the highest levels of the major appliance industry.
- Contact MACAP only when the dealer, authorized servicer, and Whirlpool have failed to resolve your problem.

Major Appliance Consumer Action Program  
20 North Wacker Drive  
Chicago, IL 60606

- MACAP will in turn inform us of your action.

### \* When asking for help or service:

Please provide a detailed description of the problem, your appliance's complete model and serial numbers, and the purchase date. (See page 2.) This information will help us respond properly to your request.





# ROPER®

## Automatic Washer Warranty

LENGTH OF WARRANTY	WE WILL PAY FOR
<b>FULL ONE-YEAR WARRANTY</b> FROM DATE OF PURCHASE	Replacement parts and repair labor to correct defects in materials or workmanship. Service must be provided by an authorized Roper service company.
<b>LIMITED 2ND-5TH YEAR WARRANTY</b> FROM DATE OF PURCHASE	Replacement parts for any part of the gearcase assembly if defective in materials or workmanship.
WE WILL NOT PAY FOR	
<p><b>A.</b> Service calls to:</p> <ol style="list-style-type: none"> <li>1. Correct the installation of your washer.</li> <li>2. Instruct you how to use your washer.</li> <li>3. Replace house fuses or correct house wiring or plumbing.</li> </ol> <p><b>B.</b> Repairs when your washer is used in other than normal, single-family household use.</p> <p><b>C.</b> Pickup and delivery. Your washer is designed to be repaired in the home.</p> <p><b>D.</b> Damage to your washer caused by accident, misuse, fire, flood, acts of God, or use of products not approved by us.</p> <p><b>E.</b> Any labor costs during the limited warranty.</p> <p><b>F.</b> Repairs to parts or systems caused by unauthorized modifications made to the appliance.</p>	

3/96

**THIS ROPER APPLIANCE IS WARRANTED BY WHIRLPOOL CORPORATION. UNDER NO CIRCUMSTANCES SHALL IT BE LIABLE UNDER THIS WARRANTY FOR INCIDENTAL OR CONSEQUENTIAL DAMAGES.** Some states do not allow the exclusion or limitation of incidental or consequential damages, so this exclusion or limitation may not apply to you.

This warranty gives you specific legal rights, and you may also have other rights which vary from state to state.

**Outside the United States, a different warranty may apply. For details, please contact your authorized Roper dealer.**

If you need service, first see the "Troubleshooting" section of this book. After checking "Troubleshooting," additional help can be found by checking the "Requesting Assistance or Service" section or by calling our toll-free telephone number, **(1-800-44-ROPER) (1-800-447-6737)**, from anywhere in the U.S.A.