

This Owner's Manual is provided and hosted by Appliance Factory Parts.

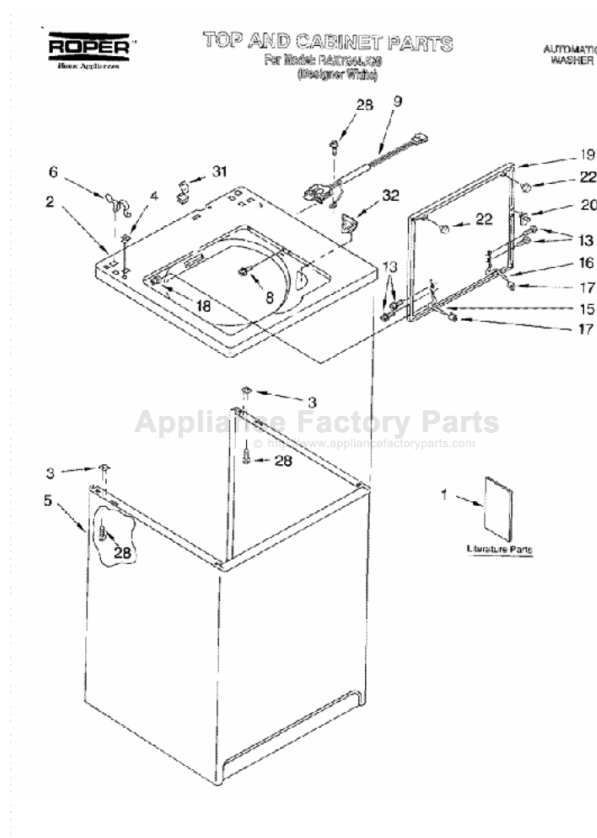

ROPER RAX7244JQ0 Owner's Manual

[Shop genuine replacement parts for ROPER
RAX7244JQ0](#)



[Find Your ROPER Washer Parts - Select From 140 Models](#)

----- Manual continues below -----

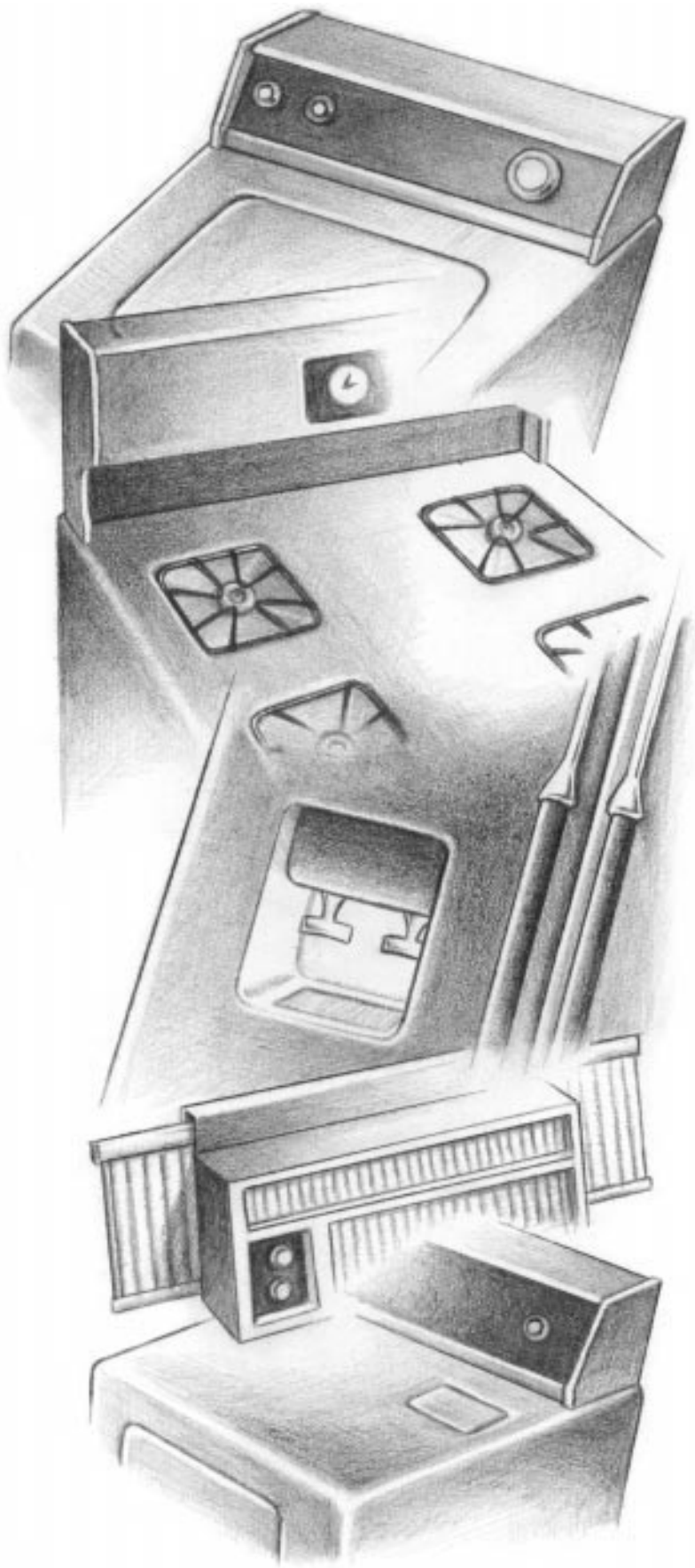

ROPER[®]
BY WHIRLPOOL CORPORATION

ONE AND TWO SPEED AUTOMATIC WASHERS

Use & Care Guide

For questions about features, operation/performance, parts, accessories or service call: **1-800-447-6737**

In Canada, for assistance call: **1-800-461-5681**,
for installation and service call: **1-800-807-6777**

or visit our website at
www.roper.com or
www.roperappliances.com/canada

Table of Contents.....2

TABLE OF CONTENTS

WASHER SAFETY	3
PARTS AND FEATURES	4
WASHER USE	5
Understanding Washer Cycles	5
Loading	5
Normal Washer Sounds	6
Starting Your Washer	6
Selecting a Cycle and Time	8
Rinse and Spin	9
Drain and Spin	9
Adding Liquid Chlorine Bleach	9
Adding Liquid Fabric Softener	9
Self-Cleaning Lint Filter	9
WASHER CARE	10
Cleaning Your Washer	10
Water Inlet Hoses	10
Vacation, Storage and Moving Care	10
TROUBLESHOOTING	11
ASSISTANCE OR SERVICE	13
In the U.S.A.	13
In Canada	13
WARRANTY	16

WASHER SAFETY

Your safety and the safety of others are very important.

We have provided many important safety messages in this manual and on your appliance. Always read and obey all safety messages.



This is the safety alert symbol.

This symbol alerts you to potential hazards that can kill or hurt you and others.

All safety messages will follow the safety alert symbol and either the word "DANGER" or "WARNING." These words mean:

⚠ DANGER

You can be killed or seriously injured if you don't immediately follow instructions.

⚠ WARNING

You can be killed or seriously injured if you don't follow instructions.

All safety messages will tell you what the potential hazard is, tell you how to reduce the chance of injury, and tell you what can happen if the instructions are not followed.

IMPORTANT SAFETY INSTRUCTIONS

WARNING: To reduce the risk of fire, electric shock, or injury to persons when using the washer, follow basic precautions, including the following:

- Read all instructions before using the washer.
- Do not wash articles that have been previously cleaned in, washed in, soaked in, or spotted with gasoline, dry-cleaning solvents, other flammable, or explosive substances as they give off vapors that could ignite or explode.
- Do not add gasoline, dry-cleaning solvents, or other flammable, or explosive substances to the wash water. These substances give off vapors that could ignite or explode.
- Under certain conditions, hydrogen gas may be produced in a hot water system that has not been used for 2 weeks or more. **HYDROGEN GAS IS EXPLOSIVE.** If the hot water system has not been used for such a period, before using the washing machine, turn on all hot water faucets and let the water flow from each for several minutes. This will release any accumulated hydrogen gas. As the gas is flammable, do not smoke or use an open flame during this time.
- Do not allow children to play on or in the washer. Close supervision of children is necessary when the washer is used near children.
- Before the washer is removed from service or discarded, remove the lid.
- Do not reach into the washer if the tub or agitator is moving.
- Do not install or store the washer where it will be exposed to the weather.
- Do not tamper with controls.
- Do not repair or replace any part of the washer or attempt any servicing unless specifically recommended in this Use and Care Guide or in published user-repair instructions that you understand and have the skills to carry out.
- See Installation Instructions for grounding requirements.

SAVE THESE INSTRUCTIONS

PARTS AND FEATURES

This manual covers several different models. The washer you have purchased may have some or all of the parts and features listed below.

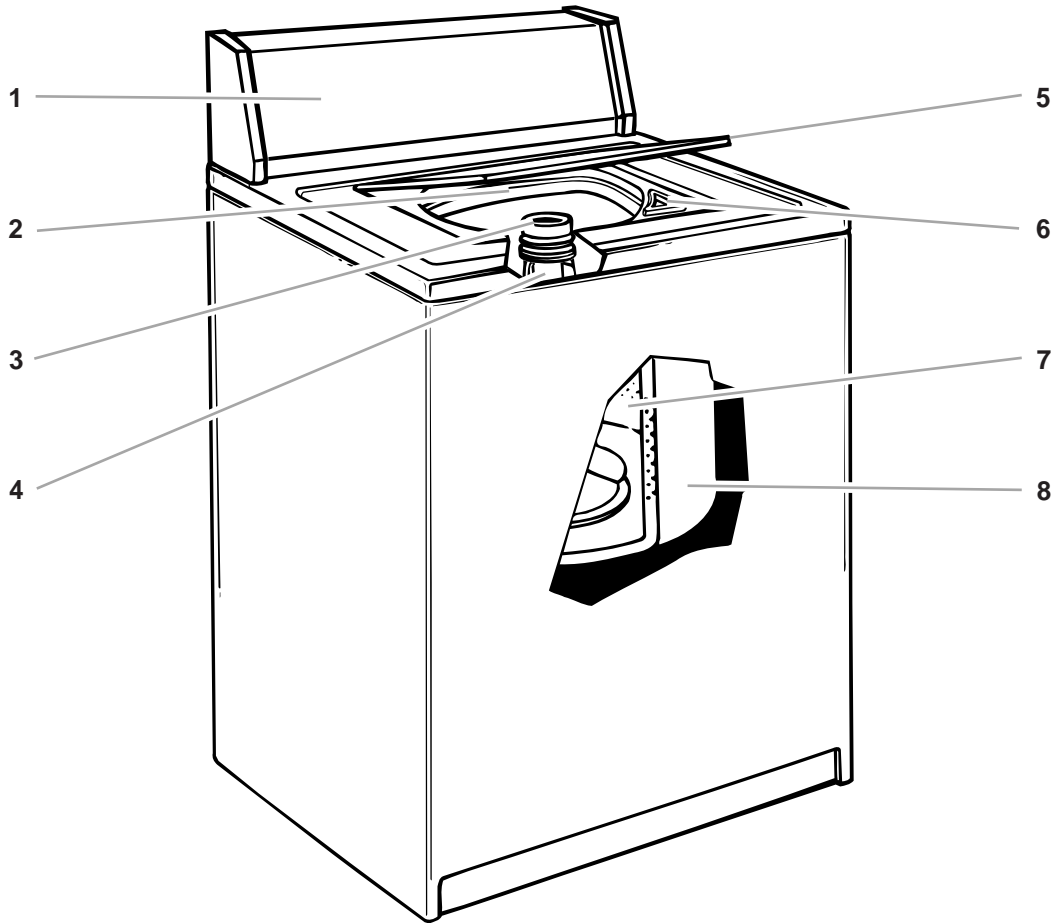

- 1. Control panel
- 2. Model and serial number label
- 3. Liquid fabric softener dispenser[†]
- 4. Agitator
- 5. Lid
- 6. Liquid bleach dispenser[†]

- 7. Basket
- 8. Tub

Other features your washer may have

- Water level selector
- Temperature selector

[†]On some models

Control panel



WASHER USE

Understanding Washer Cycles





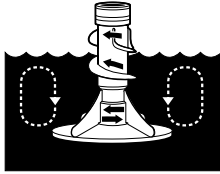





When the Cycle Control knob is set to a number and pulled out, the washer fills (to the selected water level) before agitation and timing start. The washer begins agitating immediately after filling; agitation occurs with the washer lid up or down.

During agitation, the agitator creates a continuous rollover action (on some models) that provides a thorough cleaning of the wash load.



After agitation starts, the Cycle Control knob turns clockwise until it points to an OFF area and the cycle ends.

NOTE: The washer pauses briefly throughout each cycle. These pauses are normal for washer operation.

WASH	RINSE
 1. Fill	 1. Fill
 2. Wash selected time	 2. Rinse
 3. Drain [†] No agitation	 3. Drain No agitation
 4. Spin	 4. Spin-Spray rinse
	 5. Spin
[†] The Permanent Press cycle partially drains, fills, agitates briefly, and drains.	 6. Off

Loading

Loading suggestions

For these suggested full-sized loads, set the WATER LEVEL selector to the highest setting.

SUPER CAPACITY WASHERS

Heavy Work Clothes

3 pair pants	1 coverall
3 shirts	1 overall
4 pair jeans	

Delicates

3 camisoles	2 bras
1 quilted robe	2 nighties
4 slips	1 baby's dress
4 panties	

Towels

10 bath towels	14 wash cloths
10 hand towels	1 bath mat

Mixed Load

3 double sheets	2 shirts
4 pillowcases	2 blouses
8 T-shirts	8 handkerchiefs
6 pair shorts	

EXTRA LARGE CAPACITY WASHERS

Heavy Work Clothes

2 pair pants	3 pair jeans
3 shirts	1 coverall

Delicates

3 camisoles	2 bras
4 slips	2 nighties
4 panties	

Towels

8 bath towels	10 wash cloths
8 hand towels	1 bath mat

Mixed Load

2 double sheets or 1 king size sheet	6 pair shorts
4 pillowcases	2 shirts
6 T-shirts	2 blouses
	6 handkerchiefs

Normal Washer Sounds

Your new washer may make sounds your old one didn't. Because the sounds might be unfamiliar, you may be concerned about them. These sounds are normal.

During washing

When you select a small load size setting, your washer has a lower water level. This can cause a clicking sound from the upper part of the agitator.

During drain

If water is drained quickly from your washer (depending on your installation), you may hear air being pulled through the pump during the end of draining.

After drain and before spin

When the cycle changes from draining to spinning, you may hear gears engaging.

Starting Your Washer

⚠ WARNING



Fire Hazard

Never place items in the washer that are dampened with gasoline or other flammable fluids.

No washer can completely remove oil.

Do not dry anything that has ever had any type of oil on it (including cooking oils).

Doing so can result in death, explosion, or fire.

⚠ WARNING



Electrical Shock Hazard

Plug into a grounded 3 prong outlet.

Do not remove ground prong.

Do not use an adapter.

Do not use an extension cord.

Failure to follow these instructions can result in death, fire, or electrical shock.

1. Measure detergent and pour it into the washer. If desired, add powdered or liquid color safe bleach. Add extra detergent for the Extra Wash cycle.



Drop a sorted load of clothes loosely into your washer.

- Load evenly to maintain washer balance. Mix large and small items.
- Items should move easily through the wash water. Overloading can cause poor cleaning.
- To reduce wrinkling of permanent press clothes and some synthetic knits, select a water level setting to provide more space (see step 5).

- (OPTIONAL STEP) Pour measured liquid chlorine bleach into the liquid chlorine bleach dispenser (on some models). Bleach will be dispensed automatically during the wash part of the cycle.

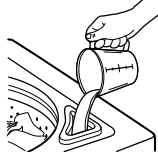

- Never use more than 1 cup (250 mL) for a full load. Use less with a smaller load size.
- Follow the manufacturer's directions for safe use.
- To avoid spilling, use a cup with a pouring spout. Do not let bleach splash, drip, or run down into the washer basket.
- Use only liquid chlorine bleach in this dispenser.

NOTE: On models without a bleach dispenser, see "Adding Liquid Chlorine Bleach."

- (OPTIONAL STEP) Pour measured liquid fabric softener into the liquid fabric softener dispenser (on some models). Softener is added automatically during the rinse portion of the cycle.



Dilute liquid fabric softener by filling the dispenser with warm water until liquid reaches the crossbar in the opening.

- Do not spill or drip any fabric softener on the clothes.
- Use only liquid fabric softener in this dispenser.

NOTE: On models without a fabric softener dispenser, see "Adding Liquid Fabric Softener."

- Close the washer lid.
- Turn the WATER LEVEL selector (on some models) to the correct setting for your wash load and the type of fabric being washed.

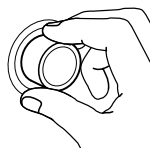

- Choose a load size that allows the load to move freely for best fabric care. See "Loading".
- You may change the load size selection after the washer has started filling by turning the selector to a different setting.

- Set the TEMPERATURE selector (on some models) to the correct setting for the type of fabric and soils being washed. Use the warmest water safe for fabric. Follow garment label instructions

NOTE: On models with temperature selections in the Cycle Control knob, see "Cycle Time and Temperature Options" in the "Selecting a Cycle and Time" section.

Water Temp	Use For
Hot 111°F (44°C) or above	Whites and pastels Heavy and greasy soils
Warm 90°-110°F (32°-43°C)	Bright colors Moderate to light soils
Cold 70°-90°F (21°-32°C)	Colors that bleed or fade Light soils

NOTE: In wash water temperatures colder than 70°F (21°C), detergents do not dissolve well. Soils can be difficult to remove. Some fabrics can retain wear wrinkles and have increased pilling (the formation of small lint-like balls on the surface of garments).

- Push in the Cycle Control knob and turn it clockwise to the wash cycle you want. Reduce the wash time when using a small load size setting. See "Selecting a Cycle and Time."



Pull out the Cycle Control knob to start the washer.

To stop or restart your washer

- To **stop** the washer at any time, push in the Cycle Control knob.
- To **restart** the washer, close the lid (if open) and pull out the Cycle Control knob.

Selecting a Cycle and Time

This section describes the available wash cycles and will help you make the best cycle selections for your wash loads. Each cycle is designed for different types of fabric and soil levels.

- The washer pauses briefly throughout each cycle. These pauses are normal. Refer to “Normal Washer Sounds” to learn more about the sounds you may hear during a wash cycle.
- Refer to “Understanding Washer Cycles” to learn what happens during a wash cycle.

NOTE: This manual covers several different models. The washer you purchased may vary from the model shown and will not have all of the cycles described.

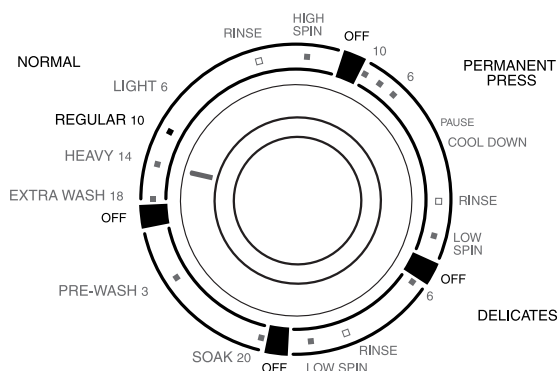

One-speed models

Normal cycle

This cycle features longer spins to shorten drying time. Select up to 14 minutes of wash time, depending on whether your load is heavily, moderately, or lightly soiled.

Extra Wash - Select the 18-minute Extra Wash cycle to wash heavily soiled loads that need maximum soil removal. Use two times the recommended amount of detergent for this cycle.

Permanent Press cycle

This cycle features a cool-down rinse and shorter spins to reduce wrinkling. Select up to 10 minutes of wash time for cleaning permanent press and some synthetic fabrics that are lightly to moderately soiled.

Gentle cycle

This cycle features a brief series of agitations and soaks, followed by a short spin. Select up to 6 minutes of wash time to gently clean special-care items that are lightly to moderately soiled.

Two-speed models

Normal cycle

This cycle features high-speed agitation and longer spin speeds to shorten drying time. Use this cycle for cleaning cotton and linen fabrics. Select up to 14 minutes of wash time, depending on whether your load is heavily, moderately, or lightly soiled.

Extra Wash - Select the 18-minute Extra Wash cycle to wash heavily soiled loads that need maximum soil removal. Use two times the recommended amount of detergent for this cycle.

Permanent Press cycle

This cycle features a cool-down rinse and low spin speeds to help reduce wrinkling. Select up to 10 minutes of wash time for cleaning permanent press and some synthetic fabrics that are lightly to moderately soiled.

Delicates

This cycle features low agitation speed for gentle soil removal. Low spin speeds help reduce wrinkling. Use this 6-minute cycle for cleaning lightly to moderately soiled delicate items and washable knits.

Soak cycle

This cycle features brief periods of agitation and soak time to help remove heavy soils and stains that need pretreatment. Use warm water when soaking laundry. Hot water can set stains. Use the amount of detergent or presoak additive recommended by the manufacturer. After the Soak cycle ends, add detergent and set a new wash cycle.

Pre-Wash cycle

This cycle features a brief period of agitation to help remove heavy soils and stains that need pretreatment. Use the amount of detergent or presoak additive recommended by the manufacturer. After the Pre-Wash cycle ends, add detergent and set a new wash cycle.

Cycle Time and Temperature Options

Some models have the water temperature included in the cycle selections of the Cycle Control knob.

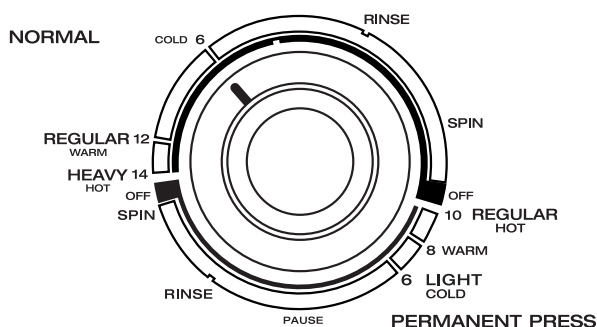

To select different wash time and temperature combinations:

First select the water temperature (HOT, WARM or COLD) then turn to the new wash time. For example, for 14 minutes of wash time in the Normal cycle with Cold water:

1. Push in the Cycle Control knob and turn it clockwise to the Cold setting.
2. Pull out the Cycle Control knob and allow washer to fill.
3. When the washer has filled, push in and turn the Cycle Control knob to 14 minutes of wash time.
4. Pull out the Cycle Control knob to start washer.

Rinse and Spin

When using extra detergent for heavily soiled clothes, or washing special-care items, you may find an extra rinse and spin is needed.

1. Push in the Cycle Control knob and turn it clockwise to any of the Rinse settings.
2. Pull out the Cycle Control knob. The washer fills to the selected load size, agitates, drains, and spins.

Drain and Spin

A drain and spin may help shorten drying times for some heavy fabrics or special-care items by removing excess water.

1. Push in the Cycle Control knob and turn it clockwise to any of the Spin settings.
2. Pull out the Cycle Control knob. The washer drains, then spins.

Adding Liquid Chlorine Bleach

Always measure liquid chlorine bleach. Do not guess. Never use more than 1 cup (250 mL) for a full load. Follow manufacturer's directions for safe use. Use a cup with a pouring spout to avoid spilling.

1. Let the washer fill and begin agitating the load.
2. Add bleach to the wash cycle so it can be removed in the rinse cycle. Pour bleach around the agitator, not directly on the load.
 - Follow directions on the care labels. Do not use chlorine bleach on wool, silk, spandex, acetates, or some flame-retardant fabrics.
 - When soaking with chlorine bleach, add detergent to soak water.

NOTE: Undiluted bleach will damage any fabric it touches. The damage appears as rips, holes, tears, or color loss and may not show up until several washings later.

Adding Liquid Fabric Softener

Always dilute fabric softener with ½ to 1 cup (125 to 250 mL) warm water. Undiluted fabric softener can stain fabrics.

- Add diluted fabric softener only in the final rinse.
- Fabric softener should not be mixed with other laundry products. Greasy stains can form. To remove greasy stains, wet the stain and rub with liquid detergent or a bar of soap. Rewash.
- Too much fabric softener can make some items (diapers and towels) nonabsorbent. If this happens, use less fabric softener, or do not use it every time.

Self-Cleaning Lint Filter

Your washer has a self-cleaning lint filter at the bottom of the basket. Wash and rinse water flow over the filter during agitation, separating the lint from the water. The lint spins out of the system during the spin part of the cycle.

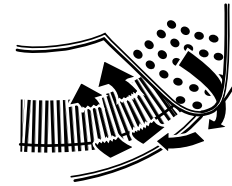

If your washer drains into a tub, remove any lint collected in the tub or strainer.

WASHER CARE

Cleaning Your Washer

Cleaning the exterior

Use a soft, damp cloth or sponge to wipe up any spills such as detergent or bleach. Occasionally wipe the outside of your washer to keep it looking new.

Cleaning the interior

Clean your washer interior by mixing 1 cup (250 mL) of chlorine bleach and 2 cups (500 mL) of detergent. Pour this into your washer and run it through a complete cycle using hot water. Repeat this process if necessary.

NOTE: Remove any hard water deposits using only cleaners labeled as washer safe.

Cleaning the liquid fabric softener dispenser

Flush dispenser periodically with warm water, as shown. Remove the dispenser by grasping the top of the dispenser with both hands and squeezing and pushing upwards with thumbs. Clean the dispenser by rinsing it under a water faucet. Replace it after cleaning.

NOTE: Do not wash clothes with this dispenser removed. Do not add detergent or bleach to this dispenser; it is for liquid fabric softener use only.

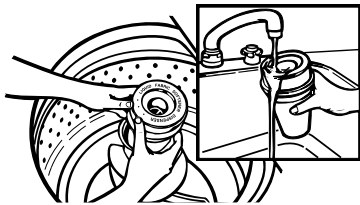

Water Inlet Hoses

Replace inlet hoses after five years of use to reduce the risk of hose failure. Periodically inspect and replace inlet hoses if bulges, kinks, cuts, wear or leaks are found.

When replacing your inlet hoses, mark the date of replacement on the label with a permanent marker.

Vacation, Storage and Moving Care

Install and store your washer where it will not freeze. Because some water may stay in the hoses, freezing can damage your washer. If storing or moving your washer during freezing weather, winterize it.

Non-use or vacation care

Operate your washer only when you are at home. If you will be on vacation or not using your washer for an extended period of time, you should:

- Unplug washer or disconnect power.
- Turn off the water supply to the washer. This helps avoid accidental flooding (due to a water pressure surge) while you are away.

To winterize washer

1. Shut off both water faucets.
2. Disconnect and drain water inlet hoses.
3. Put 1 quart (1 L) of R.V.-type antifreeze in the basket.
4. Run washer on a drain and spin setting (see "Drain and Spin") for about 30 seconds to mix the antifreeze and water.
5. Unplug washer or disconnect power.

To use washer again

1. Flush water pipes and hoses.
2. Reconnect water inlet hoses.
3. Turn on both water faucets.
4. Plug in washer or reconnect power.
5. Run the washer through a complete cycle with 1 cup (250 mL) of detergent to clean out antifreeze.

TROUBLESHOOTING

First try the solutions suggested here and possibly avoid the cost of a service call...

Washer won't fill, rinse or agitate

- **Check the following:**
 - Is the power cord plugged into a grounded 3 prong outlet?
 - Is the indicator on the Cycle Control knob properly lined up with a cycle? Turn the Cycle Control knob to the right slightly and pull to start.
 - Are the water inlet valve screens clogged?
 - Are both the hot and cold water faucets turned on?
 - Is the water inlet hose kinked?
 - **Does the water level seem too low, or does the washer appear to not fill completely?**

The top of the agitator is much higher than the highest water level. This creates a perception that the washer is not filling completely. This is normal.
-

Washer stops

- **Check the following:**
 - Is the power cord plugged into a grounded 3 prong outlet?
 - Is the indicator on the Cycle Control knob properly lined up with a cycle? Turn the Cycle Control knob to the right slightly and pull to start.
 - Are the water inlet valve screens clogged?
 - Are both the hot and cold water faucets turned on?
 - Is the water inlet hose kinked?
 - **Is there power at the plug?**

Check your electrical source or call an electrician.
 - **Has a fuse blown or is the circuit breaker open?**

If problem continues, call an electrician.
 - **Are you using an extension cord?**

Do not use an extension cord.
 - **Is the washer in a normal pause in the Casual/Permanent Press (or Hand Washables) cycle?**

The washer pauses for about 2 minutes in the Casual/Permanent Press cycle. Allow the cycle to continue.

The Hand Washables cycle (on some models) features periods of agitation and soak.
 - **Is the washer overloaded?**

Wash smaller loads.
-

Washer won't drain or spin

- **Is the drain hose clogged, or the end of the drain hose more than 72 inches (183 cm) above the floor?**

See the Installation Instructions for proper installation of drain hose.
 - **Is the lid open?**

The lid must be closed during operation.
 - **Is there excessive sudsing?**

Always measure detergent. Follow manufacturer's directions. If you have very soft water, you might need to use less detergent.
-

- **Is your voltage low?**

Check your electrical source or call an electrician. Do not use an extension cord.
-

Washer continues to fill or drain, or the cycle seems stuck

- **Is the top of drain hose lower than the water level in washer?**

The top of the hose must be higher than the water level in the washer for proper operation. See the Installation Instructions.
 - **Does the drain hose fit too tightly in the standpipe, or is it taped to the standpipe?**

The drain hose should be loose yet fit securely. Do not seal the drain hose with tape. The hose needs an air gap. See the Installation Instructions.
-

Washer makes noise

- **Is the load balanced and the washer level?**

The wash load should be balanced and not overloaded.

The washer must be level. The front feet should be properly installed and the nuts tightened. Reset the rear leveling legs (if needed). See the Installation Instructions.
 - **Did you completely remove the yellow shipping strap with cotter pins?**

See the Installation Instructions.
 - **Are the gears engaging after the drain and before spin, or is the upper part of agitator clicking during wash?**

These are normal washer noises.
-

Washer leaks

- **Check the following:**

Are the fill hoses tight? Are the fill hose washers properly seated? Is the drain hose clamp properly installed? See the Installation Instructions.
 - **Is the sink or drain clogged?**

Sink and standpipe must be able to handle 17 gallons (64 L) of water per minute.
 - **Is water deflecting off the tub ring or the load?**

Center the tub before starting the washer.

The wash load should be balanced and not overloaded. The fill or spray rinses can deflect off the load.

The washer must be level. The front feet should be properly installed and the nuts tightened. Reset the rear leveling legs (if needed). See the Installation Instructions.
 - **Check household plumbing for leaks.**
-

Washer basket is crooked

- **Was the washer basket pulled forward during loading?**

The wash load should be balanced and not overloaded. Push the basket to the center before starting wash.
 - **Is the load balanced and the washer level?**

The wash load should be balanced and not overloaded.

The washer must be level. The front feet should be properly installed and the nuts tightened. Reset the rear leveling legs (if needed). See the Installation Instructions.
 - **The washer basket moves while washing.**

This is normal.
-

Agitator operation

- **The top of the agitator is loose, or moves in only one direction.**
This is normal.

Dispensers clogged or bleach leaking

- **Did you follow the manufacturer's directions when adding detergent and fabric softener to the dispensers?**
Measure detergent and fabric softener. Carefully pour into the dispensers. Wipe up all spills.

Dilute fabric softener in the fabric softener dispenser.
- **Did you put powdered or color-safe bleach in the liquid chlorine bleach dispenser?**
Add powdered or liquid color-safe bleach directly to the basket. Do not use the chlorine bleach dispenser for color-safe bleach.

Load too wet

- **Did you use the right cycle for the load being washed?**
Select a cycle with a higher spin speed (if available).
- **Did you use a cold rinse?**
Cold rinses leave loads wetter than warm rinses. This is normal.

Residue or lint on load

- **Did you sort properly?**
Sort lint givers (towels, chenille) from lint takers (corduroy, synthetics). Also sort by color.
- **Did you overload the washer?**
The wash load must be balanced and not overloaded. Lint can be trapped in the load if overloaded. Wash smaller loads.
- **Check the following:**
Was paper or tissue left in the pockets?

Did you use enough detergent? Follow manufacturer's directions. Use enough detergent to hold the lint in the water.

Is your water colder than 70°F (21°C)? Wash water colder than 70°F (21°C) may not completely dissolve the detergent.

Stains on load

- **Did you follow the manufacturer's directions when adding detergent and fabric softener?**
Measure detergent and fabric softener. Use enough detergent to remove soil and hold it in suspension.

Dilute fabric softener and add to the rinse portion of a cycle only. Do not drip fabric softener on clothes.
- **Is there above average iron (rust) in water?**
You may need to install an iron filter.
- **Did you properly sort the load?**
Sort dark clothes from whites and lights.
- **Did you unload the washer promptly?**
To avoid dye transfer, unload the washer as soon as it stops.

Load is wrinkled

- **Did you unload the washer promptly?**
Unload the washer as soon as it stops.

- **Did you use the right cycle for the load being washed?**
Use the Casual/Permanent Press cycle or another cycle with low spin speeds (if available) to reduce wrinkling.
- **Did you overload the washer?**
The wash load must be balanced and not overloaded. Loads should move freely during washing.
- **Was the wash water warm enough to relax wrinkles, or are you using warm rinses?**
If safe for the load, use warm or hot wash water. Use cold rinse water.
- **Are the hot and cold water hoses reversed?**
Check to be sure the hot and cold water hoses are connected to the right faucets. See the Installation Instructions.

Load is tangled or twisted

- **Did you overload the washer?**
The wash load must be balanced and not overloaded. Loads should move freely during washing.
- **Did you wrap items around the agitator?**
Drop items loosely into the washer. Do not wrap items around the agitator.

Gray whites, dingy colors

- **Did you properly sort the load?**
Dye transfer can occur when mixing whites and colors in a load. Sort dark clothes from whites and lights.
- **Was the wash temperature too low?**
Use hot or warm washes if safe for the load. Hot water should be at least 111°F (44°C) to clean heavy or greasy soils.
- **Did you use enough detergent, or do you have hard water?**
Use more detergent for washing heavy soils in cold or hard water.
- **Are the hot and cold water hoses reversed?**
Check to be sure the hot and cold water hoses are connected to the right faucets. See the Installation Instructions.

Garment damage

- **Check the following:**
Were sharp items removed from pockets before washing?
Empty pockets, zip zippers, snap or hook fasteners before washing.

Were strings and sashes tied to prevent tangling?

Were items damaged before washing? Mend rips and broken threads in seams before washing.
- **Did you overload the washer?**
The wash load must be balanced and not overloaded. Loads should move freely during washing.
- **Did you properly add chlorine bleach?**
Do not pour chlorine bleach directly on load. Wipe up bleach spills. Undiluted bleach will damage fabrics.
- **Did you follow the manufacturer's care label instructions?**

ASSISTANCE OR SERVICE

Before calling for assistance or service, please check "Troubleshooting." It may save you the cost of a service call. If you still need help, follow the instructions below.

When calling, please know the purchase date and the complete model and serial number of your appliance. This information will help us to better respond to your request.

If you need replacement parts

If you need to order replacement parts, we recommend that you only use FSP® factory specified parts. These parts will fit right and work right because they are made with the same precision used to build every new ROPER® appliance.

To locate FSP replacement parts in your area:

In the U.S.A., call the Customer Interaction Center at **1-800-447-6737**, or your nearest designated service center.

In Canada, call **1-800-807-6777**, or your nearest designated service center.

In the U.S.A.

Call the Roper Customer Interaction Center toll free: **1-800-447-6737**.

Our consultants provide assistance with:

- Features and specifications on our full line of appliances
- Installation information
- Use and maintenance procedures
- Accessory and repair parts sales
- Specialized customer assistance (Spanish speaking, hearing impaired, limited vision, etc.)
- Referrals to local dealers, repair parts distributors, and service companies

Roper designated service technicians are trained to fulfill the product warranty and provide after-warranty service anywhere in the United States.

To locate the Roper designated service company in your area, you can also look in your telephone directory Yellow Pages.

For further assistance

If you need further assistance, you can write with any questions or concerns to:

Roper Brand Home Appliances
Customer Interaction Center
c/o Correspondence Dept.
MD 8020
553 Benson Road
Benton Harbor, MI 49022-2692

Please include a daytime phone number in your correspondence.

In Canada

Call the Inglis Limited Consumer Relations Center toll free: **1-800-461-5681** 8:30 a.m. - 6:00 p.m. (EST).

Our consultants provide assistance with:

- Features and specifications on our full line of appliances
- Referrals to local dealers

For service in Canada

Call **1-800-807-6777**. Inglis designated service technicians are trained to fulfill the product warranty and provide after-warranty service anywhere in Canada.

For further assistance

If you need further assistance, you can write to Inglis Limited with any questions or concerns at:

Consumer Relations Center
Inglis Limited
1901 Minnesota Court
Mississauga, Ontario L5N 3A7

Please include a daytime phone number in your correspondence.

Gearcase assembly covered by your warranty

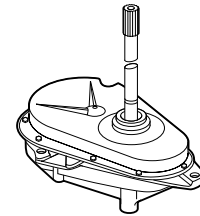

ROPER® WASHER WARRANTY

ONE-YEAR FULL WARRANTY

For one year from the date of purchase, when this washer is operated and maintained according to instructions attached to or furnished with the product, Whirlpool Corporation will pay for FSP® replacement parts and repair labor to correct defects in materials or workmanship. Service must be provided by a Roper designated service company.

SECOND THROUGH FIFTH YEAR LIMITED WARRANTY

For the second through fifth year from the date of purchase, when this washer is operated and maintained according to instructions attached to or furnished with the product, Whirlpool Corporation will pay for FSP® replacement parts for any part of the gearcase assembly, if defective in materials or workmanship.

Whirlpool Corporation will not pay for:

1. Service calls to correct the installation of your washer, to instruct you how to use your washer, or to replace house fuses or correct house wiring or plumbing.
 2. Repairs when your washer is used in other than normal, single-family household use.
 3. Damage resulting from accident, alteration, misuse, abuse, fire, flood, acts of God, improper installation, installation not in accordance with local electrical and plumbing codes, or use of products not approved by Whirlpool Corporation.
 4. Any labor costs during the limited warranty.
 5. Replacement parts or repair labor costs for units operated outside the United States and Canada.
 6. Pickup and delivery. This product is designed to be repaired in the home.
 7. Repairs to parts or systems resulting from unauthorized modifications made to the appliance.
 8. In Canada, travel or transportation expenses for customers who reside in remote areas.
-

THIS ROPER APPLIANCE IS WARRANTED BY WHIRLPOOL CORPORATION AND INGLIS LIMITED. WHIRLPOOL CORPORATION AND INGLIS LIMITED SHALL NOT BE LIABLE FOR INCIDENTAL OR CONSEQUENTIAL DAMAGES.

Some states and provinces do not allow the exclusion or limitation of incidental or consequential damages, so this exclusion or limitation may not apply to you. This warranty gives you specific legal rights and you may also have other rights which vary from state to state or province to province.

Outside the 50 United States and Canada, this warranty does not apply. Contact your authorized Roper dealer to determine if another warranty applies.

If you need service, first see "Troubleshooting." Additional help can be found by checking "Assistance or Service," or call our Customer Interaction Center at **1-800-447-6737** from anywhere in the U.S.A. or write: Roper Brand Home Appliances, Customer Interaction Center, c/o Correspondence Dept., MD 8020, 553 Benson Road, Benton Harbor, MI 49022-2692. In Canada, call Inglis Limited at **1-800-807-6777**.

3/00

Keep this book and your sales slip together for future reference. You must provide proof of purchase or installation date for in-warranty service.

Write down the following information about your washer to better help you obtain assistance or service if you ever need it. You will need to know your complete model number and serial number. You can find this information on the model and serial number label/plate, located on your appliance as shown in "Parts and Features."

Dealer name _____
Address _____
Phone number _____
Model number _____
Serial number _____
Purchase date _____

3953960

© 2000 Whirlpool Corporation.
All rights reserved.

® Registered Trademark of Whirlpool, U.S.A.
Inglis Limited licensee in Canada

03/00
Printed in U.S.A.