

This Owner's Manual is provided and hosted by [Appliance Factory Parts](http://Appliance Factory Parts).

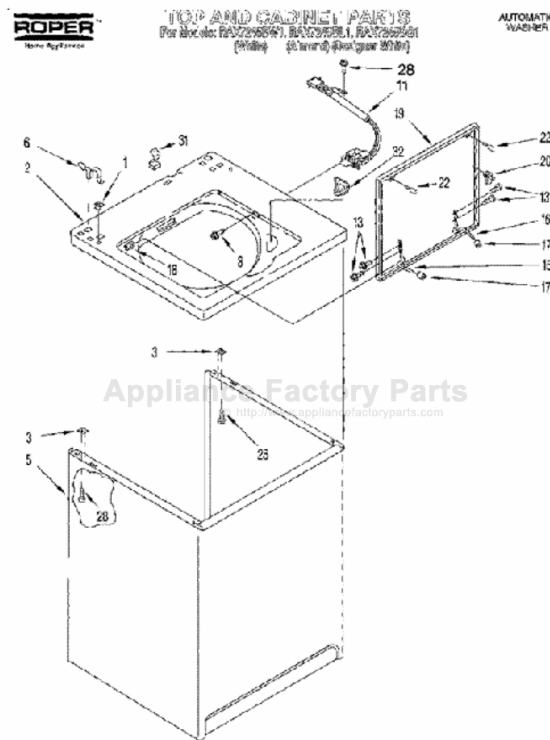

# ROPER RAX7245BQ1 Owner's Manual

[Shop genuine replacement parts for ROPER  
RAX7245BQ1](#)



[Find Your ROPER Washer Parts - Select From 140 Models](#)

----- Manual continues below -----



# Use And Care

## GUIDE

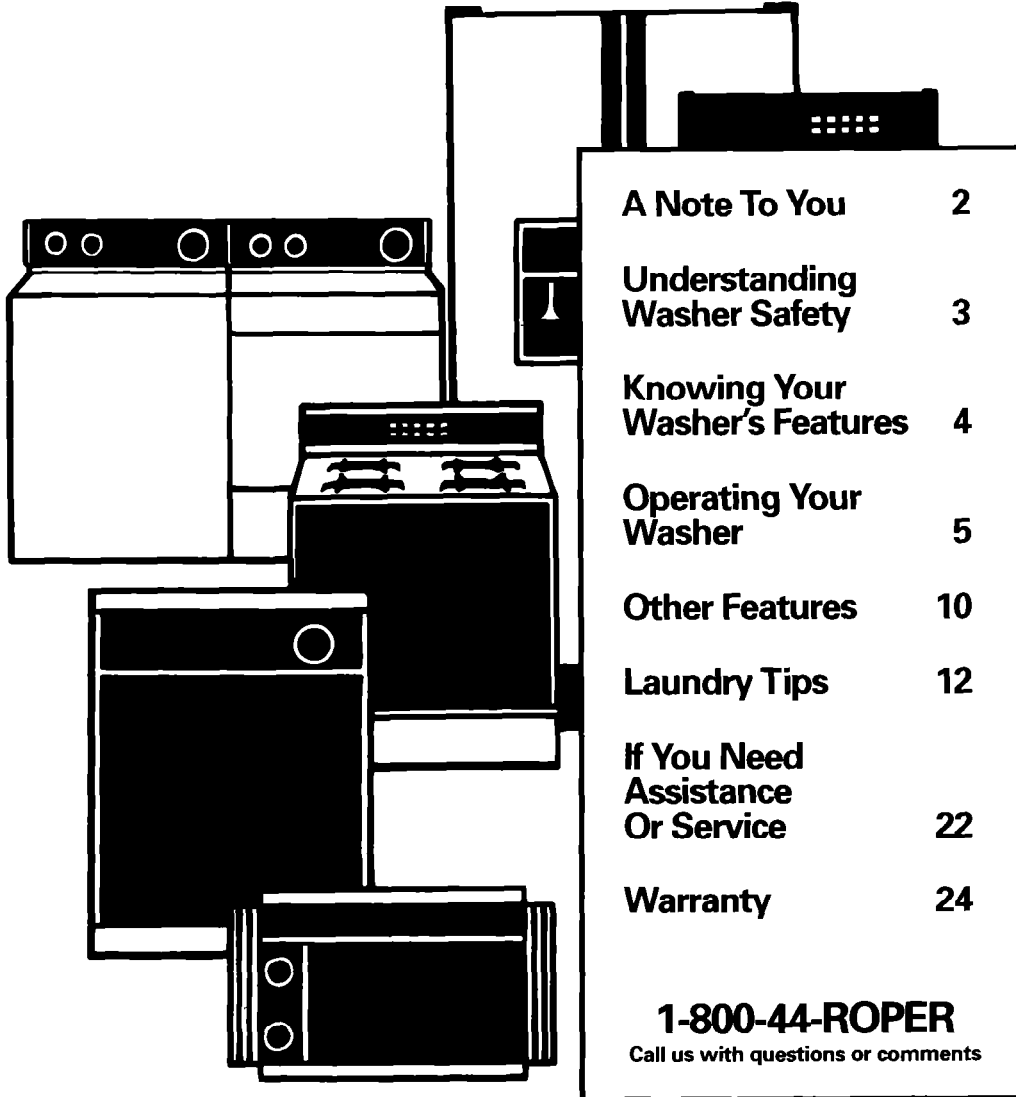

A Note To You	2
Understanding Washer Safety	3
Knowing Your Washer's Features	4
Operating Your Washer	5
Other Features	10
Laundry Tips	12
If You Need Assistance Or Service	22
Warranty	24

**1-800-44-ROPER**  
Call us with questions or comments

**TWO SPEED AUTOMATIC WASHERS**

# A Note To You

## **Thank you for buying a Roper appliance.**

You have purchased a quality, *world-class* home appliance. Years of engineering experience have gone into its manufacturing. To ensure that you will enjoy many years of trouble-free operation, we have developed this Use and Care Guide. It is full of valuable information on how to operate and maintain your appliance properly and safely. Please read it carefully. Also, please complete and mail the Ownership Registration Card provided with your appliance.

## **Your safety is important to us.**

This guide contains safety symbols and statements. Please pay special attention to these symbols and follow any instructions given. Here is a brief explanation of the use of each symbol.

### **⚠ WARNING**

This symbol will help alert you to such dangers as personal injury, burns, fire and electrical shock.

### **⚠ CAUTION**

This symbol will help you avoid actions which could cause product damage (scratches, dents, etc.) and damage to your personal property.

## **Our toll-free number, 1-800-44-ROPER (1-800-447-6737), is available 24 hours a day.**

If you have a question concerning your appliance's operation, or if you need service, first see "If You Need Assistance Or Service" on page 22. If you need further help, call us. When calling, you will need to know your appliance's complete model number and serial number. You can find this information on the model and serial number plate (see diagram on page 4). For your convenience, we have included a handy place below for you to record these numbers, the purchase date from the sales slip and your dealer's name and telephone number. Keep this book and the sales slip together in a safe place for future reference.

Model Number \_\_\_\_\_

Dealer Name \_\_\_\_\_

Serial Number \_\_\_\_\_

Dealer Phone \_\_\_\_\_

Purchase Date \_\_\_\_\_

## IMPORTANT SAFETY INSTRUCTIONS

### **⚠ WARNING**

To reduce the risk of fire, electrical shock or injury to persons when using your washer, follow basic precautions, including the following:

- Read all instructions before using your washer.
  - Do not machine wash or machine dry items cleaned, washed, soaked in, or spotted with wax, paint, gasoline, oil, or other flammable fluids. The fumes can create a fire hazard or explosion. Always hand wash and line dry items containing these materials.
  - Flammable fluids (dry-cleaning solvents, kerosene, gasoline, etc.) should not be used or stored in or near your washer. Do not add flammable fluids to your wash water. These substances give off vapors that can create a fire hazard or explosion.
  - Do not allow children to operate, play with, or crawl on or inside your washer. Supervise children closely when your washer is used near them.
  - Before your washer is removed from service or discarded, remove the lid to prevent accidental entrapment.
  - After starting a cycle, do not reach into the basket unless the Cycle Control Knob is pushed in and all motion stops.
  - Do not tamper with the controls.
  - If your hot water has not been used recently (usually 2 weeks or longer), hydrogen gases may build up in your water heater and your hot water pipes. **HYDROGEN GAS IS EXPLOSIVE.** To prevent injury or damage, before using your washer, turn on all hot water faucets and allow water to run for several minutes. This will allow gases to escape. Do not smoke or use any open flame near your faucet while it is open.
- Please ...
- Have only a qualified person install, repair, or replace parts on washer.
  - Maintain washer properly.
  - Protect washer from the weather and keep it where the temperature will not fall below freezing.
  - Install and level washer on a floor that can support the weight.\*
  - Connect washer to the correct 3-prong outlet, electrical supply, water supply, and drain.\*
  - Ground washer properly.\*
- \*See the Installation Instructions.

### **Understanding your responsibilities**

- Store detergent, laundry aids and other materials in a cool, dry place where children cannot reach them (in a locked cabinet if possible).
- Read and follow instructions on packages of detergent and laundry aids, especially warnings and precautions.
- Do not wash or dry items that are soiled with vegetable or cooking oil. These items may contain some oil after laundering. Due to the remaining oil, the fabric may smoke or catch fire by itself.
- Do not use chlorine bleach and ammonia or acids (such as vinegar or rust remover) in the same wash. Hazardous fumes can form.
- Unplug power supply cord before attempting to service your washer.
- Do not machine wash fiberglass materials. Small particles can stick to the fabrics washed in following loads and cause skin irritation.

– SAVE THESE INSTRUCTIONS –

# Knowing Your Washer's Features

The parts and features of your washer are illustrated below. Become familiar with all parts and features before using your washer.

**NOTE:** The drawings in this book may vary from your washer model. They are designed to show the different features of all models covered by this book. Your model may not include all features.

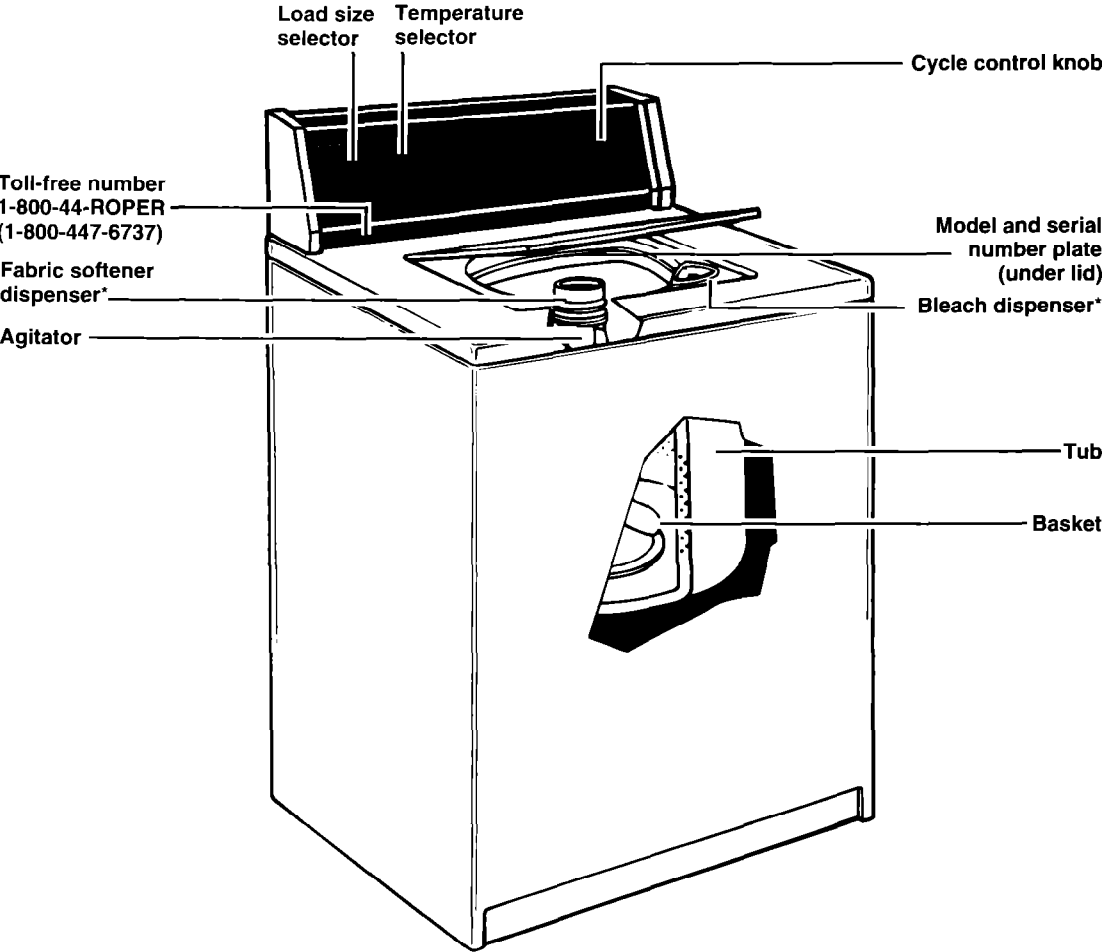

**Other features not shown:**

Self-cleaning lint filter\*

Manual clean lint filter (inside agitator)\*

\*Available on some models

# Operating Your Washer

In This Section		Page	Page
Before starting your washer .....	5	Selecting a cycle and time .....	6
Starting or stopping your washer .....	5	Using rinse and spin .....	8
Selecting a load size .....	5	What happens in each cycle .....	9
Selecting wash-rinse temperatures .....	6		

Operating your washer properly ensures maximum washing efficiency. This section gives you important information to help you to select a cycle, time, and temperature for your wash load.

## Before starting your washer

Add measured detergent. Then place a sorted load in the washer before starting. See page 12 for additional "Before you wash" information.

**NOTE:** Remove any hang tags or temporary labels before using your washer.

## Starting or stopping your washer

### Starting your washer:

1. Select a load size and water temperature.
  2. Push in and turn the Cycle Control Knob clockwise. Stop when the indicator on the knob's outer ring points to the number in the wash cycle you want. The numbers are minutes of wash time.
  3. Pull out the Cycle Control Knob.
- Refer to pages 6-9 for additional information to help you make selections.

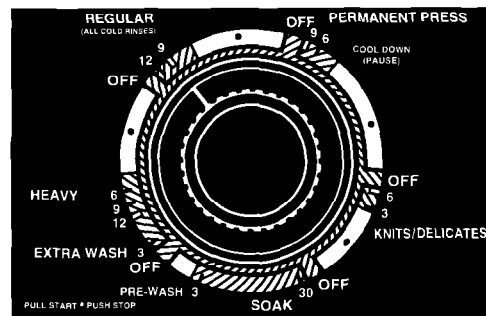

Cycles may vary with model

### Stopping and restarting your washer:

- To stop the washer at any time, push in the Cycle Control Knob.
- To restart the washer, close the lid (if necessary) and pull out the Cycle Control Knob.

## Selecting a load size

Position the Load Size Selector at the setting that corresponds to the size load you want to wash. Select a load size based upon the size of the load and the fabric you are washing. See page 12 for additional loading information.

To change the load size setting after the washer has started to fill, move the selector to the desired new setting.

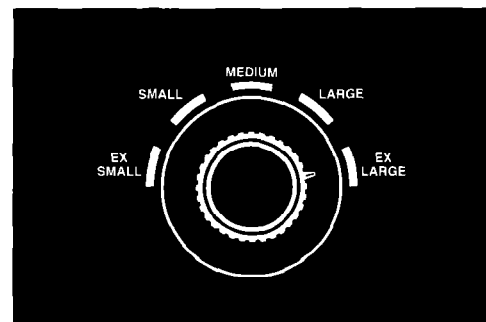

Settings may vary with model

## Load size tips

- Items should move freely in the washer. Do not overload the machine or select a load size that is too small for the wash load.
- Use a large load size setting for best results with permanent press clothes.
- Reduce wash time when using a small load size setting. Loads with only a few items need less wash time.

## Selecting wash-rinse temperatures

Match the water temperature to the type of fabric and soils being washed. The top temperature is the wash water and the bottom temperature is the rinse water.

**NOTE:** The Regular cycle features all cold rinses.

### Water temperature tips

- Use warm wash water with the Permanent Press and Knits/Delicates cycles.
- Always use cold rinse water for permanent press fabrics.
- For heavily soiled permanent press or knit clothes, prewash or presoak before washing in warm water.

See the "Water usage guide" on page 16 for more information.

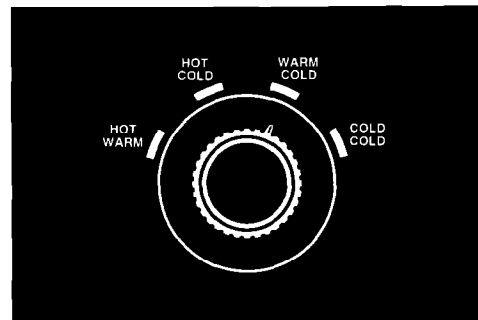

Settings may vary with model

## Selecting a cycle and time

You will find the information you need to help you make correct cycle selections in this section.

- Pages 7-8: Use the information on these pages to guide you when selecting a wash cycle and time.
- Page 9: Use this page to help you understand what happens during a wash cycle.

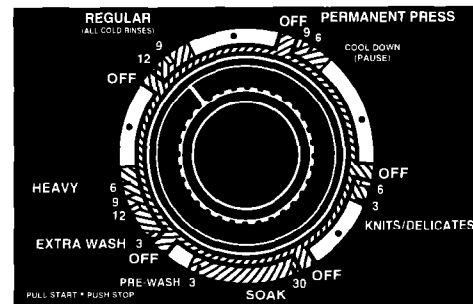

Cycles may vary with model

## Heavy cycle

The Heavy cycle features high agitation and spin speeds.

- Use 9-12 minutes of wash time to clean large loads of sturdily constructed fabrics that are heavily soiled.
- Use 6 minutes of wash time to clean sturdily constructed fabrics that are moderately soiled.

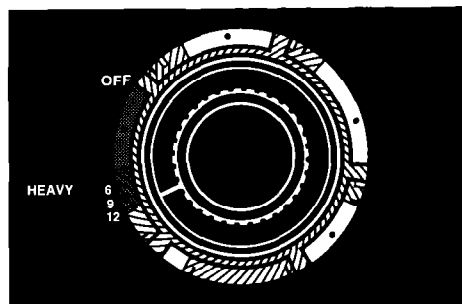

Heavy cycle

## Regular cycle

The Regular cycle features high spin speeds to shorten drying time. All rinses are cold.

- Use 12 minutes of wash time to clean cotton and linen fabrics that are moderately to heavily soiled.
- Use 9 minutes of wash time to clean cotton and linen fabrics that are lightly soiled.

**NOTE:** The Regular cycle features all cold rinses.

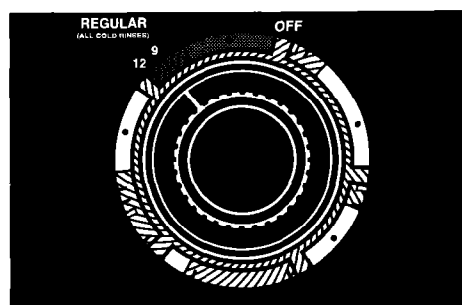

Regular cycle

## Permanent Press cycle

The Permanent Press cycle features a cool-down rinse, and low spin speeds to reduce wrinkling.

- Use 9 minutes of wash time to clean permanent press and some synthetic fabrics that are moderately soiled.
- Use 6 minutes of wash time to clean permanent press and some synthetics that are lightly soiled.

**NOTE:** The washer pauses briefly during the wash cycle. This is normal for washer operation.

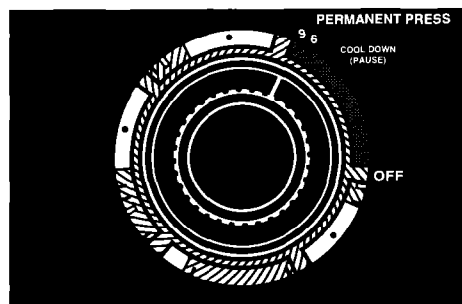

Permanent press cycle

## Knits/Delicates cycle

The Knits/Delicates cycle features a reduced agitation speed for gentle soil removal. Low spin speeds reduce wrinkling.

- Use 6 minutes of wash time, to clean lightly and moderately soiled delicate items and washable knits.

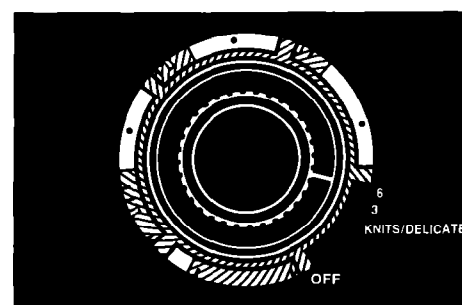

Knits/delicates cycle

## Soak cycle

(on some models)

The Soak cycle features brief periods of agitation and soak time to help remove heavy soils and stains that need pretreatment.

- Use warm water when soaking laundry. (Hot water can set stains.) See pages 13-15 for stain removal information.
- Use the amount of detergent or presoak additive recommended by manufacturer.
- After the Soak cycle ends, add detergent and set a new wash cycle.

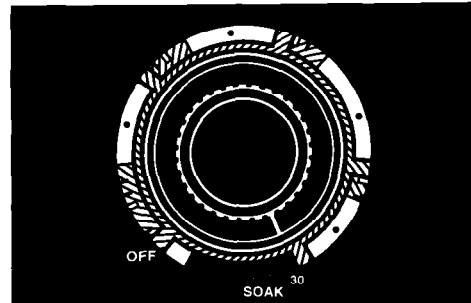

Soak cycle

## Pre-Wash cycle

(on some models)

The Pre-Wash cycle features a brief period of high speed agitation to help remove heavy soils and stains that need pretreatment.

- Use warm water for prewashing stained laundry. (Hot water can set stains.) See pages 13-15 for stain removal information.
- After the Pre-Wash cycle ends, add detergent and set a new wash cycle.



Pre-wash cycle

## Extra Wash cycle

(on some models)

Extra Wash automatically prewashes the laundry and advances into the Heavy cycle. (The washer does not need to be reset after the Extra Wash cycle.) Use this cycle when washing heavily soiled loads that require maximum soil removal.

- For proper cleaning, double the amount of detergent recommended for a wash cycle.

**NOTE:** The machine pauses during Extra Wash. This is normal for washer operation.

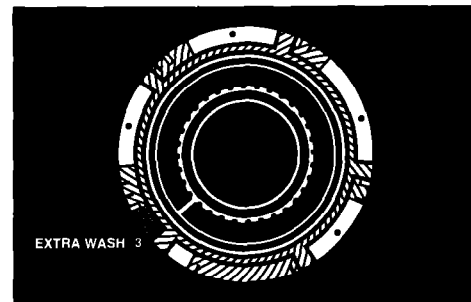

Extra wash cycle

## Using rinse and spin

When using extra detergent for heavily soiled clothes, or washing special-care items, you may want an extra rinse and spin.

1. Push Cycle Control Knob in and turn clockwise to one of the dots on the dial, as illustrated.
2. Pull Cycle Control Knob out. The washer will fill to selected level, agitate, drain, and spin.

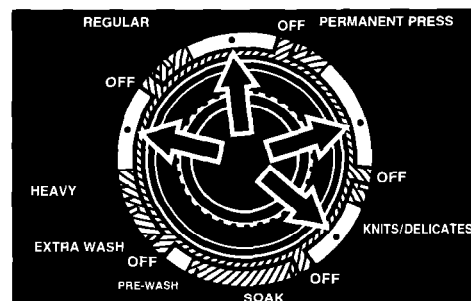

## What happens in each cycle

When the Cycle Control Knob is set to a number and pulled out, the washer fills (to the selected load size) before agitation and timing start. The washer will begin agitating immediately after filling; agitation can occur with the washer lid up or down.

After agitation starts, the Cycle Control Knob turns clockwise until it points to OFF and the cycle ends.

**The washer pauses briefly throughout each cycle.** These pauses are normal for washer operation.

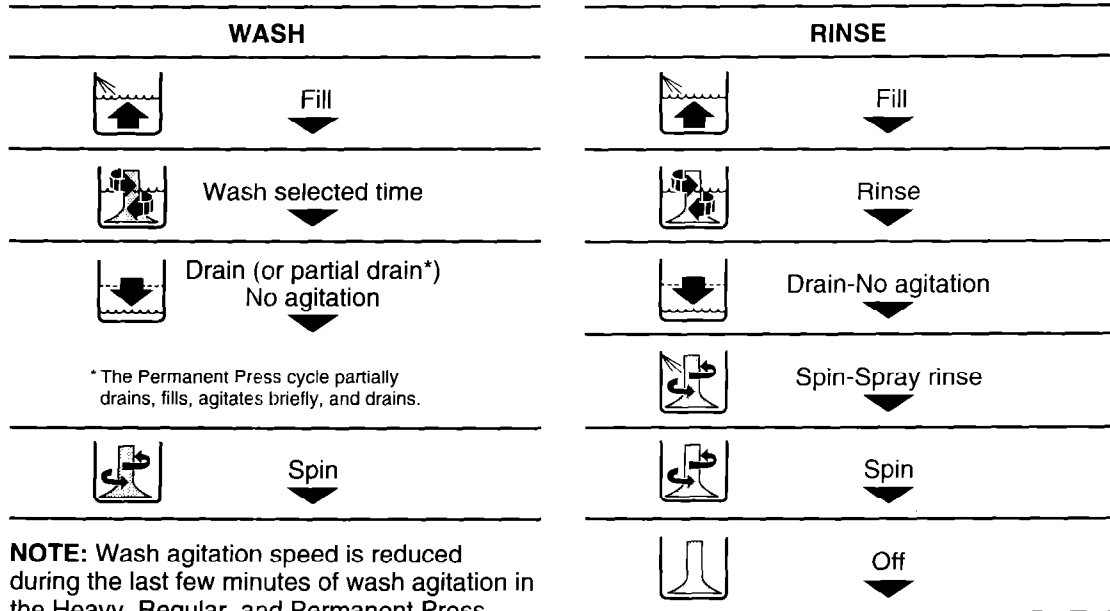

**NOTE:** Wash agitation speed is reduced during the last few minutes of wash agitation in the Heavy, Regular, and Permanent Press cycles. This helps protect your fabrics.

# Other Features

In This Section		Page	Page
Lint filters .....	10	Using the chlorine bleach dispenser .....	11
Using the fabric softener dispenser .....	11		

Your washer may have some of the following features. Understanding the use of the features on your machine will help you efficiently use your washer.

## Lint filters

Your washer has a self-cleaning lint filter (requires no cleaning by you) or a manual clean lint filter. Check the shape of your agitator to see if you need to clean your lint filter.

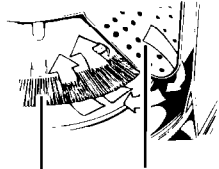
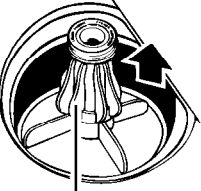
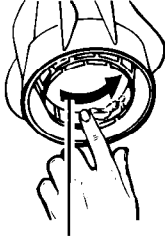
AGITATOR	ABOUT YOUR FILTER	FILTER
 <p><b>Spiral-shaped agitator</b></p>	<p><b>Self-cleaning lint filter</b></p> <p>This lint filter requires no cleaning. (The lint filter at the bottom of the washer basket cleans itself.) During agitation, wash and rinse water pass over the filter, separating the lint from the water. The lint is then spun away from the filter and out of the system during the spin part of the cycle.</p> <p>If your washer drains into a tub, remove any lint collected in the tub or strainer.</p>	 <p><b>Self-cleaning lint filter</b>    <b>Basket interior</b></p>
 <p><b>Barrel-shaped agitator</b></p>	<p><b>Manual clean lint filter</b></p> <p>If your agitator is barrel shaped, as illustrated, your machine has a manual clean lint filter. Clean the filter at the bottom of the agitator after every load for the best filtering results.</p> <p><b>To clean:</b></p> <ol style="list-style-type: none"> <li>1. Lift off the agitator barrel.</li> <li>2. Wash or wipe the filter clean in the bottom of the agitator barrel. The filter is not removable.</li> <li>3. Replace agitator barrel. Snap it into place.</li> </ol>	 <p><b>Manual clean lint filter</b></p>

## Using the fabric softener dispenser

(on some models)

1. Add detergent and load the basket.
  2. Add liquid fabric softener to the dispenser using the amount recommended on the package. Avoid dripping or spilling any fabric softener on the load.
  3. Dilute fabric softener with warm water. Fill dispenser with warm water until liquid reaches the cross-bar at the bottom of the pouring well.
  4. Start the washer. Diluted fabric softener will be added to the load during the final rinse.
- NOTE:** Do not stop the washer before the final rinse begins. Staining can occur.

Flush dispenser periodically with warm water.

- To remove the dispenser, grasp the top of the dispenser with both hands. Squeeze and push upward with thumbs.
- Clean dispenser by holding under water faucet. Replace after cleaning.

**NOTE:** Do not wash clothes with dispenser removed. Do not add detergent or bleach to dispenser. The dispenser can clog.

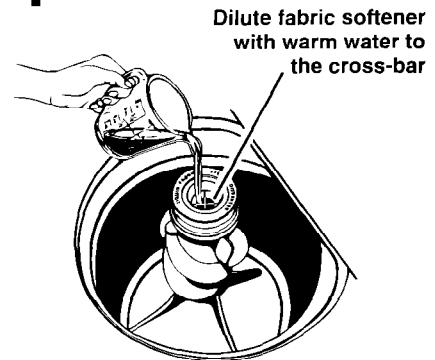

Add fabric softener and water



Clean the dispenser

## Using the chlorine bleach dispenser

(on some models)

Always measure liquid chlorine bleach. Do not guess. Never use more than 1 cup (250 mL) for a full load. Use less with lower water level settings. Follow manufacturer's directions for safe use. Use a cup with a pouring spout to avoid spilling.

1. Load the washer.
2. Pour measured chlorine bleach carefully into dispenser. Do not let bleach splash, drip or run down into washer basket. Undiluted bleach will damage any fabric it touches.
3. Start the washer. Bleach will be diluted automatically during wash part of cycle.

**NOTE:** Do not add powdered chlorine or all-fabric bleach to the dispenser. The dispenser can clog.

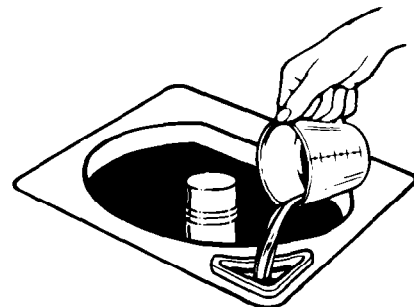

# Laundry Tips

In This Section		Page	Page
Before you wash .....	12	Solving laundering problems .....	20
Removing stains .....	13	Caring for your washer .....	21
Water usage guide .....	16	Care during periods of non-use .....	21
Using laundry aids .....	17	Saving energy .....	21
Washing special-care items .....	18		

This section reviews proper laundering techniques, gives you additional washing information, and discusses solutions to common laundering problems.

## Before you wash

### Preparing clothes for washing

- Close zippers, snaps, and hooks to avoid snagging other items. Remove pins, buckles, and other hard objects to avoid scratching the washer interior. Remove unwashable trim and ornaments.
- Empty pockets and turn them inside out.
- Turn down cuffs and brush away lint and dirt.
- Turn synthetic knits inside out to avoid pilling.
- Tie strings and sashes so they will not tangle.
- Mend tears, loose hems and seams.
- Treat spots and stains. (See page 13 for pretreatment and stain removal information.)
- Stained or wet garments should be washed promptly for best results.

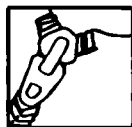

### Sorting

- Separate heavily soiled items from lightly soiled ones even if they would normally be washed together. Separate lint givers (towels, chenille) from lint takers (corduroy, synthetics, permanent press). When possible, turn lint givers inside out.
- Separate dark from light colors, colorfast from noncolorfast.
- Sort by fabric and construction (sturdy cottons, knits, delicate items).



### Loading

- Drop items into washer loosely. Fill to the top of the basket, but do not pack or wrap items around the agitator. Items should move easily through wash water for best cleaning and wrinkle-free results. Watch for rollover. Items should sink and reappear later.
- Load washer properly. Overloading or packing can:
  - cause poor cleaning.
  - increase wrinkling.
  - create excessive lint.
  - wear out items faster (because of pilling).
- Load by the amount of space items take up, not by their weight.
- Mix large and small items in each load. Load evenly to maintain washer balance. An off-balance load can make the machine vibrate during spin. To reduce wrinkling, permanent press and synthetic knits should have more room to move in the water than heavy items (towels, jeans).



**Loading suggestions**

For these suggested full-sized loads, use the largest load size setting.

**LARGE CAPACITY WASHERS**

<p><b>Heavy Work Clothes</b> 2 pair pants 3 shirts 3 pair jeans 1 coverall</p>	<p><b>Permanent Press</b> 1 double sheet 1 tablecloth 1 dress 1 blouse 2 slacks 3 shirts 2 pillowcases</p>	<p><b>Mixed Load</b> 2 double or 1 king size sheet 4 pillowcases 6 T-shirts 6 pair shorts 2 shirts 2 blouses 6 handkerchiefs</p>	<p><b>Towels</b> 8 bath towels 8 hand towels 10 wash cloths 1 bathmat</p>
<p><b>Knits</b> 2 slacks 2 blouses 4 shirts 4 tops 2 dresses</p>			<p><b>Delicates</b> 2 camisoles 4 slips 4 panties 2 bras 2 nighties</p>

**EXTRA LARGE CAPACITY WASHERS**

<p><b>Heavy Work Clothes</b> 3 pair pants 3 shirts 4 pair jeans 1 coverall 1 overall</p>	<p><b>Permanent Press</b> 2 double or 1 king size sheet 1 tablecloth 1 dress 1 blouse 2 slacks 3 shirts 2 pillowcases</p>	<p><b>Mixed Load</b> 3 double sheets 4 pillowcases 8 T-shirts 6 pair shorts 2 shirts 2 blouses 8 handkerchiefs</p>	<p><b>Towels</b> 10 bath towels 10 hand towels 14 wash cloths 1 bathmat</p>
<p><b>Knits</b> 3 slacks 3 blouses 6 shirts 4 tops 4 dresses</p>			<p><b>Delicates</b> 3 camisoles 1 quilted robe 4 slips 4 panties 2 bras 2 nighties 1 baby's dress</p>

**Removing stains**

Stained, heavily soiled or greasy items may need to be prewashed or soaked for best results. Soaking helps remove protein-type stains like blood, milk, or grass. Prewashing helps loosen soil before washing.

**Pre-washing or soaking**

Use warm water for soaking or prewashing stained laundry. Hot water can set stains.

**Stain removal rules**

- Most stains are easier to remove when they are fresh. Old or set stains may not come out. Follow package directions for pretreatment products.
- Before treating any stain, find out ...
  1. What kind of stain it is.
  2. What kind of fabric it is and if it is colorfast. (Check label.)

3. How old the stain is. (Washing and drying can set some stains.)

- Start with cold or warm water. Hot water can set some stains.
- When bleach is recommended, use a bleach that is safe for the fabric. Dilute chlorine bleach.
- Test stain removers on an inside seam or hidden corner of the item to see if the color is removed.
- Put the stained area face down on a paper towel or white cloth. Apply the stain remover to the back of the stain. This can force the stain off the fabric instead of through it.
- Meat tenderizer or enzyme presoaks help break down some protein stains so they are easier to remove.
- Use nonflammable dry cleaning solvents in a well-ventilated room.

## Stain removal guide

STAIN	TO REMOVE
<b>Alcoholic beverage</b>	These stains turn brown with age, so treat immediately. Sponge or soak fresh stains with cold water. Wash. If stain remains, soak 15 minutes in a solution of lukewarm water, liquid detergent and a few drops of white vinegar. Rinse. Wash.
<b>Blood</b>	Rinse immediately or soak in cold water with enzyme presoak for 30 minutes or longer. Rinse. Rub detergent into any remaining stains. Rinse. If stain remains, put a few drops of 3% hydrogen peroxide on stain for 3-5 minutes. Rinse thoroughly. Wash.
<b>Chewing gum</b>	Use ice to make gum hard. Scrape off what you can. Sponge with a nonflammable dry cleaning solvent. Let dry. Wash.
<b>Chocolate or coffee</b>	Sponge immediately with a nonflammable dry cleaning solvent or apply a prewash soil and stain remover. Rinse. Wash. If stain remains, apply a liquid detergent to stain or soak in warm water with an enzyme presoak. Rewash.
<b>Crayon and candle wax</b>	Scrape off excess with a dull knife. Place fabric between two blotters or facial tissue. Press with warm iron. Remove color stain with nonflammable dry cleaning solvent. Hand wash until stain is gone. If full load is crayon stained, take to cleaners or coin-operated dry cleaning machine.
<b>Cream, milk or ice cream</b>	Sponge with a nonflammable dry cleaning solvent, or a prewash soil and stain remover. Rinse. Wash. Repeat if necessary. If stain remains, apply a few drops of liquid detergent and a few drops of ammonia. Blot dry and rinse. If stain remains, soak in an enzyme presoak. Wash.
<b>Deodorants and anti-perspirants</b>	<b>Light stain:</b> Treat with liquid detergent or your regular laundry detergent. Wash in hottest water safe for fabric. <b>Heavy stain:</b> Place face down on towel and treat with a paste of ammonia and all-fabric bleach. Let stand for 30 minutes. Wash in hottest water safe for fabric.
<b>Fat, grease or oil</b>	Items soiled with vegetable or cooking oil should not be washed or dried. See vegetable/cooking oil Warning on page 3. For other types of greasy stains, use one of the methods below: <ul style="list-style-type: none"> <li>• Use pretreatment stain remover. Follow label directions. Wash in hottest water safe for fabric.</li> <li>• Use talcum powder to absorb as much grease as possible. Sponge with a nonflammable dry cleaning solvent. Rinse. Wash.</li> <li>• Treat with liquid detergent or rub a detergent paste on the stain. Wash using hottest water safe for fabric.</li> </ul>
<b>Fruit stains</b>	<b>Fresh stains:</b> Soak immediately in cool water. Wash. If stain remains, cover area with a paste made of all-fabric bleach, a few drops of hot water and a few drops of ammonia. Wait 15 to 30 minutes. Wash. <b>Old stains:</b> Sponge with white vinegar. Rinse. Repeat procedure for fresh stains.
<b>Grass or green vegetables</b>	Soak in warm or cold water with an enzyme presoak for at least 30 minutes, or sponge with denatured alcohol. Wash in water temperature and bleach safe for the fabric. For colored fabrics, check colorfastness before applying alcohol. For acetate, sponge with a nonflammable dry cleaning solvent. If stain remains, bleach with 3% hydrogen peroxide. Rinse. Rewash.
<b>Ink or ballpoint pen ink</b>	Spray stain with an aerosol hair spray or rubbing alcohol. Sponge stain continuously until all bleeding stops. Let dry. Repeat if necessary. Wash. If stain remains, bleach if safe for fabric. (India and other indelible inks are almost impossible to remove completely.)

<b>STAIN</b>	<b>TO REMOVE</b>
<b>Iron or rust</b>	<b>Colored or noncolorfast items:</b> Apply lemon juice and salt. Place in the sun to dry. Rinse thoroughly. Repeat if necessary. <b>White or colorfast items:</b> Try a rust remover. Test first on inside seam or hem. Some rust removers are not washer safe. Follow package directions.
<b>Ketchup or tomato products</b>	Sponge immediately with a nonflammable dry cleaning solvent or apply a prewash soil and stain remover. Rinse. Wash. If stain remains, apply a liquid detergent to stain or soak in warm water with an enzyme presoak. Rewash.
<b>Lipstick</b>	Apply nonflammable dry cleaning solvent or prewash soil and stain remover. Blot with absorbent material. Repeat if necessary. Rinse. If stain still remains, rub with liquid detergent. Wash.
<b>Meat juice, egg</b>	Scrape off excess with a dull knife. Soak in cold or warm water with enzyme presoak at least 30 minutes, or treat stains with a nonflammable dry cleaning solvent. Wash.
<b>Mildew</b>	Wash in hottest water safe for fabric. If stain remains, soak in warm water and an all-fabric bleach for 15 to 30 minutes. Rewash. (Old mildew stains are almost impossible to remove. Mildew fungus destroys or weakens fabrics.) An alternative to bleach is to treat with salt and lemon juice and dry in direct sunlight. Rinse and rewash. Mildew may form if wet or damp laundry remains in your washer for extended periods of time. To prevent mildew, promptly dry laundry after washing.
<b>Mustard</b>	Treat immediately. Scrape off excess mustard. Sponge with a nonflammable dry cleaning solvent or a prewash soil and stain remover. Rinse. Work liquid detergent and a few drops of vinegar into stain. Rinse. If stain remains, apply 3% hydrogen peroxide. Rinse and wash.
<b>Paint</b>	Hand wash paint-stained items. <b>Water base:</b> Treat stains while still wet. (These paints cannot be removed after they have dried.) Rinse in warm water to flush out paint. Sponge with a nonflammable dry cleaning solvent. Rinse. Wash. <b>Oil base:</b> Scrape off fresh paint. Sponge with a nonflammable dry cleaning solvent or treat stain with recommended thinner. While stain is still wet with solvent, rub liquid detergent into it. Wash with hottest water safe for fabric.
<b>Perspiration</b>	Remove stains before ironing. Perspiration stains may weaken fabric. Wash or sponge stain thoroughly with detergent and warm water. If perspiration has changed the color of the fabric, use one of the following treatments: <b>Fresh stains:</b> Apply ammonia to stain. Rinse. Launder to remove ammonia odor. <b>Old stains:</b> Apply white vinegar to stain. Rinse. Launder to remove vinegar odor.
<b>Scorch</b>	Severe scorch cannot be removed. Wet stain with 3% hydrogen peroxide. Cover with a dry cloth and press with an iron as hot as is safe for fabric. Rinse well. Wash. <b>OR</b> Wet with lemon juice and spread in the sun to dry. Wash.
<b>Soft drinks</b>	Sponge immediately with cold water and alcohol. Heat and detergent may set stain.

## Water usage guide

### Water temperature

WASH	RINSE	USE FOR	COMMENTS
<b>HOT</b> 130°F (54°C) or above	<b>COLD</b>	<ul style="list-style-type: none"> <li>• Heavy soils</li> <li>• Work clothes</li> <li>• Sturdy whites and colorfast pastels</li> <li>• Diapers</li> </ul>	<ul style="list-style-type: none"> <li>• Gives best cleaning for heavy soils.</li> <li>• Removes oils, perspiration, greasy soils and stains.</li> <li>• Prevents graying and yellowing.</li> </ul>
<b>WARM</b> 90°-110°F (32°-44°C)	<b>COLD</b>	<ul style="list-style-type: none"> <li>• Light and moderate soils</li> <li>• Dark or noncolorfast colors</li> <li>• Moderately soiled permanent press</li> <li>• Nylons, polyesters, acrylics, silks, woolens</li> <li>• Knits and delicate fabrics</li> <li>• Prewash, soak</li> </ul>	<ul style="list-style-type: none"> <li>• Safe for most fabric finishes.</li> <li>• Less fading and dye bleeding.</li> <li>• Reduces wrinkling.</li> </ul>
<b>COLD</b> 70°-90°F (21°-32°C)	<b>COLD</b>	<ul style="list-style-type: none"> <li>• Very lightly soiled items</li> <li>• Moderately soiled items if extra detergent is added</li> <li>• Extra sensitive colors (noncolorfast)</li> <li>• Rinsing, for all fabrics</li> </ul>	<ul style="list-style-type: none"> <li>• Saves hot water.</li> <li>• Less effective cleaning than hot or warm water.</li> <li>• Use longest wash time in cycle selected.</li> <li>• Use liquid detergent, or dissolve powdered detergent in warm water before adding to cold wash water.</li> <li>• Pretreat spots, stains and heavy or greasy soils.</li> </ul>

#### To check your hot water temperature with a candy or cooking thermometer:

1. Fill a pan with the hottest water available from the faucet that will fill your washer.
2. Place a candy or cooking thermometer in water to check the temperature.

If you do not have a faucet at your wash site, collect water from the faucet closest to your washer.

**NOTE:** In wash-water temperatures colder than 70°F (21°C):

- Detergents do not dissolve well.
- Soils are difficult to remove.
- Some fabrics will retain wear wrinkles and may have increased pilling.

#### Water hardness

Many poor washing results can be traced to wash-water hardness. To check your water hardness:

- City water—ask your city water company.
- Well water—call your Cooperative Extension Service.

Ask for the mineral content in grains-per-gallon or parts-per-million. If your water is 9 or more grains-per-gallon or more than 153 parts-per-million:

- Consider installing a water softener.
- Use more detergent.
- Use a packaged water conditioner.
- Do not use soap.

## Using laundry aids

Follow package instructions when using laundry aids. (See "Removing Stains" on page 13, for more information.)

### Chlorine bleach

- Use bleach dispenser if your machine has one. (See page 11.)
- If your washer does not have a bleach dispenser:
  1. Let the washer fill and begin agitating the load.
  2. Measure bleach. Never use more than 1 cup (250 mL) for a full load. Dilute measured bleach in 1 quart (1L) of water.
  3. Add bleach to wash cycle so it can be removed in the rinse cycle. Pour bleach around agitator, not directly on load.
- Follow directions on care labels. Do not use chlorine bleach on wool, silk, spandex, acetates or some flame-retardant fabrics.
- When soaking with chlorine bleach, add detergent to soak water.

**NOTE:** Undiluted bleach will damage any fabric it touches. The damage appears as rips, holes, tears or color loss and may not show up until several washings later.

### All-fabric bleach

- Powdered or liquid all-fabric bleach may be used on all types of fabrics.
- Do not use all-fabric bleach in the bleach dispenser because it may clog.

### Detergent

- Using too little detergent is a common cause of laundry problems. Follow manufacturer's directions. Measure accurately, especially when using ultra detergents. Package directions are usually based on:
  - moderate water hardness (4-6 grains)
  - lightly soiled items
  - normal mix loads.
- Use more detergent for:
  - hard water
  - cooler wash water
  - full loads
  - heavily soiled items.
- Do not judge the amount of detergent to use by the amount of suds in the machine. Low sudsing detergents do not create as many suds as normal sudsing detergents.

- If the recommended amount of normal sudsing detergent creates too many suds or suds are present in the rinse water, try a low sudsing detergent.

### Fabric softeners

- Use fabric softener dispenser if your machine has one.
- If your washer does not have a fabric softener dispenser, add diluted fabric softener only in the final rinse.
- Always dilute fabric softeners with 1/2 to 1 cup (125 to 250 mL) warm water. Undiluted fabric softener can stain fabrics.
- Fabric softeners should not be mixed with other laundry products because greasy stains may form. If stains form, remove by wetting the stain and rubbing with liquid detergent or a bar of soap. Rewash the stained item.
- Too much fabric softener can make some items (diapers and towels) nonabsorbent. If this happens, use less fabric softener or do not use it every time.

## **WARNING**

### Fire or Explosion Hazard

- Store flammable solvents or liquids away from your washer.
- Dry cleaning solvents or fluids should not be put directly into your washer.
- Items treated with solvents should be rinsed and air dried before washing in your washer.

The fumes from these substances can create a fire hazard or explosion.

### Personal Injury Hazard

- Never use chlorine bleach with ammonia or acids. Hazardous fumes can form.
- Keep stain removal products out of the reach of children ... preferably in a locked cabinet.

## Washing special-care items

Most garments and household textiles have care labels with laundering instructions. Always follow label directions when they are available. General washing instructions for some special washables are included in this section.

<p><b>Blankets, electric and woolen</b></p>	<p>Pretreat spots and stains. Select water temperature, cycle, and time according to the type of blanket being washed. Two rinses may be necessary. If manufacturer recommends machine washing:</p> <ol style="list-style-type: none"> <li>1. Measure blanket before washing.</li> <li>2. Add mild detergent to washer. Fill and agitate briefly to dissolve detergent.</li> <li>3. Stop washer. Load blanket evenly around agitator. Soak 10 to 15 minutes.</li> <li>4. Set Cycle Control Knob to drain and spin just beyond any dot on the dial. Start washer. Spin 1 to 2 minutes.</li> <li>5. Fill washer for final rinse. Stop washer. Allow to soak.</li> <li>6. Set Cycle Control Knob as you did in Step 4. Start washer. Allow washer to finish cycle.</li> <li>7. Lay blanket on flat surface and block by gently stretching to original measurement. Woolens tend to shrink more the first time they are washed. This is normal.</li> </ol>
<p><b>Curtains, drapes, slipcovers</b></p>	<p>Wash small loads. Crowding will cause wrinkling.</p> <ol style="list-style-type: none"> <li>1. Shake or vacuum to remove loose dirt.</li> <li>2. Wash following manufacturer's instructions.</li> </ol> <p><b>NOTE:</b></p> <ul style="list-style-type: none"> <li>• Sun-damaged curtains and draperies will tear whether hand or machine washed.</li> <li>• Replace slipcovers while still slightly damp. They will dry to fit tightly.</li> </ul>
<p><b>Diapers</b></p>	<p>When using chlorine bleach for soaking, add detergent to load. Avoid overuse of fabric softeners. Absorbency will be reduced.</p> <ol style="list-style-type: none"> <li>1. Rinse immediately. Soak in a solution of lukewarm water and a small amount of detergent until you are ready to wash them. You may wish to use bleach or a special soaking product when soaking.</li> <li>2. Spin excess water from diapers before washing.</li> <li>3. Wash diapers as you would wash white cottons and linens.</li> </ol>
<p><b>Elastic, spandex</b></p>	<p>Elastic picks up oil from the body. Oil can damage elastic. Wash often to help reduce the damage. Use warm water and sufficient detergent to remove oils.</p>
<p><b>Flame-retardant clothing</b></p>	<p>Items will be clearly labeled as flame-retardant. Follow manufacturer's instructions to retain flame retardant qualities.</p>

<b>Fiberglass materials</b>	Do not wash fiberglass materials in your washer. Glass particles could stick to the next load and cause skin irritation.
<b>Knits</b>	Knits are comfortable to wear because they stretch. However, this means that knits are more likely to be stretched and damaged when washed (especially bulky knits). Knits made of synthetic fabrics such as polyester, nylon, and acrylic tend to keep their original shape more than a knit made of cotton or ramie. <ol style="list-style-type: none"> <li>1. Close zippers, fasten hooks and eyes to prevent snagging.</li> <li>2. Wash small loads to reduce pilling and lint.</li> </ol>
<b>Pillows, stuffed toys</b>	Washing feather pillows is not recommended unless they are dryer dried. <ol style="list-style-type: none"> <li>1. Add detergent, then partially fill washer with water; agitate until detergent is dissolved.</li> <li>2. Place two pillows on opposite sides of the agitator to balance the load.</li> <li>3. Allow washer to fill completely and continue through the cycle.</li> <li>4. Stop the washer occasionally to press air from item(s) being washed.</li> </ol>
<b>Plastic, rubber items</b>	Treat as delicate items. Wash in warm water. Wash small items in a mesh bag.
<b>Quilts, bedspreads</b>	Do not wash cotton-filled comforters unless they are quilted or stitched; tucked cotton batting tends to slip and become lumpy.
<b>Scatter rugs</b>	<ol style="list-style-type: none"> <li>1. Shake or vacuum to remove loose dirt.</li> <li>2. Wash more than one small rug at a time. If you wash only one rug, add bath towels to balance the load. A larger rug should be distributed around the agitator to balance the load.</li> </ol>
<b>Snowsuits, jackets, etc.</b>	<ol style="list-style-type: none"> <li>1. Wash only one or two items at a time. Load evenly around the agitator.</li> <li>2. Stop the washer occasionally to press air from item(s) being washed.</li> <li>3. Two rinses may be necessary.</li> </ol>

## Solving laundering problems

Most laundering problems are easily solved if you understand the cause. Check the following list for problems you may have and possible causes. If you need additional help, check the "Assistance or Service" section of this book.

<b>PROBLEM</b>	<b>CAUSE</b>
<b>Brown, yellow stains</b>	<ul style="list-style-type: none"> <li>• Chlorine staining</li> <li>• Iron in water heater or pipes</li> <li>• Iron and manganese in water</li> </ul>
<b>Dye transfer</b>	<ul style="list-style-type: none"> <li>• Improper sorting</li> <li>• Load not immediately removed from washer after end of cycle</li> </ul>
<b>Gray whites, dingy colors</b>	<ul style="list-style-type: none"> <li>• Improper sorting</li> <li>• Water temperature too low</li> <li>• Not enough detergent</li> <li>• Using soap in very hard water (use detergent if you have hard water)</li> </ul>
<b>Greasy looking spots</b>	<ul style="list-style-type: none"> <li>• Undiluted fabric softener or fabric softener poured directly on load</li> <li>• Fabric softener in wash water</li> <li>• Not enough detergent</li> </ul>
<b>Lint</b>	<ul style="list-style-type: none"> <li>• Improper sorting</li> <li>• Paper or tissue in pockets</li> <li>• Pilling being mistaken for lint</li> <li>• Overloading</li> <li>• Not enough detergent</li> <li>• Clogged lint filter (models with a manual clean lint filter)</li> </ul>
<b>Load too wet after spin</b>	<ul style="list-style-type: none"> <li>• Cold rinses</li> <li>• Lid is opened before spinning is completed</li> </ul>
<b>Shrinking</b>	<ul style="list-style-type: none"> <li>• Fabric type (some knits stretch during manufacturing—laundering returns fabric to original size)</li> <li>• Care label directions not followed</li> </ul>
<b>Snags, rips, holes</b>	<ul style="list-style-type: none"> <li>• Items damaged before washing</li> <li>• Misuse of chlorine bleach</li> <li>• Sharp articles not removed from pockets</li> <li>• Overloading</li> <li>• Fasteners not fastened</li> </ul>
<b>Stiff, rough fabrics (usually cottons)</b>	<ul style="list-style-type: none"> <li>• Using soap in very hard water (use detergent if you have hard water)</li> <li>• Not enough detergent</li> <li>• Line drying</li> </ul>
<b>Twisting, tangling</b>	<ul style="list-style-type: none"> <li>• Overloading</li> <li>• Improper loading (do not wrap large items around agitator)</li> </ul>
<b>Wrinkling</b>	<ul style="list-style-type: none"> <li>• Overloading</li> <li>• Load not immediately removed from washer after end of cycle</li> <li>• Improper rinse temperature</li> <li>• Cycle selection is incorrect (based on fabric type)</li> </ul>
<b>Yellow areas (from body oils)</b>	<ul style="list-style-type: none"> <li>• Water temperature too low</li> <li>• Not enough detergent</li> </ul>

## Caring for your washer

- Wipe up detergent, bleach, and other spills with a soft, damp cloth or sponge as they occur.
- Remove hard water deposits using only cleaners labeled as washer safe.
- If the washer interior needs cleaning (for example, after tinting or dyeing), put 1 cup (250 mL) of chlorine bleach and 2 cups (500 mL) of detergent in the washer. Run through a complete cycle using hot water. If staining occurs on following loads, repeat the process.
- Sharp or heavy objects can damage your washer. Check pockets for bolts, nuts, etc. Do not lay these objects on your washer after emptying pockets.

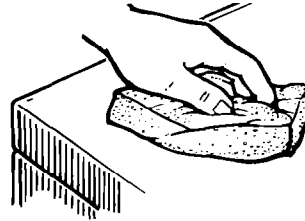

**NOTE:** Operate your washer only when you are at home.

## Care during periods of non-use

### Winter storage or moving care

Install and store your washer where it will not freeze. Because some water stays in the washer, freezing can damage it. If your washer is stored or moved during freezing weather, winterize it.

1. Shut off both water faucets. Disconnect the drain water inlet hoses.
2. Put 1 quart (1 L) of R.V.-type antifreeze in the basket.
3. Push in and turn the Cycle Control Knob clockwise to just beyond any dot on the dial. (See "Using rinse and spin" on page 8.)
4. Pull out the Cycle Control Knob and allow the washer to run about 30 seconds to mix the antifreeze and water.
5. Unplug power supply cord.

### To use the washer again:

1. Flush water pipes and hoses.
2. Reconnect water inlet hoses.
3. Turn on both water faucets.
4. Reconnect power supply cord.
5. Run the washer through a complete cycle with 1 cup (250 mL) of detergent to clean out antifreeze.

### Non-use/vacation care

1. Unplug power supply cord or turn off electrical power.
2. Turn off water supply leading to your washer. This will help avoid accidental flooding while you are away (for example, due to a water pressure surge).

## Saving energy

- Use warm or cold wash water for most loads. Use hot water only when washing heavy, greasy soils or whites.
- Use cold rinses.
- Wash full loads.
- Use lower water levels when washing small loads.
- Avoid rewashing. Use enough detergent; pretreat stains or heavy soils; do not overload; use the cycles and wash times recommended for the fabric and soil; sort properly.
- Use your washer during off-peak hours—usually early morning and late evening. (Ask your power company.)

# If You Need Assistance Or Service

## 1. Before calling for assistance ...



Is your water turned on?



Is the power cord plugged in?

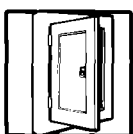

Have you blown a fuse or tripped the circuit breaker?

If you need more help, check the chart below.

PROBLEM	CHECK THE FOLLOWING
<b>Washer will not fill</b>	Is the power cord firmly plugged into a live circuit with proper voltage? Has a household fuse blown or circuit breaker tripped? Has a time-delay fuse been used? Are both hot and cold water faucets open? Are the water supply hoses kinked? Is the Cycle Control Knob set and pulled out?
<b>Washer does not spin</b>	Is the lid closed? Is the power cord firmly plugged into a live circuit with proper voltage? Has a household fuse blown or circuit breaker tripped? Has a time-delay fuse been used?
<b>Washer stops during a cycle</b>	Washer pauses briefly at different times in each cycle. These pauses are normal. Is the power cord firmly plugged into a live circuit with proper voltage? Has a household fuse blown or circuit breaker tripped? Has a time-delay fuse been used?
<b>Washer fills and drains without running</b>	Is the Cycle Control Knob pointing to a number in the cycle?
<b>Washer drains during wash and rinse cycles, or water siphons out</b>	Adjust the drain hose so it is higher than the water level in the washer.

**2. If you need assistance\* ...**

Call our toll-free number. Dial free from anywhere in the U.S.A.:

**1-800-44-ROPER  
(1-800-447-6737)**

and talk with one of our trained consultants. The consultant can instruct you in how to obtain satisfactory operation from your appliance or, if service is necessary, recommend a qualified service company in your area.

If you prefer, write to:

Mr. William Clark  
Consumer Assistance Representative  
Roper Brand Appliances  
2000 M-63  
Benton Harbor, MI 49022

Please include a daytime phone number in your correspondence.

**3. If you need service\* ...**

Contact the dealer from whom you purchased the appliance or the authorized servicer in your area. For help finding an authorized servicer in your area, call our toll-free telephone number in Step 2.

**\* When asking for help or service:**

Please provide a detailed description of the problem, your appliance's complete model and serial numbers and the purchase date. (See page 2.) This information will help us respond properly to your request.

**4. If you are not satisfied with how the problem was solved ...**

- Contact the Major Appliance Consumer Action Panel (MACAP). MACAP is a group of independent consumer experts that voices consumer views at the highest levels of the major appliance industry.
- Contact MACAP only when the dealer, authorized servicer and Roper Brand Appliance warrantor have failed to resolve your problem.  
Major Appliance Consumer Action Panel  
20 North Wacker Drive  
Chicago, IL 60606
- MACAP will in turn inform us of your action.

# ROPER®

## Automatic Washer Warranty

LENGTH OF WARRANTY	WHAT WE WILL PAY FOR
<b>FULL ONE-YEAR WARRANTY</b> (from date of purchase)	Replacement parts and repair labor to correct defects in materials or workmanship. Service must be provided by an authorized Roper service company.
<b>LIMITED 2ND-5TH YEAR WARRANTY</b> (from date of purchase)	Replacement parts for any part of the gearcase assembly if defective in materials or workmanship.
WHAT WE WILL NOT PAY FOR	
<p><b>A.</b> Service calls to:</p> <ol style="list-style-type: none"> <li>1. Correct the installation of your washer.</li> <li>2. Instruct you how to use your washer.</li> <li>3. Replace house fuses or correct house wiring or plumbing.</li> </ol> <p><b>B.</b> Repairs when your washer is used in other than normal, single-family household use.</p> <p><b>C.</b> Pickup and delivery. Your washer is designed to be repaired in the home.</p> <p><b>D.</b> Damage to your washer caused by accident, misuse, fire, flood, acts of God, or use of products not approved by us.</p> <p><b>E.</b> Any labor costs during the limited warranty.</p> <p><b>F.</b> Repairs to parts or systems caused by unauthorized modifications made to the appliance.</p>	
<small>8-92</small>	

This Roper appliance is warranted by Whirlpool Corporation. Under no circumstances shall it be liable under this warranty for incidental or consequential damages and all implied warranties are limited to the same time period stated in the express warranties for Roper Brand Appliances. Some states do not allow the exclusion or limitation of incidental or consequential damages, so this limitation or exclusion may not apply to you.

This warranty gives you specific legal rights, and you may also have other rights which vary from state to state.

Outside the United States, a different warranty may apply. For details, please contact your authorized Roper distributor or military exchange.

If you need service, first see the "Assistance or Service" section of this book. After checking "Assistance or Service," additional help can be found by calling our toll-free telephone number, **1-800-44-ROPER (1-800-447-6737)**, from anywhere in the U.S.A.

**PART NO. 3357473**

© 1993 Whirlpool Corporation

® Registered Trademark of Whirlpool Corporation.

Printed in U.S.A.