

This Owner's Manual is provided and hosted by [Appliance Factory Parts](http://www.appliancefactoryparts.com).



Bissell 3301 Owner's Manual

[Shop genuine replacement parts for Bissell 3301](#)



[Find Your Bissell Vacuum Cleaner Parts - Select From 376 Models](#)

----- Manual continues below -----



User's Guide

Models 3300 Series
3301 Series
3302 Series

- Assembly
- Operation
- Recharging
- Maintenance
- Safety

Thanks for buying a BISSELL Go Vac Rechargeable Cordless Sweeper.

We're glad you purchased a BISSELL® Go Vac Rechargeable Cordless Sweeper. Everything we know about home care and cleaning went into the design and construction of this handy appliance.

Your Go Vac is well made, and we back it with a full one-year warranty. We also stand behind it with a knowledgeable, dedicated Consumer Service Department, so, should you ever have a problem, you'll receive fast, considerate assistance.

My great-grandfather invented the floor sweeper in 1876. Today, BISSELL is a global leader in the design, manufacture, and service of high quality homecare products like your Go Vac.

Thanks again, from all of us at BISSELL.

Mark J. Bissell
President and Chief Executive Officer

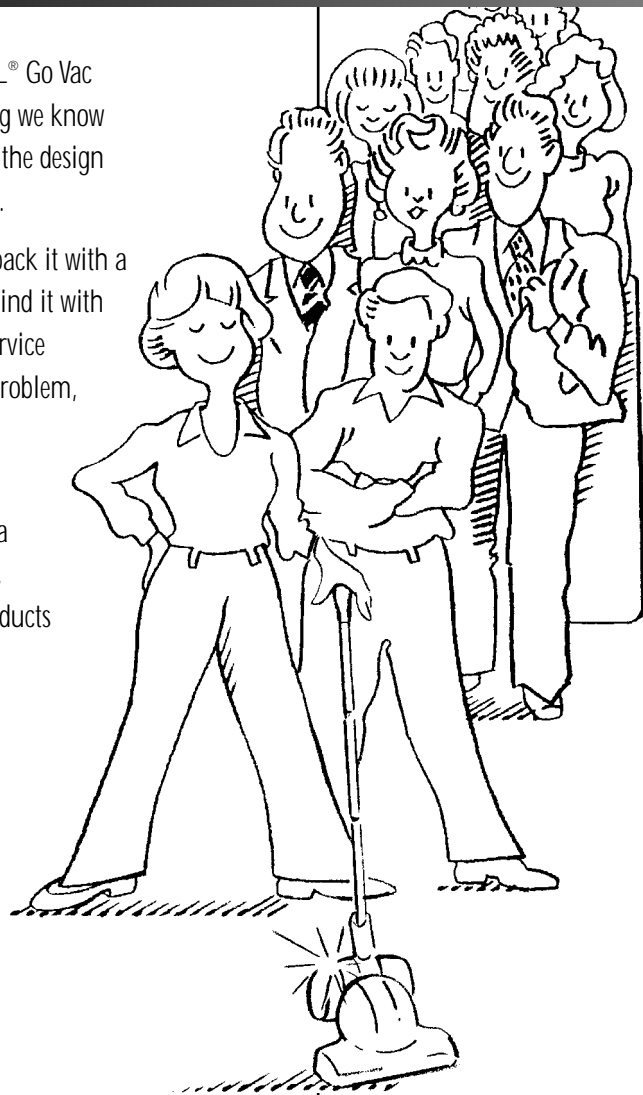

- Easy to use for quick cleanups
- Washable Filter
- Automatic On/Off
- Stores anywhere

IMPORTANT SAFETY INSTRUCTIONS

⚠ WARNING: When using an electrical appliance, basic precautions should be observed, including the following:

Read all instructions before using your BISSELL Go Vac. To reduce the risk of fire, electric shock or injury:

- Store indoors.
- Do not expose to rain.
- Do not immerse or use on wet surfaces.
- Do not handle with wet hands.
- Do not use Go Vac if it has been dropped, damaged, left outdoors or dropped into water - return it to a Service Center.
- Do not use with damaged charging base.
- Do not damage the charging cord. Never carry or pull by the cord, use cord as a handle, close door on cord, or pull cord around sharp edges or corners. Keep cord away from heated surfaces.
- Do not use an extension cord. Charging base cord or DC adapter should plug directly into electrical outlet.
- Do not put any object into appliance openings, use with blocked opening, or restrict air flow. Do not use with any opening blocked.
- Do not use without filter in place.
- Do not expose hair, loose clothing, fingers or body parts to openings or moving parts.
- Do not pick up hot, burning or smoking objects such as cigarettes, matches or hot ashes.
- Do not pick up flammable or combustible materials (lighter fluid, gasoline, kerosene, etc.) or use in the presence of explosive liquids or vapor.
- Do not use appliance in an enclosed space filled with vapors given off by oil base paint, paint thinner, some moth proofing substances, flammable dust, or other explosive or toxic vapors.
- Do not pick up toxic material (chlorine bleach, ammonia, drain cleaner, gasoline, etc.).
- Do not allow to be used as a toy. Close attention is necessary when used by or near children.
- Do not use for any purpose other than described in this User's Guide.

- Use only manufacturer's recommended attachments - use of attachments not provided or sold by BISSELL may cause fire, electric shock or injury.
- Use only the charging base/cord or DC adapter supplied by BISSELL to recharge your Go Vac.
- Use charger unit only in standard electrical outlet (120v - 60hz).
- Keep openings free of dust, lint, hair, etc.
- Disconnect Go Vac from charging base before maintenance or cleaning.
- Be extra careful when cleaning stairs.

This portable hand vacuum contains rechargeable nickel cadmium batteries. Do not incinerate batteries or they will explode when exposed to high temperatures.

Battery cell leaks can occur under extreme conditions. If battery cell liquid comes in contact with the skin:

- Wash immediately with soap and water. Then . . .
- Neutralize with a mild acid such as vinegar or lemon juice.

If battery cell liquid gets into the eyes:

- Flush immediately with clean water for a minimum of 10 minutes.
- Seek medical attention.

SAVE THESE INSTRUCTIONS.

This model is for household use only.

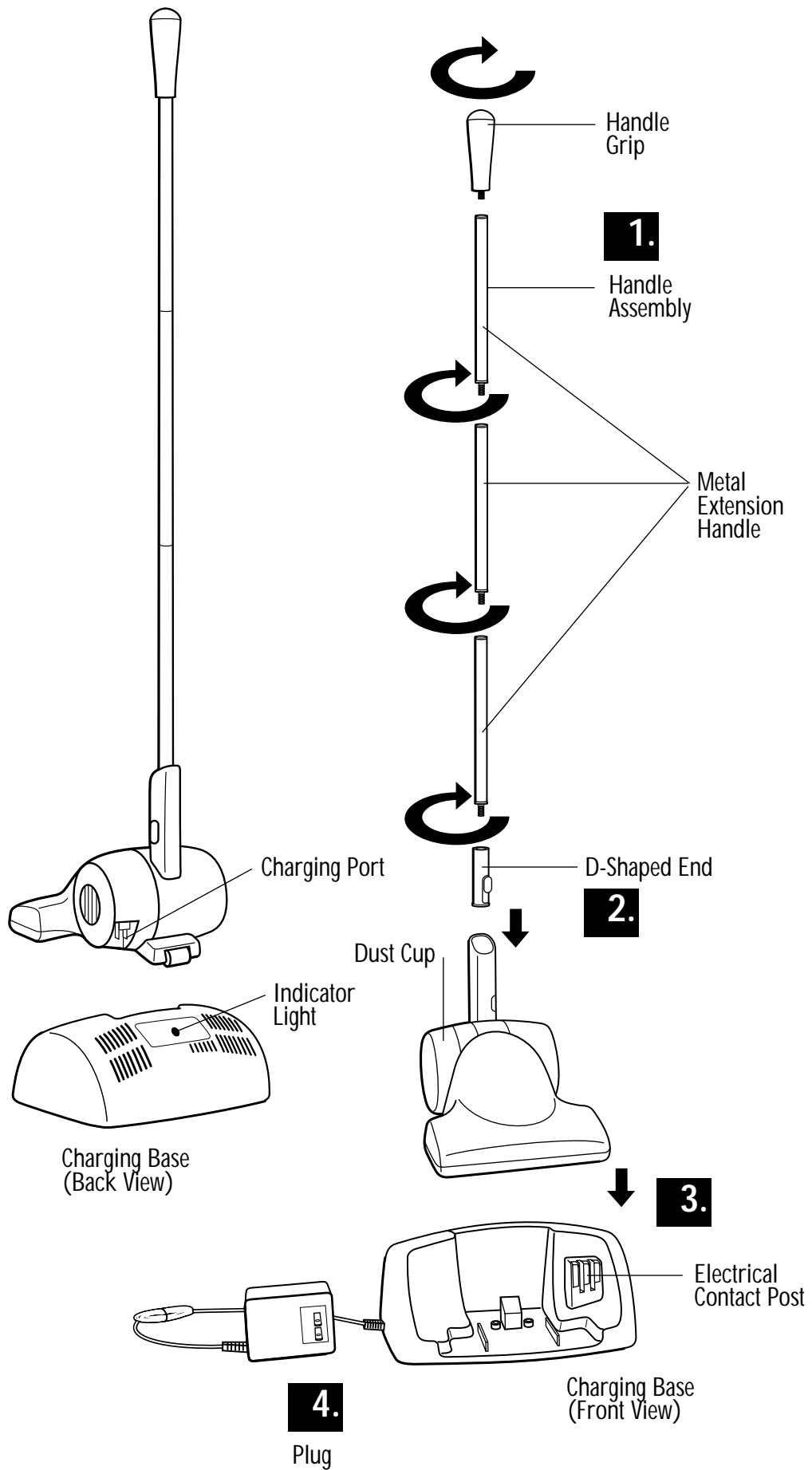

How to use this guide

This User's Guide has been designed to help you get the utmost satisfaction from your Go Vac Rechargeable Cordless Sweeper. Enclosed you'll find assembly instructions, tips for all cleaning tasks, safety precautions, plus maintenance and troubleshooting instructions.

Please read this Guide thoroughly before using your Go Vac. Pay particular attention to the parts diagram, assembly instructions, and part names. Following the Guide will greatly enhance your ability to get the most performance from your Go Vac for many years.

Before you start

Your Go Vac requires very little assembly. Remove it from the box and check it against the illustration to familiarize yourself with the components listed. The exploded view drawing with part names will also be helpful if you should need to order a part at a later time. Remember, components of your Go Vac may vary depending on the model you purchased.

Quick and easy assembly

- 1.** Assemble the Handle by screwing together the three (3) Metal Extension Handles. Place the colored Handle Grip on top of the metal extension assembly and twist clockwise until secure. Screw the D-shaped End to the bottom of the Metal Extension Handle assembly.
- 2.** Place bottom D-shaped End into the D-shaped opening at the top of the Go Vac. Push firmly until the button at the bottom "clicks" into place in the opening.
- 3.** Position Go Vac in Charging Base (if so equipped), making sure that the Go Vac Charging Port fits securely over the Electrical Contact Post on the Charging Base.
- 4.** Plug the Charging Base cord into a standard electrical outlet. The Indicator Light will glow red, showing that the unit is charging.

NOTE: If you purchased Model 3301, the Charging Base is replaced by a Charging Cord with Transformer Plug. The Transformer plugs into standard electrical outlet (120v-60hz); plug the opposite end into the port on the motor side of your Go Vac. Your Go Vac is now charging.

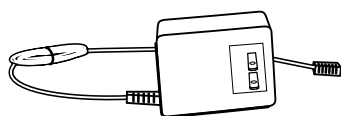

Model 3301 Charging Cord with Transformer Plug

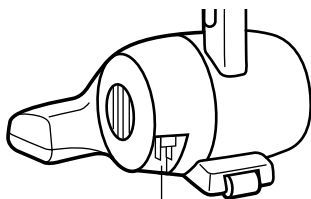

Plug into Port on the Motor side of your Go Vac

⚠WARNING:

Electric/electronic appliances should not be subjected to extreme temperatures or high humidity. Do not store your Go Vac in bathing areas or close to stoves, furnaces or radiators.

Tip:

Fully charge unit before using. (See Charging the battery, page 6.)

Index

Safety instructions	2
Product view	3
Assembly Instructions	4
Product features	5
Index	5
Charging the battery	6
How to use your Go Vac	6
Maintenance	7
Troubleshooting	8
Replacement parts	9
Warranty	10
Consumer services	10

Other components:

NOTE: Components may vary depending on which Go Vac model you purchased. Some models include a convenient Charging Base, while others simply plug into a grounded outlet.

Storage/ Charging Base -
Stores on flat surface and plugs into standard electrical outlet (120v - 60hz).

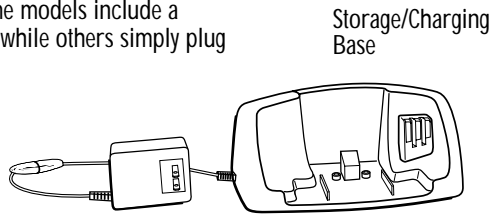

Indicator Light - Glows red when Go Vac is charging.

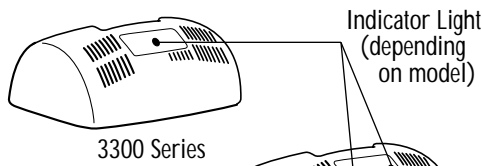

Indicator Light - Glows green when Go Vac is charged and ready for use.

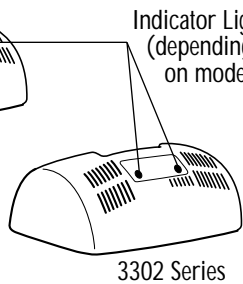

Charging Cord with DC Adapter Plug -
Transformer plugs into standard electrical outlet (120v - 60hz); plug opposite end into port on motor side of Go Vac.

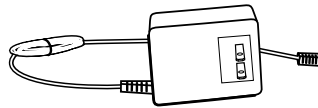

Charging Cord with DC Adapter Plug (3301 Series)

Dust Cup - Press and turn to lock.

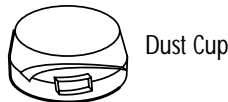

Washable Filter - Fits inside Dust Cup.



Rotating Brush.

Dust Blade.

Metal Extension Handle (five pieces).

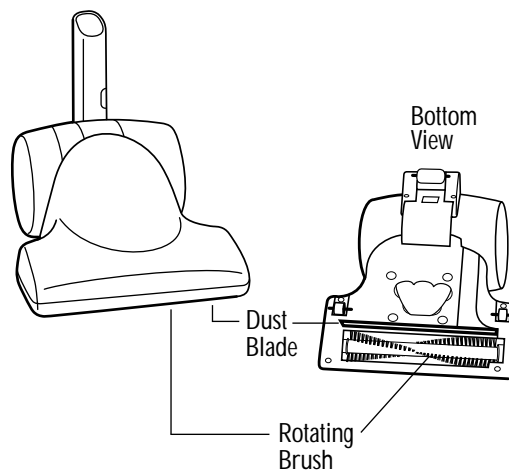
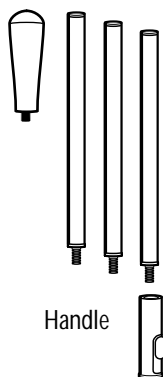

Charging the battery

Your Go Vac may be stored in the Charging Base whenever it is not in use. When Go Vac is charging, it may become warm to the touch. This is normal, and no cause for concern. Here are some things to remember about charging:

1. When completely charged, your Go Vac provides over 12 minutes of full cleaning power.
2. When charging for the first time, allow to charge uninterrupted for at least 24 hours. Thereafter, a 12 -16 hour charge will renew the Go Vac battery.
3. Model 3300 features a single red Indicator Light. This light does not go off when the Go Vac is fully charged. Unplugging the Charging Base cord from the wall outlet after 6 - 8 hours will extend the life of the battery.
4. Model 3302 [Fast Charger] features a red and a green Indicator Light. When in charge mode, the red light will glow. When the battery is fully charged and ready for use, the red light will go out and the green light will glow - usually in 3 hours.

IMPORTANT NOTE: If you purchased a 3302 Go Vac unit equipped with the fast charger, you should let the vacuum cool down before placing into the charging base. The charger features a heat sensitive device that will indicate to the vacuum that it is already charged. (Placing the unit while warm, into the vase will take longer to charge.)

5. Decreased operating time may indicate that the battery has built up a charging resistance. To recharge, first completely exhaust the battery, recharge it, then exhaust it again before recharging a second time. This procedure may be required more than once. If your battery still fails to recharge, or does not hold a charge of normal duration, call:

BISSELL Consumer Services

1-800-237-7691

Monday - Friday 8 a.m. — 7 p.m. EST

Saturday 9 a.m. — 2 p.m. EST

Or visit our website @ www.bissell.com

NOTE: Charging Bases are not interchangeable between models.

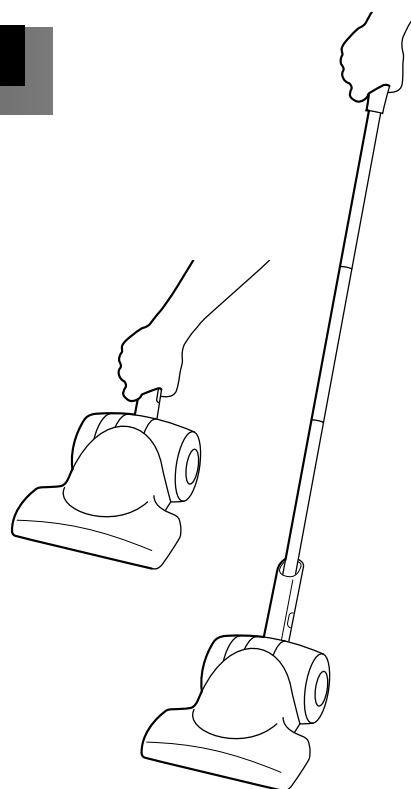

How to use your Go Vac

Your Go Vac is a quick and easy way to clean up around the house, inside the car or truck, or in the workroom.

1. Release the Go Vac from the Charging Base by lifting it straight up and out.
2. Tip back the Handle into typical use position, and your Go Vac turns on by itself. To turn Go Vac off again, return Handle to upright position.
3. To clean stairs, vehicles or small areas, detach the Handle by depressing the button where the bottom of the Handle slides into the Go Vac, and pull the entire Handle assembly out. Use the Go Vac by holding the built-in hand grip.
4. When done, replace the Handle (if detached) and place the Go Vac in the Charging Base. Make certain red charging light is on when Go Vac is in place.

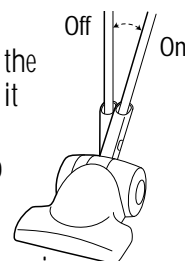

NOTE: For Model 3301, simply remove the Charging Plug from the port at the motor side of the Go Vac, and use as above.

Maintenance

The key to maximum performance is a clean Filter. Emptying the Filter after each use, and cleaning it periodically, will help your Go Vac operate at peak efficiency. Replacement Filters are available. See below.

To empty your filter:

1. With Go Vac facing away from you, grasp Dust Cup in right hand and turn it toward you (toward back of Go Vac).
2. Carry the Dust Cup, with filter in place, to a waste container. Remove Filter, shake debris from Filter and Dust Cup, then replace Filter in Dust Cup.
3. Replace Dust Cup by placing it in position and turning it away from you until it fits securely.
4. Clean exterior surfaces with a soft cloth dampened with water only. Do not use a strong detergent or other cleaner - this may damage the finish. Always remove the Go Vac from the Charging Base or unplug it from the wall outlet before cleaning the surface.
5. After heavy usage, you may clean the Filter by gently rinsing it in a bowl of water and mild dish detergent. Rinse thoroughly under running water and make certain it is completely dry before replacing it. You may also purchase replacement Filters.

Replacement Filters

Use only BISSELL Filters in your BISSELL Go Vac. If your Filter becomes damaged or becomes too dirty to wash, you may purchase new filters with the order form in this User's Guide, or by calling

BISSELL Consumer Services

1-800-237-7691

Monday - Friday 8 a.m. — 7 p.m. EST

Saturday 9 a.m. — 2 p.m. EST

Or visit our website @ www.bissell.com

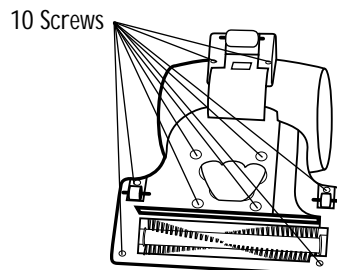

WARNING:
Never operate your Go Vac without the Filter in place. Doing so may damage the motor and void the warranty.

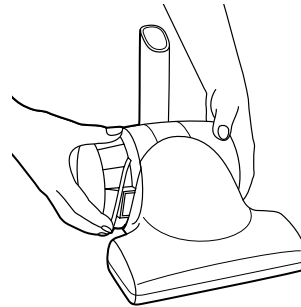

Battery Removal and Disposal

- WARNING:** This product contains a rechargeable nickel cadmium battery (sometimes referred to as a "Ni-Cad" battery) pack. According to Federal and State regulations, proper removal and disposal of Ni-Cad batteries is required. For removal of the battery pack in your Go Vac, see instructions below:
1. **IMPORTANT:** Unplug charger.
 2. Remove screws (10) holding Product Housing together (see diagram).
 3. Separate Housings and locate Battery Pack in bottom/center of unit.
 4. Remove wire connectors from the Battery Pack.
 5. Keep Battery Pack together - **DO NOT** separate individual batteries. For specific disposal instructions of batteries, please contact: RBRC (Rechargeable Battery Recycling Corporation) 1-800-822-8837.
 6. Discard remainder of product.

Troubleshooting

 **WARNING:** To reduce the risk of fire, electric shock or injury, unplug appliance from outlet before servicing.

Reduced suction/no suction.

Possible Causes	Remedies
Filter is full	Empty debris from Filter Clean Filter

Not powered/underpowered.

Possible Causes	Remedies
Go Vac not charged thoroughly	Check for red light on Go Vac when it is in Charging Base Is Go Vac correctly seated in Charging Base? Is cord completely connected at wall outlet?

Will not charge.

Possible Causes	Remedies
Go Vac not charged	Check for red light on Go Vac when it is in Charging Base Is Go Vac correctly seated in Charging Base? Is cord completely connected at wall outlet?

If suggested solutions for this or any function of the Cleaner do not correct the problem, call:

BISSELL Consumer Services

1-800-237-7691

Monday - Friday 8 a.m. — 7 p.m. EST

Saturday 9 a.m. — 2 p.m. EST

Or visit our website @ www.bissell.com

Replacement parts

Item	Part No.	Part Name
1	603-3540	Filter (2 pack)
2	603-0420	Charging Base Model 3300 Series - White*
3	603-0421	Charging Base Model 3300 Series - Blue*
4	603-0422	Charging Base Model 3300 Series - Purple*
5	603-0430	Charging Base Model 3302 Series*
6	603-0010	DC Adapter (Model 3301 only)
7	603-4480	Metal Extension Handle (4 sections)
8	603-4481	Handle Grip (White only)
9	603-0660	Dust Cup



1

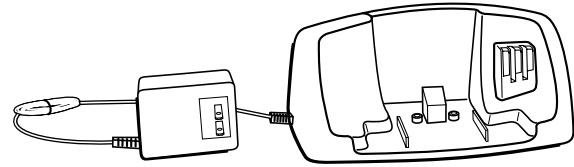

2, 3, 4, 5

* Charging bases are not interchangeable.

Note: To order replacement parts using your VISA® or MasterCard®, call:

BISSELL Consumer Services

1-800-237-7691

Monday - Friday 8 a.m. — 7 p.m. EST

Saturday 9 a.m. — 2 p.m. EST

Or visit our website @ www.bissell.com

Please have your model and part numbers of unit ready.

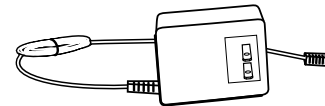

6

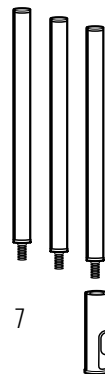

7



8

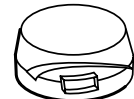

9

About your warranty

This warranty gives you specific legal rights, and you may also have other rights which may vary from state to state. If you need additional instruction regarding this warranty or have questions regarding what it may cover, call BISSELL Consumer Services.

One Year Warranty

BISSELL Inc., upon receipt of the product, will repair or replace, free of charge, any part which is defective or malfunctioning within one year of purchase to the original purchaser, provided the product is used for personal, and not commercial or rental service.

Damages or malfunctions caused by negligence, abuse, or use not in accordance with the User's Guide will not be covered. This warranty does not cover parts of the unit that require replacement under normal use.

Under this warranty, if it is BISSELL's conclusion that your unit cannot be repaired, BISSELL will replace the product.

If your BISSELL product should require service:

Call BISSELL Consumer Services at 1-800-237-7691 and we will give you the name and address of an authorized BISSELL Service Center in your area. If there is not an authorized BISSELL Service Center in your area, one of our Service Representatives will be happy to assist you. You can also visit the BISSELL website - www.bissell.com to locate a Service Center near you.

BISSELL Consumer Services

For information about repairs or replacement parts, or questions about your warranty, call:

BISSELL Consumer Services
1-800-237-7691

Monday - Friday 8 a.m. — 7 p.m. EST

Saturday 9 a.m. — 2 p.m. EST

Or write:

BISSELL INC
PO Box 3606
Grand Rapids MI 49501
ATTN: Consumer Services

When contacting BISSELL, have model number of unit available.

Please record your Model Number: _____

Please record your Purchase Date: _____

NOTE: Please keep your original sales receipt. It is your warranty.

It is suggested you staple your original sales receipt to the front of this guide.



©2000 BISSELL Inc
Grand Rapids, Michigan
All rights reserved. Printed in China.
Part Number 603-5890

Visit our website at:
www.bissell.com

Rev 5/00