

This Owner's Manual is provided and hosted by [Appliance Factory Parts](#).



Brisa BW5001 Owner's Manual

[Shop genuine replacement parts for Brisa BW5001](#)



[Find Your Brisa Evaporative Cooler Parts - Select From 32 Models](#)

----- Manual continues below -----



OWNER'S GUIDE

USE AND CARE MANUAL

WINDOW COOLER MODELS

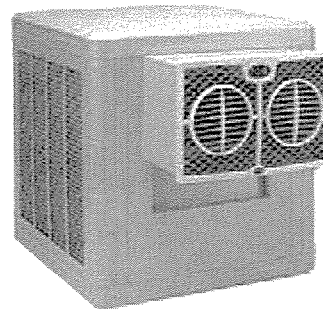

BW3500A / BW3500AMX

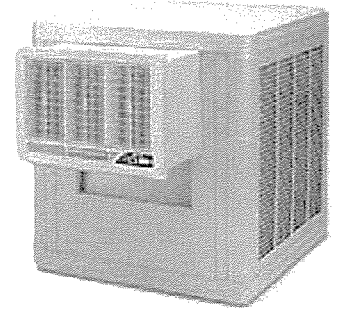

**BW4001 / BW4001MX
BW4501 / BW4501MX
BW5001 / BW5001MX**

For Customer Assistance

CALL 1-800-325-6952

DO NOT RETURN TO PLACE OF PURCHASE!

- | | |
|----------------|-------------------|
| * Safety | * Operation |
| * Installation | * Maintenance |
| * Start-up | * Troubleshooting |

Congratulations: You have purchased a product of superior performance and design, which will give the best service when properly installed, operated and maintained.

This guide will provide you with information needed to mount, operate, inspect, maintain, and troubleshoot your Brisa window evaporative air cooler.

The first section, Installation and Start-Up, gives details for installation. The second section, Maintenance, contains operational and maintenance instructions, while Troubleshooting includes information on commonly encountered problems.

INSTALLER: Please deliver this guide to owner.

WARNING - TO REDUCE THE RISK OF FIRE, ELECTRIC SHOCK, OR INJURY TO PERSONS, OBSERVE THE FOLLOWING.

READ AND SAVE THESE IMPORTANT SAFETY INSTRUCTIONS

- Read all instructions carefully before installation.
- This cooler must be connected to 120 volt AC, 60 Hz (cycle) power only. **NOTE:** Improper voltage will void the pump and/or motor warranties and may cause serious personal injury or property damage.
- This cooler must be plugged into a GFCI protected receptacle, which has been properly installed in accordance with all local and national codes. If you are not sure that the receptacle is GFCI protected, consult with a qualified electrician.
- This cooler is equipped with a power cord having an equipment grounding conductor and grounding plug. Do not attempt to defeat this safety device by removing the grounding pin.
- Use of an extension cord is not recommended.
- Do not operate if plug or cord is damaged in any way. If the unit is damaged or malfunctions, do not continue to operate it.
- Always disconnect electrical power to unit before attempting to work on or service your cooler.
- Some models may have a restricting orifice in the pump water tube to assure proper water flow rate to the pad. **Do not remove this restrictor!**

- Remove the plug from the electrical receptacle by pulling on the plug and not the cord.
- Do not operate this blower (fan) motor with any solid-state speed control device.
- Do not remove pad frames while cooler is running, this may cause the blower (fan) motor to overload and damage the motor windings.

NOTE:

- Do not locate unit near exhaust or vent pipes as odors or fumes may be drawn into cooler.
- Use of anode devices, chemical additives or treatments in this cooler will void the warranty.
- Your warranty does not cover shipping damage. Report all shipping damage at once to dealer or carrier making the delivery.
- For future reference, record the model and serial numbers, date and place of purchase of your evaporative cooler here:

Model # _____

Serial # _____

Date of Purchase: _____

Place of Purchase: _____

INTRODUCTION

Your Brisa evaporative air cooler was thoroughly tested and inspected before leaving the factory. This manual is your guide to proper installation procedures along with information about reasonable care and maintenance that will ensure safe, economical and trouble free cooling. Failure to follow these instructions may damage your cooler, impair its operation, create the potential for serious personal injury and/or void the warranty.

Read it carefully.

A Note About Air Exhausting / Maximum Cooling

Since coolers function best when there are plenty of openings for the air to exhaust, you can leave doors or windows open so your house can breathe. To get the maximum capacity of your cooler, and to help keep insects, dust, dirt, etc out of the cooled space, the house should be maintained at a slightly positive air pressure (that is, there should be slightly more air going into the house than is leaving). This is controlled by how much the windows or doors are opened.

How much should you open your windows or doors? You should adjust your openings until the air pressure inside the house is nearly balanced with the air outside. A good method to determine when the air is reasonably balanced is to place a tissue paper against the screen in the window or door farthest from the cooler and adjust the other openings in the house until the tissue paper stays lightly on the screen. You can adjust different windows in the house to direct the most airflow to the areas that are occupied during different times of the day or night (example: living room windows during the daytime, bedroom windows at night.)

HINT: To avoid a rush of warm air when starting the cooler, be sure to turn on the pump for a few minutes to completely wet out the pads before starting the blower.

INSTALLATION

Carefully read the contents of this manual and review the drawings of the cooler to familiarize yourself with the various parts before beginning the installation process.

CAUTION: Disconnect all electrical power to the cooler before attempting to install, open, or service your cooler.

Even while routinely inspecting or servicing the inside, the cooler can be accidentally started. Keep people and pets away from the cooler and electrical supply when you are working on it. Before opening, servicing or cleaning the unit, unplug the unit from the wall receptacle and take steps to ensure that the cord cannot be plugged back in and the cooler turned on accidentally. Do not plug power cord into the wall receptacle until installation or service work is complete.

Before attempting to install the cooler, confirm that the following preparations have been made:

- This cooler must be plugged into a 120 volt GFCI (Ground Fault Circuit Interrupter) protected receptacle. If you are not sure that the receptacle is GFCI protected, consult with a qualified electrician. This receptacle should be located within 5 feet of the window opening (cooler power cord is 6 feet long, use of extension cords is not recommended).
- Install cooler in a window where only fresh outside air can enter. Avoid installing the cooler in an area where the free air movement around and into the cooler is restricted or locations where obnoxious odors or fumes may be drawn into cooler from vent pipes, kitchen exhausts, etc.
- Verify that the supporting surface is strong enough to bear the weight of the cooler when in use. This unit will weigh approximately 250 pounds when operating at full capacity.
- Verify that the supporting surface is level in all directions.

Platform or stand mounting

Installation normally involves locating the unit in a suitable window and the construction of a platform or stand to support the weight of the cooler. Since every installation is different, the exact requirements to mount and seal a cooler against the weather will be best determined by the location and at the time of the installation. Most installations will require blocking of the unused portion of the window around the duct, or other modifications to the window frame may be necessary. See illustration (Fig. 1) for a typical installation. Construct a platform or stand below the window, strong enough to support the weight of the cooler (approximately 250 pounds).

- Measure and construct a level platform or stand that will allow the bottom surface of the cooler duct to rest on the window sill. Allow clearance for the drain/overflow standpipe connection.
- Position the cooler so that the duct rests on the window sill and the grille flanges are inside the window frame. **DO NOT drive nails or screws through bottom pan into mounting surface, this will void the warranty.**
- Lower the window to rest on the top of the duct (vertically hung windows) or slide window closed against side of duct (horizontal slider windows). Block any remaining unused portion of the window opening with a suitable blocking material (Plexiglas, solid plastic sheet, solid wood panel, etc.). It will be necessary to seal any joints around the duct to prevent entry of rain, dust/dirt, insects, etc. Any good quality caulking or foam tape will work.

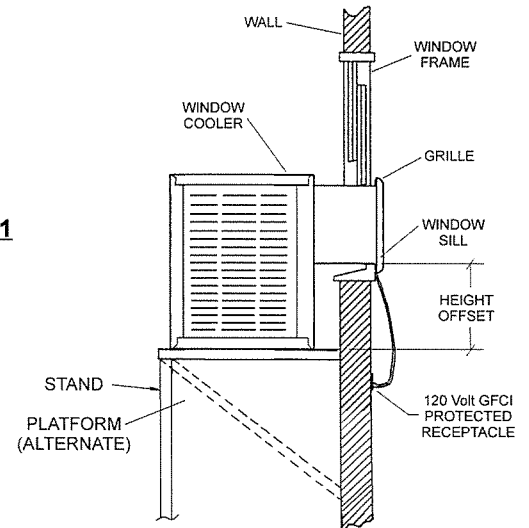

Figure 1

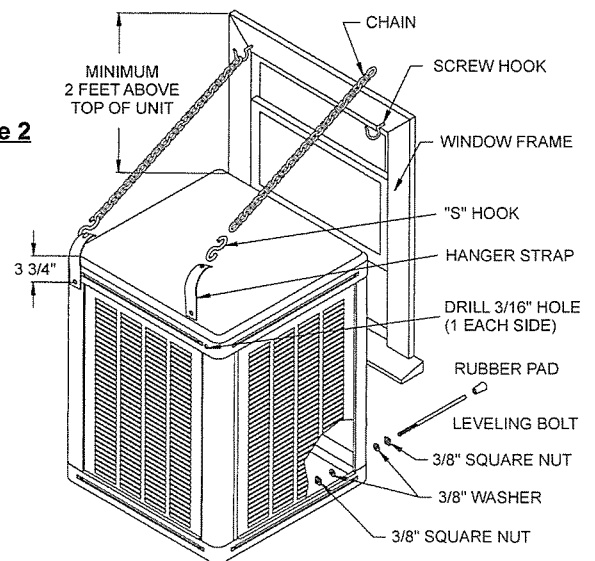

Figure 2

Mounting using chain kit

An alternate installation method involves locating the unit in a suitable window and using the included chain mounting kit to support the weight of the cooler. As with platform or stand mounting, every installation will be different. The exact requirements to mount and seal a cooler against the weather will be best determined by the location and at the time of the installation. Most installations will require blocking of the unused portion of the window around the duct, or other modifications to the window frame may be necessary. See illustration (Fig. 2) for a typical installation. Remember, the framing around the window must be strong enough to support the weight of the cooler (approximately 250 pounds).

Chain Kit contains:

2 - Screw Hooks	2 - "S" Hooks
2 - Leg Leveling Bolts	2 - Rubber Pads
4 - 3/8" Square Nuts	4 - 3/8" Washers
2 - Hanger Straps	2 - #10-24 x 1/2" long Bolts
2 - #10-24 Nuts	2 - 5' long Chain

Install chain kit as follows:

- Attach screw hooks to outside window frame approximately two feet above top of cooler. Be sure hooks are inserted to full depth in window framing for maximum strength.
- Attach chain to each hook.
- Attach hanging straps to top of rear corner support legs in the 3/16" diameter holes using the #10-24 bolts and nuts provided. Install "S" hooks in straps.
- Place leg leveling bolts thru 7/16" diameter holes in bottom of front corner support legs. Use nut and washer on outside of cabinet and install rubber pads on outside ends of leveling bolts. Place second nut and washer on leveling bolts inside cabinet.
- Position the cooler so that the duct rests on the window sill and the grille flanges are inside the window frame, allowing the "Z" shaped bracket, located under the grille, to rest on the window sill and butt against inside of window sill flange. Connect "S" hooks and screw hooks to chain links that bring the cooler closest to a level position.
- Use leg leveling bolts to brace the cooler away from the wall. Adjust bolts and chain to level cooler. NOTE: Cooler may need to be re-leveled to compensate for the added weight of water. Tighten nuts on leveling bolts inside cabinet.
- Lower the window to rest on the top of the duct (vertically hung windows) or slide window closed against side of duct (horizontal slider windows). Block any remaining unused portion of the window opening with a suitable blocking material (Plexiglas, solid plastic sheet, solid wood panel, etc.). It will be necessary to seal any joints around the duct to prevent entry of rain, dust/dirt, insects, etc. Any good quality caulking or foam tape will work.

Belt Tension Adjustment

CAUTION: Disconnect all electrical power to the cooler and insure that belt is not rotating before adjusting belt tension.

Correct belt tension and alignment is important, proper setup reduces power consumption and prolongs life of belt and motor. Check belt tension by squeezing belt. Proper tension will allow deflection of 1/2 to 3/4 inch. To increase or decrease belt tension, loosen bolt in slot of motor support bracket. Adjust belt to proper tension and retighten bolt.

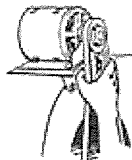

CAUTION: Never operate unit with pad frames removed. This will result in an overloaded condition and may damage the blower motor.

Install Overflow Standpipe / Drain Line

Install overflow drain bushing in bottom of cooler as follows:

- Slide rubber washer over drain bushing.
- Push drain bushing through bottom of cooler, assemble and tighten lock nut.
- Screw plastic overflow standpipe into the drain bushing and tighten snugly (hand tight) to prevent leakage.
- Connect a suitable drain line (copper / PVC / garden hose) to drain bushing. Never drain water onto a roof; mineral build-up or damage to roof may occur.

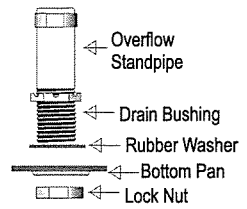

NOTE: Drain water in accordance with local plumbing codes.

Install Bleed-off

To minimize mineral scale "build-up" use the included bleed-off assembly. Remove the cap from the bleed-off tee; insert the black tubing and route the tubing through standpipe opening into the drain line. To prevent siphoning of the water, make sure that the bleed-off tee is above the water level.

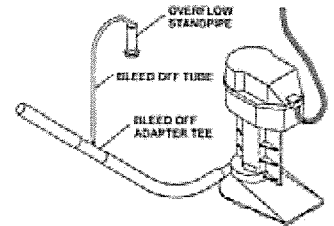

Connect Water Supply

CAUTION: All plumbing installations must comply with local building and safety codes, and must be performed by qualified personnel only.

NOTE: Coolers should not be connected to "soft" water systems. Soft water will accelerate corrosion and decrease the effective life of pads and cooler cabinet. Connect water line as follows:

- A water supply valve should be installed at a convenient location, to allow the water supply to be turned on and off for servicing or winterizing. Minimum 1/4" diameter tubing should be used to provide water to the cooler, larger tubing is recommended if the distance from the valve to the cooler is greater than 100 feet, then reduced to 1/4" at the unit.
- Install float valve in the bracket provided.
- Connect tubing from water supply to float valve. Place compression nut and ferrule over end of tubing, insert tube into float valve then tighten compression nut to secure.

Figure 3

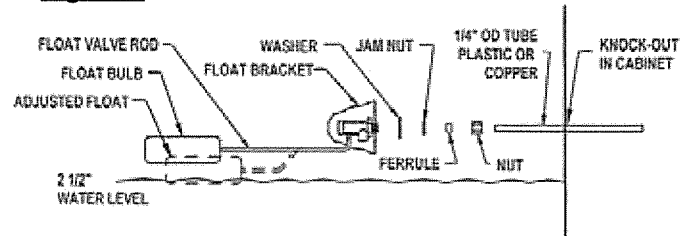

OPERATION

Controls

The rocker control switches are used to select the operating mode of the cooler. These switches control fan speed (High/Off/Low) and the cooling (pump) operation (On/Off).

GENERAL INSPECTION

Initial Start-up or Annual Inspection

CAUTION: Disconnect all electrical power to the cooler before attempting to install, open, or service your cooler.

Before start-up the cooler for the first time, or at the beginning of each cooling season, make sure that all required connections, adjustments, etc. have been made. Verify that:

- ✓ Cooler mounting is level; window and duct are sealed.
- ✓ Power supply cord is correctly routed, safe and secure.
- ✓ Motor, pump, drain, bleed-off, float valve, etc. are correctly installed and fully functional.
- ✓ Water line securely connected, turned on, no leaks noted.
- ✓ Float adjusted for proper water level.
- ✓ Pump impeller turns free and smooth. If in doubt, remove impeller cover (see "Cleaning Pump") and check rotation.
- ✓ Blower wheel, shaft, pulley and motor sheave bolts / setscrews are tight.
- ✓ Motor sheave / Blower pulley alignment okay; belt correctly tensioned, blower wheel turns freely.

Start-up Check List

CAUTION: Never operate cooler with pad frames removed. This will result in an overloaded condition and may damage the blower motor.

To verify and check out the cooler installation on initial or annual start-up, the following procedure should be followed.

- ✓ Open building exhaust / relief vents (windows, doors, etc.)
- ✓ Plug supply cord into wall receptacle. Switch cooler "ON".
- ✓ Verify that pump starts and pads are evenly wet.
- ✓ Observe that motor starts and runs.

In case of trouble on any of these steps, refer to the Troubleshooting Chart on page 6.

Cabinet Inspection Checklist

After initial start-up and for a few weeks afterwards, check for and/or observe the following: Refer to the Troubleshooting Chart on page 6 if necessary.

- ✓ Leaks from water lines, pad frames, cabinet, etc.
- ✓ Cooler pads: even wetting, no dry streaks.
- ✓ Confirm water level depth setting is correct.
- ✓ Verify full, even flow in water distribution system.
- ✓ Blower wheel / motor rotates freely, no unusual noises.
- ✓ Belt condition / tension / alignment OK.
- ✓ Check motor mounting, cabinet hardware, setscrews on pulleys, blower wheel are tight

MAINTENANCE SCHEDULE

Regular maintenance and periodic inspection is the key to long and successful service from your Brisa cooler. The cooler should receive major servicing at least once a year, more often if conditions require (dusty environment, constant use, poor water quality, etc.) For maximum cooling efficiency, long life and appearance, every two months during operation, the cooler should be inspected and cleaned.

NOTE: Do Not Undercoat the Water Reservoir

Your cooler's water reservoir is finished with our Peblar XT® appliance-type finish. It is so hard that asphalt-type cooler water pan under-coatings will not stick to it. Undercoating will break free, logging the pump and water distribution system.

NOTE: Do not use cooler cleaners, cooler treatments, anodes or other chemical additives in this evaporative cooler. Use of any additives or water treatment other than the furnished bleed-off will void your warranty and may impair the life of the cooler.

Before starting any maintenance operation, thoroughly read all operating and maintenance instructions and observe all cautions and warnings.

Cleaning

CAUTION: Never wash your cooler cabinet with a garden hose; water may harm motor and pump or seep into ductwork. Motors damaged by water are NOT covered under warranty.

All foreign materials, mineral scale, hard water deposits, dirt, etc. should be removed from pad frames, water pan and other components. Your cooler's long lasting finish can be brought to like-new condition by using warm water and a soft cloth.

NOTE: Avoid using scouring pads, steel wool or wire brushes, as these will damage the finish and encourage corrosion.

Maintenance & Inspection

IMPORTANT: Before operating cooler at the beginning of each cooling season, turn blower wheel, cooler motor and pump motor shafts by hand to make sure they turn freely. Failure to do so may result in burning out motor.

Periodic inspection of your cooler will enhance the chance for long, trouble-free service life. For maximum efficiency, every two months during operation, or any time the cooler is opened, the cooler should be inspected. Some suggested items to look for:

- ✓ Check for leaks from pad frames, cabinet, etc.
- ✓ Any dry spots or streaks on pads when pump is operating?
- ✓ Are bolts, nuts and set screws still snug?
- ✓ Are the bearings, etc., making any unusual noises?
- ✓ Does the blower wheel turn freely?
- ✓ Is float level set correctly?
- ✓ Is water in the bottom pan clean?
- ✓ Belt condition / tension / alignment OK?

Adjust Belt Tension

Each time you inspect your cooler, be sure to check belt tension on motor and blower assembly. Check belt condition and replace it if frays or cracks appear. Check alignment of blower pulley with motor pulley (see page 3 for detailed steps).

Cleaning Water Pump & Hose

CAUTION: Disconnect all electrical power to the cooler before attempting to install, open, or service your cooler.

CAUTION: Do not allow pump to fall over and become submerged; water will damage pump motor.

Clean water pump and hose assembly as follows:

- Unplug pump cord, remove mounting bracket screw and remove pump from cooler. Shake gently to remove water.
- To prevent breakage, carefully release the snap-out impeller cover plate and remove cover plate from the pump body.
- Using a mild detergent solution and a soft cloth, clean deposits from screen, around impeller and cover plate. Spin impeller to dislodge any remaining foreign material.
- Remove any foreign material in the hose adapter (between the pump and hose), or between the hose and the water distributor assembly.
- Rinse and reinstall impeller cover plate.
- Reinstall pump and reconnect pump cord.

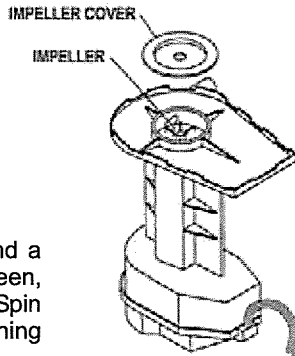

Draining

Drain the cooler for cleaning or at the end of the season as follows:

- Unplug cooler power supply cord from wall receptacle.
- Turn off water supply and remove pad frames.
- Connect a drain hose to the drain fitting on the bottom of the reservoir, if not already connected to drain line.
- Remove overflow standpipe from the drain fitting.
- Drain and clean reservoir. Remove any remaining water with a rag or sponge.

Touch-Up

The hardness, adhesion and smoothness of the internal and external finish on your cooler makes it extremely unlikely that scratches or chipping will occur. In the event that finish damage does occur, it should be promptly repaired by the following procedures:

1. Sand the area around bare metal spots.
2. Prime and paint with a quality paint.

Do not use asphalt type cooler undercoat material in water reservoir. Undercoat will break free, clogging the pump and water distributor.

Lubrication

Motor Bearings

The motors used in Brisa coolers have ports for lubricating the motor and are oiled at the factory. If the need for oiling is indicated, see individual motor nameplate for specific instructions on re-lubricating the motor. Under normal use, these motors require oiling about every 12 months of operation. **Do Not Over-Oil.**

Blower Shaft Bearings

Blower shaft bearings need periodic lubrication. They should be checked 20-30 days after initial start-up of operation. The oil cups on the bearings should be filled with a good grade of SAE 20W or 30W non-detergent oil when necessary. Under normal use, oiling is required every three months of operation. **Do Not Over-Oil.**

Pump Motor Bearings

The pump motor does not require lubrication.

Changing Cooler Pads

CAUTION: Disconnect all electrical power to the cooler before attempting to install, open, or service your cooler.

Your cooler pads should be changed at least twice a year... at the beginning of and midway through a season. However, your pads may need to be changed more frequently, depending on local air and water conditions. For instance, in areas where mineral content of the water is high, deposits may build up in the cooler pads, restricting airflow.

Replace pads as follows:

- Remove pad assembly from cabinet.
- Remove pad retainers from frame, using caution as retainers can spring back. Carefully remove all aspen from retainers. Remove and discard old pads.
- Using a mild detergent, wash dirt and scale from pad frames and rinse with fresh water. Wire brushing is not recommended. If finish is damaged or rusting is noted, repair area as noted in the "Touch-Up" section.
- Lay new pad in frame, starting at trough end, making sure pad is snug against trough and outer edges with no air spaces. Pad must completely fill frame (no gaps) or hot air may enter building.
- Pad thickness should be uniform across the frame.
- Replace pad retainers and lock under edge of frame. Sharp points must be buried into pad (they hold pad in place and prevent sagging).
- Pre-soak pads and check for air gaps along edges, reinstall pad frames into unit.

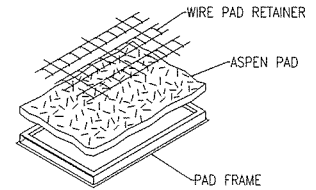

Winter Shut Down:

- Always drain all of the water out of the cooler and water supply line when not in use for prolonged periods, and particularly at the end of the season. Keep the water line disconnected from both the cooler and the water supply so it does not freeze.
- Disconnect power from cooler during extended periods of non-use.

REPLACEMENT PARTS

When ordering replacement parts, always refer to the serial and model number of your cooler. Use the part numbers listed in the accompanying parts list, as illustrated in the diagrams for your model.

TROUBLESHOOTING GUIDE:

Should an obvious problem occur with your cooler consult the following table. If you cannot correct the problem, or if it persists, contact qualified service personnel.

PROBLEM / SYMPTOM	POSSIBLE CAUSE	CORRECTIVE ACTION
Water draining from unit	Float valve out of adjustment	Adjust float to 2 1/2" water depth
	Float movement obstructed	Free float from obstruction
	Float valve non-functional	Replace float assembly
Dry pads	Pump intake clogged	Remove obstruction
	Water pump non-functional	Replace water pump
	Clogged water line	Locate and free obstruction
	Pad trough clogged	Clear debris from trough
	Switch non-functional	Replace switch
	Wiring non-functional	Repair or replace non-functional wiring
Motor does not start or no air delivery	Water turned off to cooler	Turn on water supply
	Electrical power disconnected	Check power receptacle and cord
	Belt too loose or too tight	Adjust belt tension
	Defective motor	Replace motor
	Defective switch	Replace switch
	Broken belt	Replace belt
Inadequate air delivery	Insufficient air exhaust	Open windows to increase air flow
	Belt too loose	Adjust belt tension or replace is needed
	Pads plugged	Replace pads
Motor cycles on & off	Low voltage	Check voltage
	Excessive belt tension	Adjust belt tension
	Blower shaft tight or locked	Oil or replace bearings
	Bearings dry	Oil bearings
	Non-functional motor	Replace motor
Noisy operation	Blower rubbing on housing	Reposition wheel
	Motor sheave or blower set screws loose	Tighten set screws
Excessive humidity in house	Inadequate exhaust	Open doors and windows to increase ventilation

WIRING DIAGRAM

