

1— 

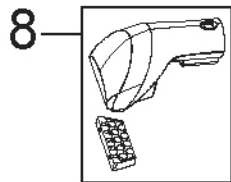

www.essco.net

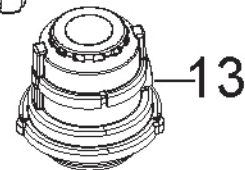
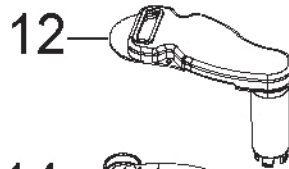
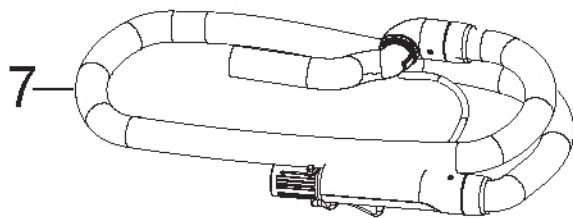
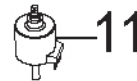
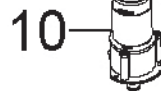
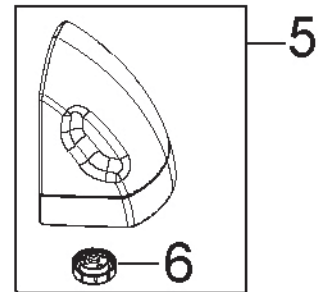
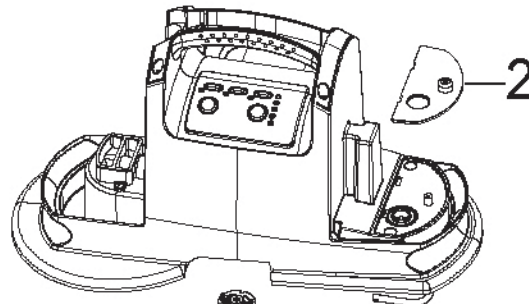
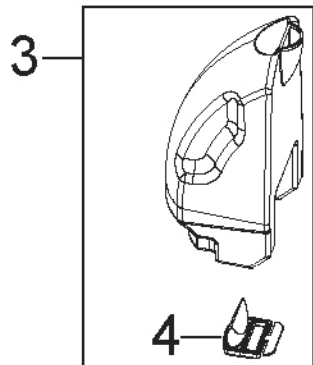
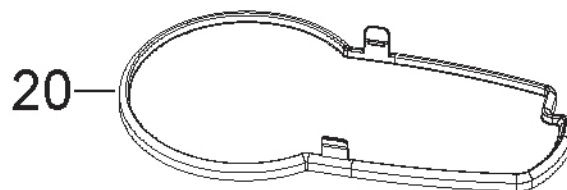
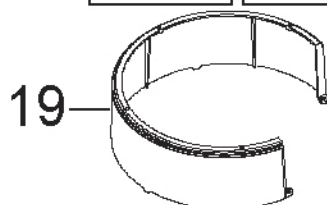
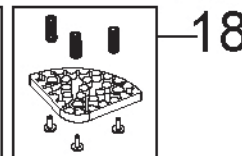
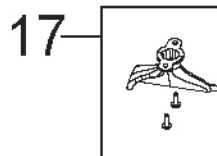
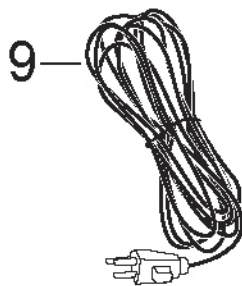
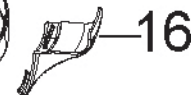
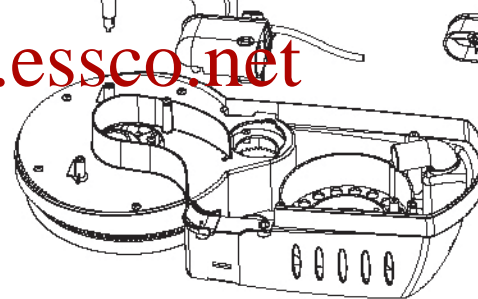

KEY	PART NO	DESCRIPTION
-----	---------	-------------

1	2036649	TANK LATCH W/ GASKET
2	2036663	TANK RECEIVER COVER
3	2036645	RECOVERY TANK
4	2036646	DUCKBILL VALVE
5	2036643	CLEAN TANK ASSY
6	2036644	CAP & INSERT ASSY
7	2036665	HOSE ASSY
8	2036651	3" TOOL
9	2036664	CORD
10	2036658	BRUSH MOTOR
11	2036659	PUMP
12	2036661	MANIFOLD DUCT
13	2036656	VACUUM MOTOR
14	2036662	TIRGGER VALVE
15	2036666	3" TOOL MOUNTING BRACKET
16	2036648	HOSE CLIP
17	2036667	SUCTION NOZZLE - 2pk W/SCREWS
18	2036669	BRUSH W/ SPRINGS & SCREWS
19	2036670	SPLASH GUARD
20	2036647	STORAGE TRAY
xx	2036770	USER'S GUIDE - CANADA
xx	2036650	USER'S GUIDE - UNITED STATES