

This Owner's Manual is provided and hosted by [Appliance Factory Parts](#).

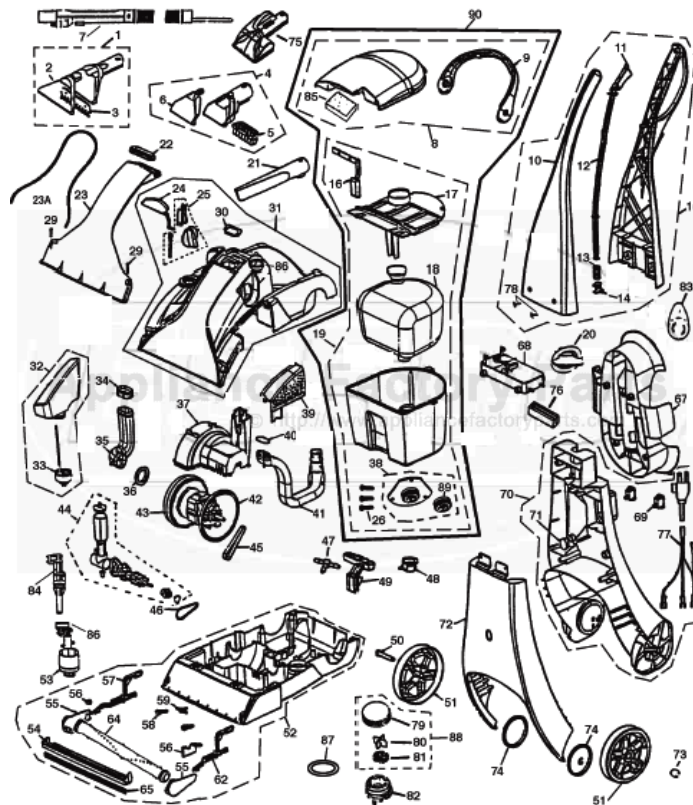

# Bissell 1698 Owner's Manual

[Shop genuine replacement parts for Bissell 1698](#)



[Find Your Bissell Vacuum Cleaner Parts - Select From 376 Models](#)

----- Manual continues below -----



# PowerWash ProHeat™

## USER'S GUIDE

1698 SERIES - 220 / 240V

3 Safety Instructions

4 Product View/Accessories

5 Assembly

6-15 Features / Operations

15-17 Routine Maintenance

18 Troubleshooting

19 Consumer Services

19 Replacement Parts

20 Warranty





*Thanks for buying a BISSELL PowerWash ProHeat™*

We're glad you purchased a BISSELL PowerWash ProHeat heated formula deep cleaner. Everything we know about floor care went into the design and construction of this complete, high-tech home cleaning system.

Your PowerWash ProHeat is well made, and we back it with a limited two-year warranty. We also stand behind it with a knowledgeable, dedicated Consumer Services department, so, should you ever have a problem, you'll receive fast, considerate assistance.

My great-grandfather invented the floor sweeper in 1876. Today, BISSELL is a global leader in the design, manufacture, and service of high quality homecare products like your PowerWash ProHeat.

Thanks again, from all of us at BISSELL.

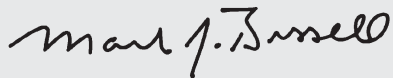

Mark J. Bissell  
President and Chief Executive Officer

# IMPORTANT SAFETY INSTRUCTIONS

When using an electrical appliance, basic precautions should be observed, including the following:

## READ ALL INSTRUCTIONS BEFORE USING YOUR UPRIGHT DEEP CLEANER.

Always connect to a properly Earthed Outlet. Unplug from outlet when not in use and before conducting maintenance or troubleshooting.

 **WARNING:** To reduce the risk of fire, electric shock, or injury:

- Use indoors only
- Do not immerse
- Use only on surfaces moistened by cleaning process
- Do not leave machine when it is plugged in
- Do not service machine when it is plugged in
- If the supply cord is damaged, it must be replaced by an authorized Service Center in order to avoid a hazard
- Do not use machine if it has been dropped, damaged, left outdoors or dropped into water
- Do not expose to rain, store indoors
- Do not pull or carry by cord, use cord as a handle, close door on cord, pull cord around sharp corners or edges, run appliance over cord, or expose cord to heated surfaces
- Do not carry the appliance while in use
- Do not unplug by pulling on cord. Unplug by grasping plug, not the cord
- Do not handle plug or appliance with wet hands
- Do not put any object into appliance openings, use with blocked opening, or restrict air flow
- Do not expose hair, loose clothing, fingers or body parts to openings or moving parts
- Do not pick up hot or burning objects
- Do not pick up flammable or combustible materials (lighter fluid, petrol, kerosene, etc.) or use in the presence of explosive liquids or vapour
- Do not use appliance in an enclosed space filled with vapours given off by oil base paint, paint thinner, some moth proofing substances, flammable dust, or other explosive or toxic vapours

- Do not pick up toxic material (chlorine bleach, ammonia, drain cleaner, petrol, etc.)
- Do not modify the 3-pin Earthed plug
- Do not allow to be used as a toy
- Do not use for any purpose other than described in this User's Guide
- Use only manufacturer's recommended attachments
- Use only cleaning products formulated by BISSELL for use in this appliance
- Keep openings free of dust, lint, hair, etc.
- Keep appliance on a level surface
- Turn off all controls before unplugging
- Be extra careful when cleaning stairs
- Pay close attention when working around children

## SAVE THESE INSTRUCTIONS.

THIS MODEL IS FOR HOUSEHOLD USE ONLY.

 **WARNING:** This appliance must be earthed.

**IMPORTANT** FOR OPERATION ON A 220/240 VOLT A.C. 50/60 Hz POWER SUPPLY ONLY.

If your appliance is fitted with a nonrewireable BS 1363 plug it must not be used unless a 13 amp (ASTA approved to BS 1362) fuse is fitted in the carrier contained in the plug. Spares may be obtained from your BISSELL supplier. If for any reason the plug is cut off, it must be disposed of, as it is an electric shock hazard should it be inserted into a 13 amp socket.

**Keep plenty of genuine BISSELL Advanced Deep Cleaning Formulas on hand so you can clean and protect whenever it fits your schedule. Always use genuine BISSELL Advanced Deep Cleaning formulas. Non-BISSELL cleaning solutions may harm the machine and void the warranty.**

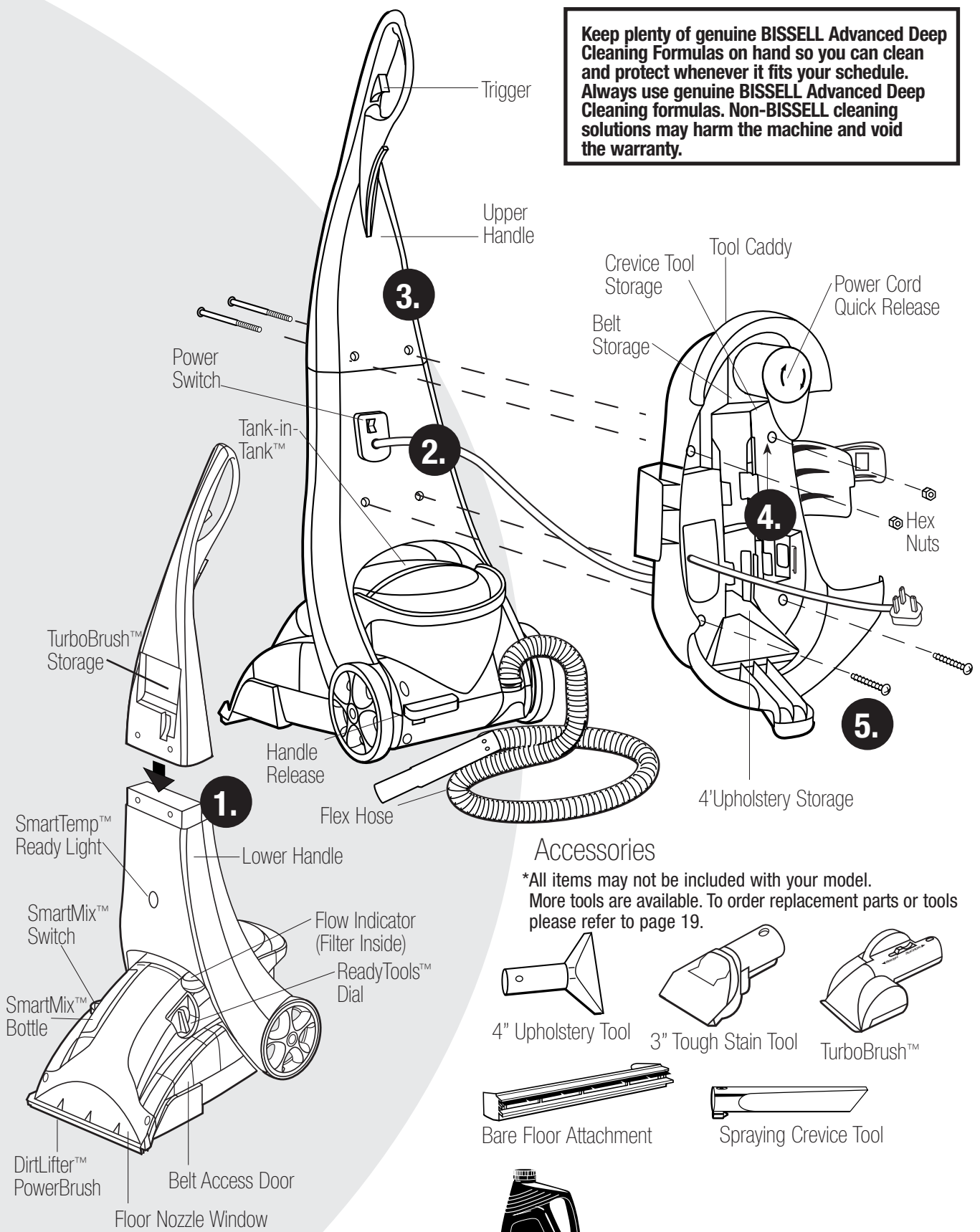

### Accessories

\*All items may not be included with your model. More tools are available. To order replacement parts or tools please refer to page 19.

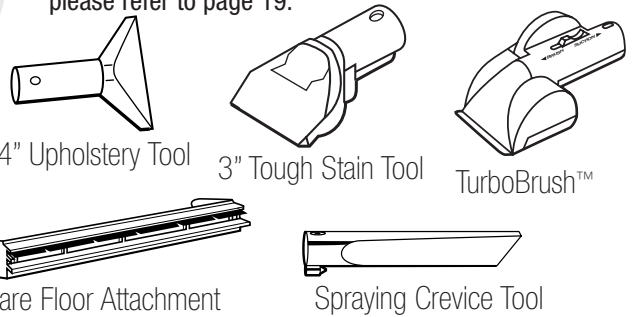

950 ml BISSELL  
Fibre Cleansing  
Formula™

## How To Use This Guide

This User's Guide has been designed to help you get the utmost satisfaction from your BISSELL PowerWash ProHeat. You'll find assembly and operating instructions, safety precautions, as well as maintenance and troubleshooting instructions. Please read this User's Guide thoroughly before assembling your deep cleaner.

Pay particular attention to the product diagram, assembly instructions, and part names. Locate and organize all parts before assembly. Familiarize yourself with the parts and where they go. Following this User's Guide will greatly enhance your ability to get the most performance from your BISSELL PowerWash ProHeat for many years.

Your PowerWash ProHeat comes in 3, easy to assemble components.

Upper Handle  
Lower Handle  
Tool Caddy

The only tool you will need to assemble your cleaner is a Phillips head  screwdriver.



### WARNING:

Do not plug in your cleaner until you have completely assembled it per the following instructions and are familiar with all instructions and operating procedures.

## How To Put It Together

### Refer to Assembly Diagram on page 4

1. Slide Upper Handle firmly onto Lower Handle until screw holes are completely aligned.
2. Feed bundled Power Cord through Tool Caddy from Caddy's flat side.
3. Align Upper Handle holes and Tool Caddy holes.
4. Place hex nut into back of Tool Caddy and hold in place. Insert bolt from front to back turning into the hex nut until snug. Do not over tighten. Repeat for the second bolt and hex nut.
5. Insert 2 screws into lower 2 holes. Turn until snug.
6. Snap tools into storage on the Tool Caddy as shown in figure 6.
7. Wrap Power Cord and Flex Hose as shown in figure 7.
8. Insert TurboBrush into storage on Upper Handle by tilting the top of the TurboBrush and snapping it into place.

**PowerWash ProHeat assembly is now complete.**

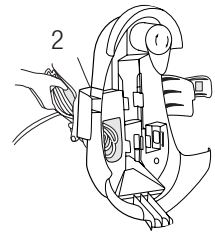

4



5

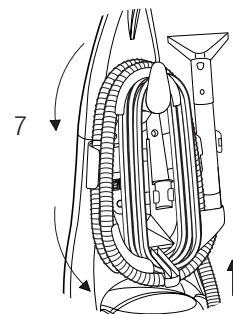
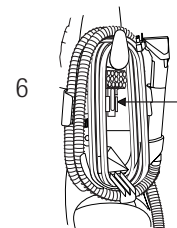

## Special Features of your BISSELL PowerWash ProHeat™

### The BISSELL SmartClean™ System

The PowerWash ProHeat is a home cleaning system that automatically mixes hand hot tap water with BISSELL Advanced Deep Cleaning Formula and heats the solution as it is applied to the carpet. The combination of heated cleaning solution, powered brush and suction provide a safe and effective method of cleaning.

### SmartTemp™

Temperature control automatically heats the cleaning solution as it is being applied to the carpet (\*) to safely optimize cleaning effectiveness.

- 1.** The Power Switch controls the power to the machine and the SmartTemp feature.  
**\*SmartTemp heats the cleaning solution for carpet and bare floor application only. It does not heat solution sprayed through the accessory tools.**
- 2.** The SmartTemp Ready Light indicates the heater is ON. It is found on the front of the handle where it is easy to see while you clean. Wait two minutes for the heater to warm up before beginning to clean.
- 3.** SmartTemp increases the water temperature approximately 25° and will not allow it to exceed 180°.

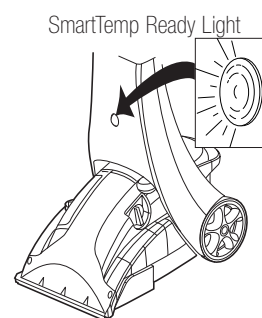
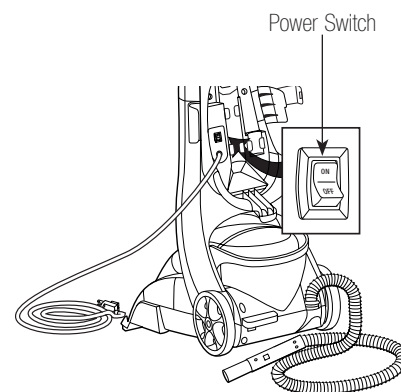

### SmartMix™

Provides custom control for each cleaning job.

- 1.** Lift the SmartMix Bottle up and out of the machine base.
- 2.** Turn the SmartMix Bottle over so that the Valve Cap is in an upward position. Unscrew the Valve Cap and fill the SmartMix Bottle to the mark with BISSELL Advanced Deep Cleaning Formula.
- 3.** Replace the Valve Cap, turning until snug.

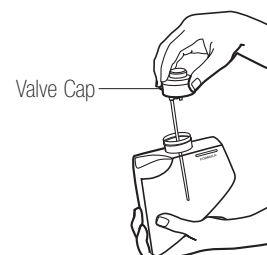
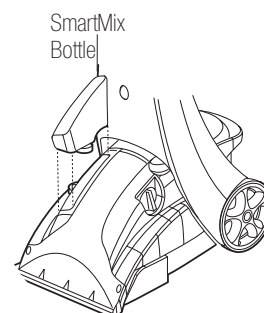

## SmartMix Continued

4.

Replace SmartMix Bottle.

5.

Choose the SmartMix setting that fits the cleaning job.

**Water Only**- use for gentle cleaning or for the final rinse after cleaning.

**Normal**- automatically provides the best mix of water and cleaning solution for most cleaning jobs.

**High Traffic**- automatically mixes the right amount of water and cleaning solution to dissolve tough grime and heavy soil. Note: Residual cleaning materials left in carpet from other products may cause excessive foaming when picked up. If foam is overflowing Tank, move SmartMix Dial to "**Water Only**" position until the condition stops.

**Note: Both the SmartMix Bottle and the clean water Tank must have liquid in them in order for the machine to spray. If one is empty, the machine will temporarily lose its prime and will not spray cleaning solution or water only.**

**Important: If you are using the WATER ONLY setting, fill the SmartMix Bottle with water also!**

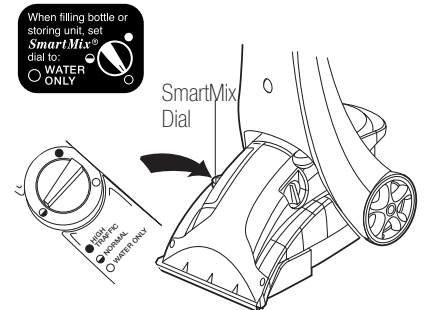

### Tip:

Deep cleaning stairs and high traffic areas on a regular basis can prolong carpet life.

## DirtLifter™ PowerBrush

The powered brush roll at the Floor Nozzle is designed to enhance cleaning performance. The bristle pattern lifts out the deep down dirt while gently grooming carpet fibres. The floating suspension self-adjusts to all carpet heights. When the machine handle is in the fully upright position, Carpet Saver™ automatically raises the brush off the carpet and protects your carpet if you leave the Power Switch ON.

### **!WARNING:**

To reduce the risk of fire, use only BISSELL Advanced Deep Cleaning Formulas for full size machines in your PowerWash ProHeat. Use of cleaning formulas which contain lemon or pine oil may damage this appliance and void the warranty. Chemical spot cleaners or solvent based soil removers should not be used. These products may react with the plastic materials used in your PowerWash ProHeat, causing cracking or pitting.

## Tank-in-Tank

Our Tank-in-Tank system is designed with a Bladder inside for clean water. As you clean, the Bladder will empty. Dirty water collects in the tank outside the Bladder.

1. Step on Handle Release to lay the machine handle down out of the way.
2. Lift the Tank-in-Tank handle. The handle locks the lid in place.
3. Carry it like a bucket to fill at the sink.
 

**Note: You may notice hair and debris deposits on the carpet that were loosened by the brushing action (especially with newer carpets that have never been deep cleaned before). This debris should be picked up and thrown away. Debris that deposits in the Brush Belt should be cleaned between uses to keep the Belts running free.**

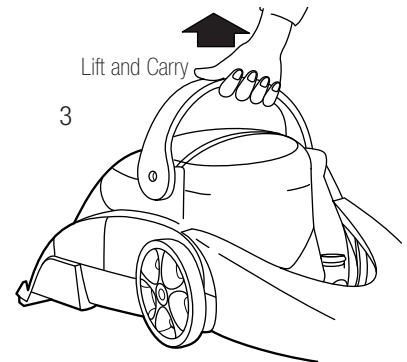
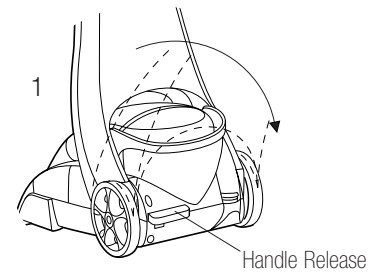

4. Set the Tank down and rotate the handle forward to unlatch the lid. Lift off and set the lid aside.

5. Find the mouth of the Bladder and fill to the bottom of the neck with clean hand hot tap water. **Do not boil or microwave water as it can destroy the Bladder.**

**Note: Fill the Bladder with clean hand hot tap water only.**

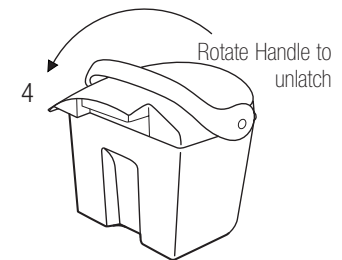

6. Replace the Tank Lid matching the lid and tank edges. Handle must be in the forward position to re-install.

7. Rotate the handle to the carrying position to re-latch the lid.

8. Replace Tank in machine base, seating firmly in place.

9. Rotate handle back down to the latched position.

**Note: Both the SmartMix Bottle and the clean water Tank must have liquid in them in order for the machine to spray. If one is empty, the machine will temporarily lose its prime and will not spray cleaning solution or water**

**Important: If you are using the WATER ONLY setting, fill the SmartMix Bottle with water also!**

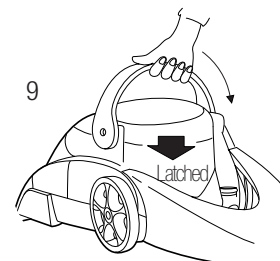
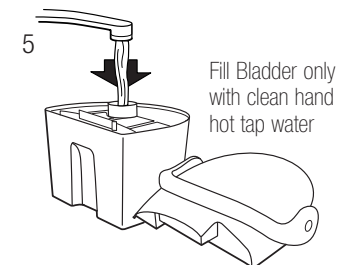

## When It's Time to Empty Tank-in-Tank

1. Remove the Tank-in-Tank – follow steps 1 and 2 above.
2. Carry the Tank-in-Tank, like a bucket, to the sink where you will dispose of the dirty water.

## When It's Time to Empty Tank-in-Tank Continued

3. Remove Tank Lid by rotating handle forward to unlatch lid and lifting lid off Tank.
4. Pour out dirty water.
5. After each use, remove and rinse the Lint Screen located on the tank lid.
  - A. Remove Tank Assembly from unit.
  - B. Remove Tank Lid.
  - C. Remove any debris caught in Lint Screen.
  - D. Re-insert Lint Screen on Tank Lid. The screen will click into place
  - E. Replace Tank Lid.
  - F. Re-insert Tank Assembly into unit.
6. Refill with clean hand hot tap water, following steps 5 through 9 on page 8, and refill the SmartMix Bottle with BISSELL Advanced Deep Cleaning Formula as necessary.
7. When the cleaning job is complete, rinse out the Tank-in-Tank by rinsing clean water between the Bladder and Tank.
8. Return Tank-in-Tank to the machine, following steps 6 through 9 on page 8.
9. Refer to the **Maintenance** section on pages 15-16 for the final cleanup.

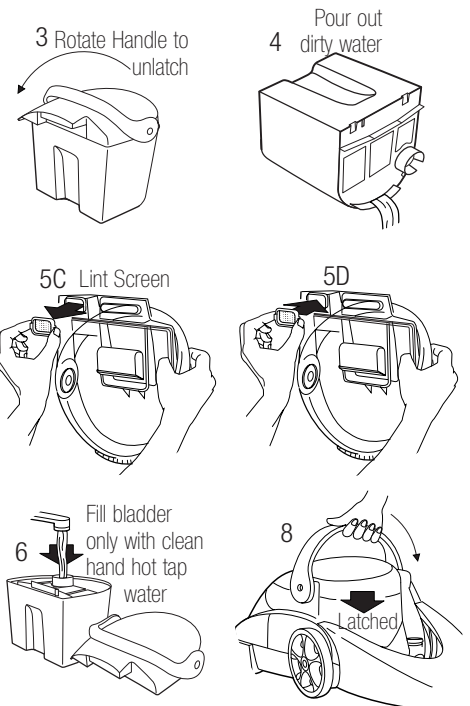

### Tip:

A special red float device in the Tank will cause the cleaner to stop removing solution from the carpet and the motor sound will rise in pitch to let you know the dirty water tank is full.

### Tip:

Thorough vacuuming before deep cleaning will prevent early clogging of Lint Screen.

## The Flow Indicator

The Flow Indicator is located on the machine base. It spins when the trigger is pressed to indicate that the machine is applying cleaning solution to the floor. It will stop spinning to indicate that the SmartMix Bottle or Bladder needs to be refilled, or when the trigger is released.

**Note: Flow Indicator does not spin when set to Tools/PreTreat setting.**

## ReadyTools Dial

This provides above floor cleaning with the flip of a switch. Just choose the cleaning tool attach to the Flex Hose and PowerWash ProHeat is ready to clean upholstery, stairs and more.\*

**\*Set the ReadyTools Dial to Floor Cleaning when cleaning carpets or bare floors or set it to Tools/PreTreat when using the Flex Hose attachments or for pre-treating floors.**

**SmartTemp heats the cleaning solution for carpet and bare floor application only. It does not heat solution sprayed through the accessory tools.**

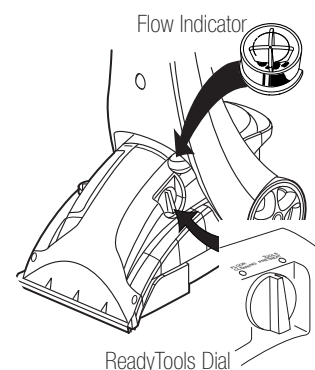

## TurboBrush™ Assembly and Use

Unplug cleaner from the outlet before attaching TurboBrush. Attach TurboBrush to the Flex Hose by pressing tool onto the grip/trigger until button snaps into hole. Make certain tool is securely in place.

1. Move the TurboBrush switch to the **"BRUSH"** position. This activates the brush when the unit is running.
2. Place the tool directly on the soiled surface. Apply downward pressure on the tool and pull towards you while pulling trigger to spray cleaning solution.
3. Release the spray trigger and move the switch to the **"SUCTION"** position. Vacuum the area until no more cleaning solution can be removed.
4. Repeat steps 1-3 until no more dirt can be removed. **Caution: Do not overwet.**

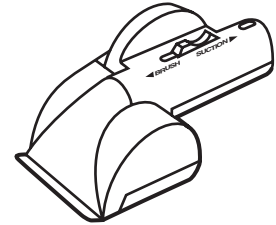
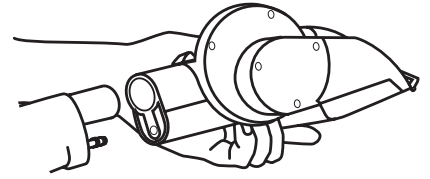

## When You're Done

1. Disconnect the TurboBrush from the Flex Hose by pushing down on the button lock and pulling straight off.
2. Once removed from the Flex Hose, the TurboBrush can be cleaned.
  - A) Move the switch to the **"SUCTION"** position
  - B) Rinse under running water.
  - C) Check spray nozzle for dirt. If necessary, clean with a soft bristle brush.
  - D) Replace TurboBrush in its special storage location on the handle front.

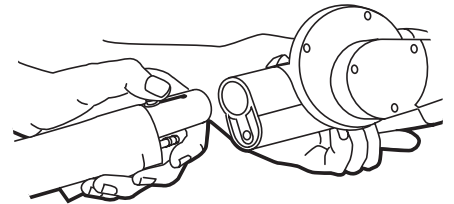

## Operations

### Before You Clean Carpets

1. Plan activities to give carpet time to dry.
2. Remove easily moved furniture from the room (chairs, lamps, coffee tables, etc).
3. Vacuum thoroughly to pick up loose debris and pet hair before using the PowerWash ProHeat.
4. Plan your cleaning route to leave an exit path. It is best to begin cleaning in the corner farthest from your exit.

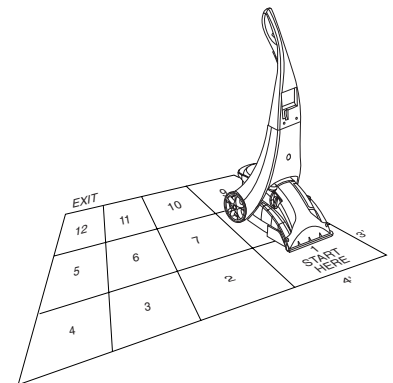

## Machine Preparation

1. Set up the machine following instructions in the **Features** section on pages 6-10.
2. Use any BISSELL Advanced Deep Cleaning Formula in the SmartMix Bottle when cleaning carpets, stairs or upholstery. Use clean water in the SmartMix Bottle for gentle cleaning or rinsing.
3. Choose the SmartMix setting to match the cleaning job.
4. Set the ReadyTools switch to either **Tools/PreTreat** or **Floor Cleaning**.

## PreTreating (Optional)

PreTreating is recommended to improve cleaning effectiveness for heavily soiled carpet in high traffic areas such as hallways and stairs.

1. Set the SmartMix Dial to **High Traffic**.
2. Set ReadyTools Dial to **PreTreat**.
3. Plug into a proper outlet and turn the Power Switch ON.
4. While pressing the trigger, slowly make several passes over the area to be cleaned.  
**Caution: Do not overwet.**
5. Turn the Power Switch OFF and let the BISSELL Advanced Deep Cleaning Formula dissolve the tough soil for 1-2 minutes before continuing.

## Carpet Cleaning

1. Plug into a proper outlet and turn the Power Switch ON. Wait two minutes for the heater to warm up before beginning to clean.
2. While pressing the trigger, make one slow forward wet pass and another one back. Let the SmartTemp heated formula and DirtLifter Powerbrush do the work for you.  
**Caution: Do not overwet.**  
**Note: Take care not to run over loose objects or edges of area rugs. Stalling the brush may result in premature belt failure.**
3. Release the trigger and make one slow forward and back pass over the same area to remove any residual dirty water.

### **WARNING:**

To reduce the risk of injury, be extra careful when cleaning stairs. Make sure machine is secure and level.

### **ATTENTION BERBER CARPET OWNERS:**

Some Berber Carpets have a tendency to fuzz with wear. Repeated strokes in the same area with an ordinary vacuum or deep cleaner may aggravate this condition. Please see Stain Removal instructions on pages 12-13.

## Carpet Cleaning Continued

**4.** Repeat cleaning passes until solution being pulled up appears clean.

**5.** Continue passes without pressing the trigger until you can't see any more water being pulled up.

**Note: Both the SmartMix Bottle and the clean water Tank must have liquid in them in order for the machine to spray. If one is empty, the machine will temporarily lose its prime and will not spray cleaning solution or water.**

**6.** After cleaning, you may want to turn the SmartMix Dial to the **Water Only** setting to give your carpeting a final rinse. This will ensure thorough removal of embedded dirt loosened by the BISSELL Advanced Deep Cleaning Formula. BISSELL Advanced Deep Cleaning Formulas contain an anti-resoiling agent that helps your carpets repel dirt and keeps them looking good longer.

**7.** When the cleaning job is complete refer to the **Maintenance** section on pages 15-16 for machine cleanup and storage instructions.

**Note: You may notice hair and debris deposits on the carpet that were loosened by the brushing action (especially with newer carpets that have never been deep cleaned before). This debris should be picked up and thrown away. Debris that deposits in the Brush Belt should be cleaned between uses to keep the Belts running free.**



## Stain Removal

**Do Not Delay!** Failure to attend to an accident soon after it occurs may cause it to set and become permanent.

Before treating any stain, follow these pretreatment steps:

**1.** Blot up liquids with an absorbent cloth or paper towels. White materials are recommended because certain dyes may bleed and make the stain worse.

**2.** Gently scrape up semi-solids with a spoon or spatula. Do not use a knife or other utensil with sharp edges because it could damage the carpet or upholstery.

**3.** If the area has dried, remove the remaining semi-solids and residue with a sweeper or vacuum.

**4.** Be sure to pre-test any spot removal solutions or chemicals on an inconspicuous area first. This is extremely important; different dyes and materials could be damaged or discolored by a cleaning solution. If such a change should occur, try a different solution or call a professional. If cleaning on Berber Carpet gently run your machine over a hidden area. If no fuzzing occurs, continue cleaning in soiled area.

## Stain Removal Continued

5. Use your BISSELL Deep Cleaner as a Precleaner. With one of the tools attached to the Flex Hose, set the ReadyTools Dial to **Tools/PreTreat** and the Smart Mix Dial to the **High Traffic** setting. Spray the area with cleaning solution and allow the BISSELL Advance Deep Cleaning Formula to penetrate for 3-5 minutes.
6. Once the Precleaning is complete, use the attached tool to gently scrub the stain with back and forth strokes.
7. Allow to dry. Some difficult stains may require a second treatment.

## How to Clean Upholstery and Small Areas

### Important - Check Upholstery Tags:

1. Check manufacturer's tag before cleaning. "W" or "WS" on the tag means you can use your PowerWash ProHeat. If the tag is coded with "X" or "S" (with a diagonal strike through), or says "Dry Clean Only," do not proceed. Do not use on velvet, silk, 100% cotton upholstery, vinyl or leather. If manufacturer's tag is missing or not coded, check with your furniture dealer.
2. Check for colourfastness in an inconspicuous place.
3. If possible, check upholstery stuffing. Coloured stuffing may bleed through fabric when wet.
4. Plan activities to give upholstery time to dry.
5. Vacuum thoroughly to pick up loose debris and pet hair. Use a vacuum with a brush attachment and a crevice tool to clean in fabric folds and tufts.

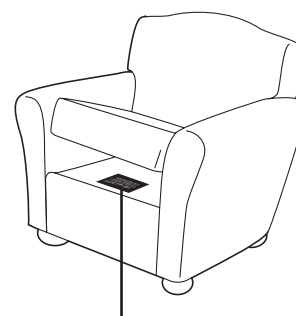

Manufacturer's tag

## Machine Preparation

1. Set up the machine following instructions in the **Features** section on pages 6-10.
2. Use any BISSELL Advanced Deep Cleaning Formula in the SmartMix Bottle.
3. Set the ReadyTools Dial to **Tools/PreTreat**.  
**Note: Tools Flow Indicator does not spin when set to Tool/Pretreat setting.**  
**\*SmartTemp heats the cleaning solution for carpet and bare floor application only. It does not heat solution sprayed through the accessory tools.**
4. Set SmartMix Dial to **Normal**.

## Cleaning Technique

1. Choose the 4" Small Area Tool, the 3" Tough Stain Tool, or the Spraying Crevice Tool and connect to the Flex Hose.
2. Plug into a proper outlet and turn Power Switch ON.
3. While pressing the trigger, slowly move the spraying tool back and forth over the soiled surface. Release the trigger to suction soiled water.
4. Continue to clean soiled area, working in small sections, until no more dirt can be removed.  
**Caution: Do not overwet.**
5. When the cleaning job is complete refer to the **Maintenance** section on pages 15-16 for machine cleanup and storage instructions.

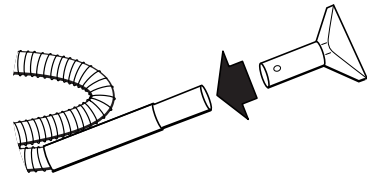

## Cleaning Bare Floors

The Bare Floor Tool provides effective cleaning for linoleum, vinyl, and tile floors.

**Caution: Do not use on hardwood floors.**

1. Use BISSELL Floor Cleansing Formula the in SmartMix Bottle.
2. Vacuum or sweep thoroughly to pick up loose debris and pet hair.
3. Remove easily moved furniture from the room (chairs, tables, etc).
4. Plan your cleaning route to leave an exit path.
5. Plan activities to allow 30 minutes for the floor to dry completely.

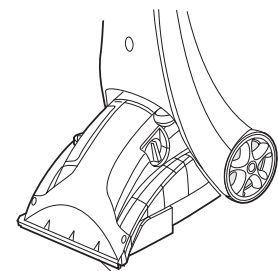
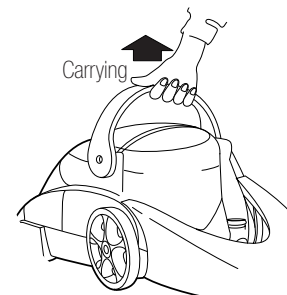
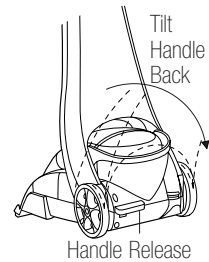

## Attach the Bare Floor Tool

1. Step on the Handle Release to lay the machine handle down.
2. Remove the Tank-in-Tank from the machine base.
3. Lift the machine base to expose the underside of the Floor Nozzle.
4. Attach Bare Floor Tool to the Floor Nozzle with long Tab to the right side (ReadyTools side) of the Floor Nozzle.

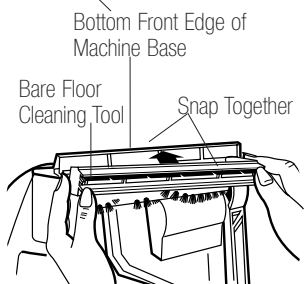

## Attach the Bare Floor Tool Continued

5. First attach left side (short Tab) catching Tab over Floor Nozzle edge.
6. Gently bend long Tab (right side) outward to easily snap over edge of clear nozzle on left.

## Machine Preparation

1. Set up machine following instructions in the **Features** section on pages 6-10. Be sure to thoroughly rinse out any remaining BISSELL Advanced Deep Cleaning Formula from the SmartMix Bottle to prevent slippery linoleum, vinyl, and tile floors. **Use BISSELL Floor Cleansing Formula in the SmartMix Bottle.**
2. Check ReadyTools Dial - it should be set on **Floor Cleaning**.
3. Choose the SmartMix setting to match the cleaning job.
4. Plug into a proper outlet and turn Power Switch ON. The SmartTemp Ready Light illuminates and the PowerWash ProHeat is ready to clean.



## Bare Floor Cleaning Technique

1. Slowly move the machine Nozzle with Bare Floor Tool forward and back over soiled surface one time while pressing the trigger. **Caution: Do not over wet.**
2. Repeat the motion without pressing the trigger using the Bare Floor Tool to squeegee and suction up the dirty water.
3. Repeat steps 1 and 2 backing along the exit path.
4. Allow about 30 minutes for the floor to dry completely.
5. When the cleaning job is complete refer to the **Maintenance** section on pages 15-16 for machine clean up and storage instructions.
6. To remove Bare Floor Tool, gently bend long Tab (right side) outward and pull tool down away, from the Floor Nozzle. Rinse thoroughly, dry and store



## Routine Maintenance

1. Turn Power Switch OFF.
2. Unplug Power Cord from the outlet and coil around Power Cord Quick Release.

### Tip:

SmartMix Bottle may be stored with cleaning solution for your next cleaning job. Make sure dial is turned to the Water Only setting when storing.

## Routine Maintenance Continued

3. Remove and rinse tools in clean, running water. Dry and replace on Tool Caddy.
4. Coil Flex Hose around storage brackets on Tool Caddy.
5. Remove Tank-In-Tank, dispose of dirty water. Refer to the **Features** section on Pages 8-9.
6. Rinse out Tank-In-Tank and replace on the machine; Clean out Lint Screen.
7. Clean out the Flow Indicator Filter each time it is used to ensure best cleaning performance. Unscrew the Flow Indicator Cap, lift out the Red Rotor and White Filter. Rinse all three parts in tap water. Replace the Filter and Rotor. Replace the Flow Indicator Cap; turn until snug, do not over-tighten.
8. Wipe all exterior surface with a soft cloth.
9. Store cleaner upright in a protected, dry area.  
**Note: PowerWash ProHeat uses water and must not be stored where there is a danger of freezing. Freezing will damage internal components and void the warranty.**
10. When carpet is dry, vacuum again to remove hair and fuzz that the PowerWash ProHeat may have loosened.

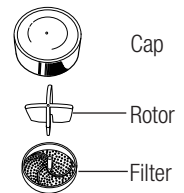
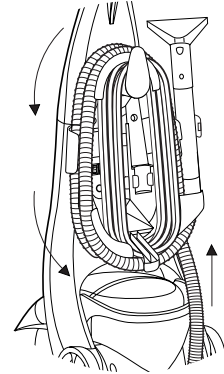

## Pump Belt Replacement

1. Turn the Power Switch OFF and unplug from the outlet.
2. Step on the Handle Release and recline the handle down onto floor (see illustration).
3. Remove Tank-In-Tank and SmartMix Bottle. Set them aside (see illustration).
4. Remove Belt Access Door located near the **Floor Cleaning/Tools** switch by inserting a flat head screwdriver into the slot nearest to the handle and gently prying the access door off (see illustration).
5. Turn the machine onto its side so the belt access area is facing upward (see illustration).
6. On the bottom of the machine, near the belt access area, is a red retainer plate that holds the black brush arm and brush in place. Using a Phillips head screwdriver remove the screw that holds the red retainer plate in place. Set red retainer plate and Phillips head screw aside (see illustration).

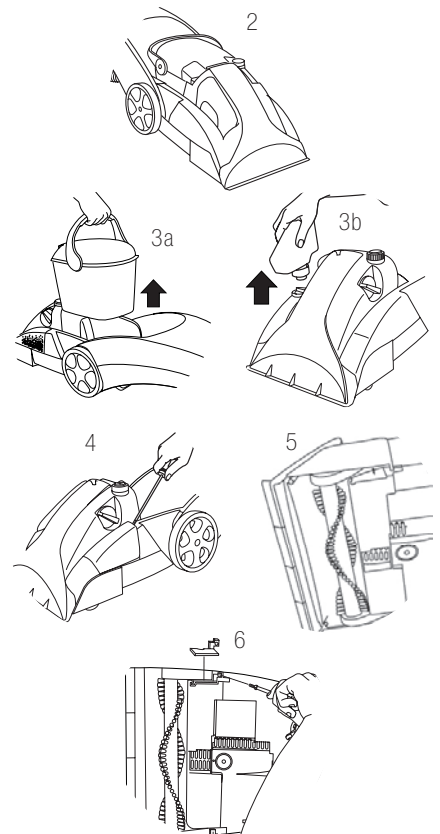

## Pump Belt Replacement Continued

7. Remove the black brush arm that holds the brush in place. Set the black brush arm aside (see illustration).
8. Remove the "toothed" Brush Belt from the brush then from the red pump pulley. Set the "toothed" Brush Belt and brush aside.
9. Locate and remove broken Pump Belt.

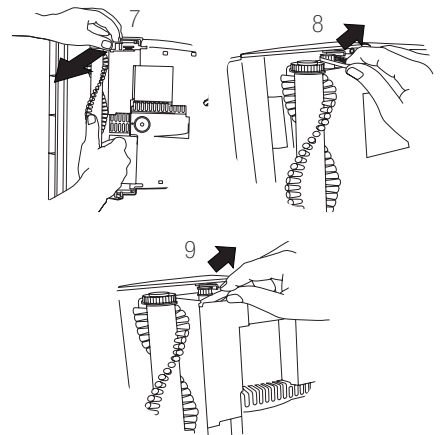

## To Install the Replacement Pump Belt

1. With the unit still on its side, loop one end of the replacement Pump Belt around the red pump pulley and then the other end around the silver motor shaft (see illustration). Do not twist the replacement Pump Belt.
2. Re-install the "toothed" Brush Belt first onto the red pump pulley and then onto the "toothed" end of the brush (see illustration).
3. Re-install the brush into the base of unit.
4. Place the black brush arm onto the brush and slide black brush arm into base of unit. The black brush arm and brush should slide easily into original position (see illustration).
5. Re-install the red retainer plate and Phillips head screw (see illustration).
6. Using your finger, gently spin the replacement Pump Belt on the silver motor shaft. If assembled correctly, the replacement Pump Belt should rotate freely around the silver motor shaft and drive pulley without obstruction. The brush should also rotate freely when the silver motor shaft is turned.
7. Turn the machine right side up and replace the Tank-In-Tank, SmartMix Bottle and Belt Access Door (see illustration).

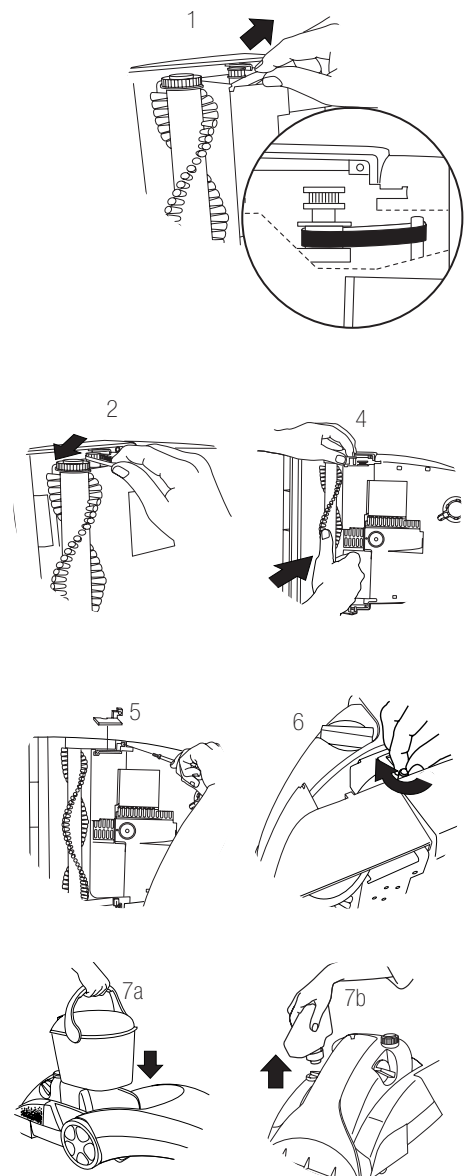

8. **Assembly is now complete.** If you have any questions, or are having trouble installing your replacement Pump Belt, please call BISSELL Consumer Services in the UK at 0870-225-0109. For all other countries call our USA Headquarters at 01-616-453-4451. Or visit the BISSELL website at [www.bissell.com](http://www.bissell.com).

**⚠️ WARNING:**  
To reduce the risk of fire, electric shock or injury unplug from outlet before servicing.

**SmartTemp Ready Light Does Not Illuminate.**

**Possible Causes**

- ❶ The Power Switch is not turned ON.

**Reduced Spray OR No Spray.**

**Possible Causes**

- ❶ Bladder may be empty.
- ❷ SmartMix Bottle may be empty.
- ❸ The Filter may be clogged.
- ❹ Tanks may not be seated properly.
- ❺ Pump may have lost prime.
- ❻ The Pump Belt may be broken.

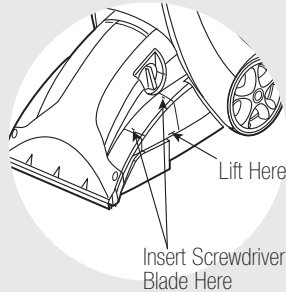

**Remedies**

- ❶ Turn the Power Switch ON.

**Remedies**

- ❶ Refill Bladder with clean hand hot tap water.
- ❷ Fill with any BISSELL Advanced Deep Cleaning Formula for cleaning or water if rinsing.
- ❸ Clean out Flow Indicator Filter, page 16.
- ❹ Turn Power Switch OFF; remove & reseal tanks. Inspect for presence of seals.
- ❺ Turn Power Switch OFF; after 1 minute turn ON and depress trigger.
- ❻ Turn Power Switch OFF and unplug from the outlet. To check if a Pump Belt has broken, you will need a flat head screwdriver. Insert the blade end into the lower slot of the Belt Access Door to release the lower snap. If necessary, insert the blade end into the upper slot to release the upper snap. Examine the belt for breakage. You should be able to see the Pump Belt looped around the motor shaft. If it is broken or missing, please refer to **Replacement Parts** on page 19 before calling BISSELL Consumer Services. Complete installation instructions will accompany the replacement Belt.

**DirtLifter PowerBrush Does Not Turn.**

**Possible Causes**

- ❶ The Brush Belt or Pump Belt is off or broken.

**Remedies**

- ❶ Turn Power Switch OFF and unplug from the outlet. To check if a Pump Belt has broken, you will need a flat head screwdriver. Insert the blade end into the lower slot of the Belt Access Door to release the lower snap. If necessary, insert the blade end into the upper slot to release the upper snap. Examine the belt for breakage. If broken refer to pages 16-17.

**Cleaner Not Picking Up Solution**

**Possible Causes**

- ❶ ReadyTools Dial may be at the wrong setting for the cleaning job.
- ❷ Nozzle Window may not be properly attached.
- ❸ Tank-in-Tank lid is not installed
- ❹ Tank-in-Tank is not properly seated.
- ❺ Poor tool position (Hand held attachments only).
- ❻ Tank-in-Tank has picked up maximum dirty water.

**Remedies**

- ❶ Set ReadyTools Dial to either **Tools/PreTreat** or **Floor Cleaning**.
- ❷ Press down firmly on the black oval gasket at the top window to make sure the two tabs on the back of the Nozzle Window are snapped into the mating slots in the main housing.
- ❸ Re-install lid; refer to the **Features** section.
- ❹ Tank-In-Tank must be firmly seated to function; remove and reseal Tank-in-Tank.
- ❺ Adjust angle; apply more downward pressure.
- ❻ Empty Tank-in-Tank, refer to the **Features** section.

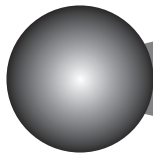

**If your BISSELL product should require service:**

In the UK call BISSELL Consumer Services at the number below and we will give you the location of a BISSELL Authorized Service Center in your area. For all other countries contact your local in country distributor for questions, service, or repair.

If you have questions about your warranty or need replacement parts please contact the numbers below.

**For UK inquiries:**

Monday - Thursday 9 am — 5 pm  
Friday 9 am — 4 pm

**BISSELL Homecare (Overseas) Inc.**

The Boat Yard  
105 Straight Road  
Old Windsor  
Berkshire, SL4 2SE  
United Kingdom  
Telephone: 0870-225-0109

**For all other inquiries:**

Monday - Friday 8 am — 4 pm

**BISSELL Homecare, Inc.**

PO Box 1888  
Grand Rapids, Michigan 49501 USA  
Telephone: 01-616-453-4451  
Fax: 01-616-453-1383

Or visit the BISSELL website - [www.bissell.com](http://www.bissell.com)

When contacting BISSELL, have model number of unit available.

Please record your Model Number: \_\_\_\_\_

Please record your Purchase Date: \_\_\_\_\_

**NOTE: Please keep your original sales receipt. It provides proof of date of purchase in the event of a warranty claim. See "About Your Warranty" on page 20 for details.**

Please do not return this product to the store.

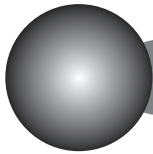

Replacement Parts - BISSELL PowerWash ProHeat

Item	Part No.	Part Name	1	2	3	4
1*	210-9213	4" Small Area Tool				
2*	603-0910	6" Stair Tool				
3*	210-9148	Spraying Crevice Tool				
4*	210-1197	TurboBrush™				
5*	214-9131	Bare Floor Tool				
6*	214-9142	PreTreat Wand				
7*	214-9150	3" Tough Stain Tool				
8	015-9043	Tank Assembly Complete (Includes Lid Assembly)				
9	015-4439	Tank Lid Assembly				
10	015-9041	Tank Bottom (Assembly)				
11	210-1785	SmartMix™ Bottle (Includes Cap Assembly)				
12	210-1795	SmartMix™ Cap Assembly				
13	555-6503	Flow Indicator Assembly				
14	210-4052	Window Gasket				
15	214-9874	Floor Nozzle Window and Gasket				
16	215-0628	Replacement Pump Belt (With Instructions)				
17	015-0621	Replacement Brush Belt (With Instructions)				
18	213-3501	Lint Screen				
19	410E™	950 ml Fibre Cleansing Formula™				
20	480	950 ml Floor Cleansing Formula				

\*Not all parts are included with every model.

## About Your Warranty

This warranty gives you specific legal rights, and you may also have other rights which may vary from country to country. If you need additional instruction regarding this warranty or have questions regarding what it may cover, please contact BISSELL Consumer Services by telephone, or regular post as described below, or contact your local in country distributor.

### Limited Two Year Warranty

Subject to the \*EXCEPTIONS AND EXCLUSIONS identified below, upon receipt of the product, BISSELL Homecare, Inc., will replace (with new or remanufactured components or products), at BISSELL's option, free of charge from the date of purchase by the original purchaser, for two years any defective or malfunctioning part due to manufacturers defect.

This warranty applies to product used for personal, and not commercial or rental service. This warranty does not apply to fans or routine maintenance components such as filters, belts, or brushes. Damage or malfunction caused by negligence, abuse, or use not in accordance with the User's Guide is not covered.

#### For UK inquiries:

Monday - Thursday 9 am — 5 pm  
Friday 9 am — 4 pm

#### **BISSELL Homecare (Overseas) Inc.**

The Boat Yard  
105 Straight Road  
Old Windsor  
Berkshire, SL4 2SE  
United Kingdom  
Telephone: 0870-225-0109

#### For all other inquiries:

Monday - Friday 8 am — 4 pm

#### **BISSELL Homecare, Inc.**

PO Box 1888  
Grand Rapids, Michigan 49501 USA  
Telephone: 01-616-453-4451  
Fax: 01-616-453-1383

**BISSELL HOMECARE INC. IS NOT LIABLE FOR INCIDENTAL OR CONSEQUENTIAL DAMAGES OF ANY NATURE ASSOCIATED WITH THE USE OF THIS PRODUCT. BISSELL'S LIABILITY WILL NOT EXCEED THE PURCHASE PRICE OF THE PRODUCT.**

#### **\*EXCEPTIONS AND EXCLUSIONS FROM THE TERMS OF THE LIMITED WARRANTY**

**THIS WARRANTY IS EXCLUSIVE AND IN LIEU OF ANY OTHER WARRANTIES EITHER ORAL OR WRITTEN. ANY IMPLIED WARRANTIES WHICH MAY ARISE BY OPERATION OF LAW, INCLUDING THE IMPLIED WARRANTIES OF MERCHANTABILITY AND FITNESS FOR A PARTICULAR PURPOSE, ARE LIMITED TO THE TWO YEAR DURATION FROM THE DATE OF PURCHASE AS DESCRIBED ABOVE.**



©2003 BISSELL HOMECARE, Inc.  
Grand Rapids, Michigan  
All rights reserved. Printed in USA.  
Part Number 310-5808  
Rev 04/03

Visit our website at:  
[www.bissell.com](http://www.bissell.com)