

This Owner's Manual is provided and hosted by [Appliance Factory Parts](#).



# LG TWC121CGMK0 Owner's Manual

[Shop genuine replacement parts for LG  
TWC121CGMK0](#)



[Find Your LG Air Conditioner Parts - Select From 2328 Models](#)

----- Manual continues below -----

## ROOM AIR CONDITIONER **OWNER'S MANUAL**

Please read the operating instructions and safety precautions carefully and thoroughly before installing and operating your room air conditioner.

## MANUEL D'UTILISATION **CLIMATISEUR DE FENÊTRE**

Veillez lire attentivement et en entier ce guide d'utilisation et les mesures de sécurité ci-incluses avant de procéder à l'installation et au fonctionnement de votre climatiseur.

## ACONDICIONADOR DE AIRE DE VENTANA **MANUAL DEL PROPIETARIO**

Por favor lea las instrucciones de operación y las precauciones de seguridad cuidadosa y totalmente antes de instalar y operar su acondicionador de aire de ventana.

MODEL, MODELE, MODELO: M1203R, KG1200R, WG1200R



# TABLE OF CONTENTS

|  |    |
|--|----|
| FEATURES .....                               | 2  |
| SAFETY PRECAUTIONS .....                     | 3  |
| OPERATING .....                              | 5  |
| FUNCTION .....                               | 5  |
| REMOTE CONTROLLER .....                      | 6  |
| VENTILATION.....                             | 7  |
| TO CONTROL AIR DIRECTION.....                | 7  |
| HOW TO SECURE THE DRAIN PIPE.....            | 7  |
| AIR FILTER CLEANING .....                    | 8  |
| HOW TO USE THE REVERSIBLE INLET GRILLE ..... | 8  |
| ELECTRICAL DATA .....                        | 9  |
| BEFORE CALLING FOR SERVICE .....             | 9  |
| INSTALLATION INSTRUCTIONS .....              | 10 |
| ELECTRICAL SAFETY.....                       | 14 |

## FEATURES

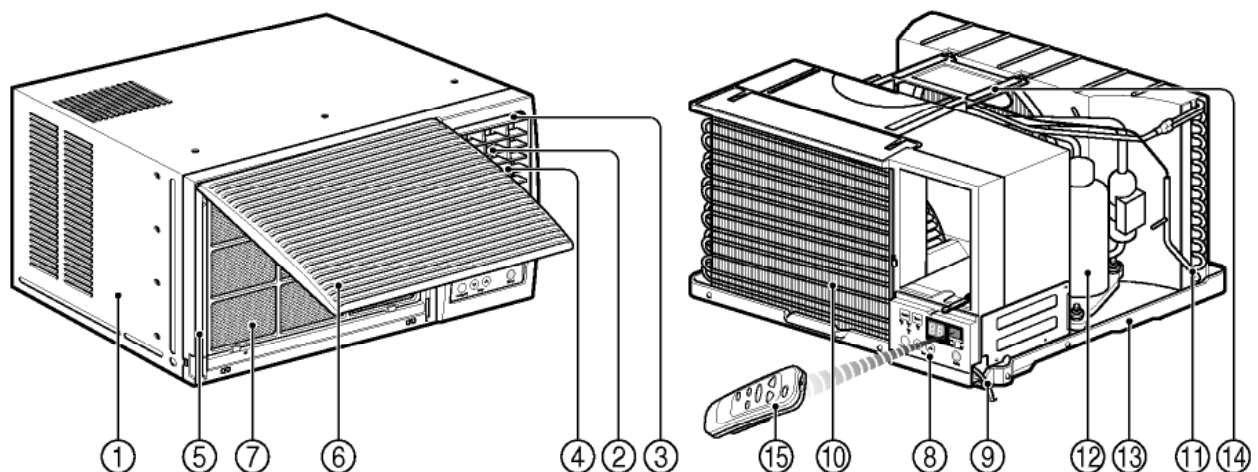



- |  |                       |
|--|-----------------------|
| 1. CABINET                                       | 7. AIR FILTER         |
| 2. HORIZONTAL AIR DEFLECTOR<br>(VERTICAL LOUVER) | 8. CONTROL BOARD      |
| 3. VERTICAL AIR DEFLECTOR<br>(HORIZONTAL LOUVER) | 9. POWER CORD         |
| 4. AIR DISCHARGE                                 | 10. EVAPORATOR        |
| 5. FRONT GRILLE                                  | 11. CONDENSER         |
| 6. AIR INTAKE<br>(INLET GRILLE)                  | 12. COMPRESSOR        |
|  | 13. BASE PAN          |
|  | 14. BRACE             |
|  | 15. REMOTE CONTROLLER |



# Safety Precautions

To prevent injury to the user or other people and property damage, the following instructions must be followed.





- Incorrect operation due to ignoring of instruction will cause harm or damage. The seriousness is classified by the following indications.

|   |  |
|---|--|
|  | <b>WARNING</b> : This symbol indicates the possibility of death or serious injury.             |
|  | <b>CAUTION</b> : This symbol indicates the possibility of injury or damage to properties only. |

- Meanings of symbols used in this manual are as shown below.

|   |   |
|---|---|
|  | <b>Be sure not to do.</b>                 |
|  | <b>Be sure to follow the instruction.</b> |

## **WARNING**

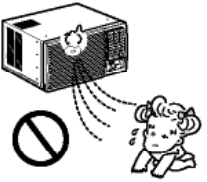
|   |  |  |
|---|--|--|
| <p><b>Plug in the power plug properly.</b></p> <ul style="list-style-type: none"> <li>• Otherwise, it will cause electric shock or fire due to heat generation.</li> </ul>                                 | <p><b>Do not operate or stop the unit by inserting or pulling out the power plug.</b></p> <ul style="list-style-type: none"> <li>• It will cause electric shock or fire due to heat generation.</li> </ul>  | <p><b>Do not damage or use an unspecified power cord.</b></p> <ul style="list-style-type: none"> <li>• It will cause electric shock or fire.</li> <li>• If the power cord is damaged, it must be replaced by the manufacturer or an authorized service center or a similarly qualified person in order to avoid a hazard.</li> </ul>  |
| <p><b>Do not modify power cord length or share the outlet with other appliances.</b></p> <ul style="list-style-type: none"> <li>• It will cause electric shock or fire due to heat generation.</li> </ul>  | <p><b>Do not operate with wet hand or in damp environment.</b></p> <ul style="list-style-type: none"> <li>• It will cause electric shock.</li> </ul>    | <p><b>Do not direct airflow at room occupants only.</b></p> <ul style="list-style-type: none"> <li>• This could damage your health.</li> </ul>    |