

This Owner's Manual is provided and hosted by [Appliance Factory Parts](#).



LG LCE3010SB Owner's Manual

[Shop genuine replacement parts for LG LCE3010SB](#)



[Find Your LG Electric Range Parts - Select From 91 Models](#)

----- Manual continues below -----



ENGLISH

ESPAÑOL

FRANÇAIS

OWNER'S MANUAL

CERAMIC-GLASS RADIANT COOKTOP

Please read this guide thoroughly before operating
and keep it handy for reference at all times.

LCE3010SB
LCE3610SB

INTRODUCTION

IMPORTANT SAFETY INFORMATION

Important Safety Precautions 3–7

COOKWARE TIPS

Selecting Cookware 8–9

PARTS AND FEATURES

Parts and Features of Your Cooktop 10

Touch Control Features 11

OPERATING INSTRUCTIONS

Before Using the Cooktop 12

Setting the Controls 12–14

Using the Warming Zones 14

Using the Triple cooking zones 15

Using the Dual cooking zones 15

Using the Child lock 16

Other Functions 16

CARE AND CLEANING

Cleaning the Cooktop 17

INSTALLATION INSTRUCTIONS

Before You Begin 18

Unpacking the Cooktop 18

Technical Specifications 19

Preparing the Installation Location 20

Dimensions and Clearances 21

Preparing the Installation Location 22

Dimensions and Clearances 23

Electrical Connections 24–26

Cooktop Installation 26–27

Final Check 27

TROUBLESHOOTING

Before Calling for Service 28–29

WARRANTY

Warranty for customers in the U.S.A. 30

Warranty for customers in Canada 31

THANK YOU!

Congratulations on your purchase
and welcome to the LG family.

Your new LG RADIANT Cooktop
combines precision cooking
features with simple operation
and stylish design. By following
the operating and care instructions
in this manual, your cooktop will
provide you with many years of
reliable service.

Product Registration Information

Model: _____

Serial Number: _____

Date of Purchase: _____

IMPORTANT SAFETY INFORMATION

READ ALL INSTRUCTIONS BEFORE USE

⚠ WARNING For your safety, the information in this manual must be followed to minimize the risk of fire, electric shock, or to prevent property damage, personal injury, or death.

SAFETY PRECAUTIONS

- **Proper Installation:** Be sure your appliance is properly installed and grounded by a qualified technician in accordance with the National Electrical Code ANSI/NFPA No. 70, latest edition in the United States, and all local code requirements. Install only per installation instructions.
- Do not attempt to repair or replace any part of your cooktop unless it is specifically recommended in this manual. All other service should be referred to a qualified technician.
- Remove all tape and packaging wrap before using the appliance. Destroy the carton and plastic bags after unpacking the appliance. Never allow children to play with packaging material.
- The safety aspects of this appliance comply with accepted technical standards.
- **Know how to disconnect the electrical power to the appliance at the circuit breaker or fuse box in case of an emergency.** Mark the breaker or fuse for ease of identification and swift action if necessary.
- **Do not repair or replace any part of the appliance.** All servicing should be done only by a qualified technician to avoid the risk of personal injury and damage to the appliance.
- **Never modify or alter the construction of an appliance such as removal of panels, wire covers or any other permanent part of the product.**
- **Storage on appliance: Flammable materials should not be stored near or on the cooking surface.** This includes paper, plastic and cloth items, such as cookbooks, plasticware and towels, as well as flammable liquids. Do not store explosives, such as aerosol cans, on or near the appliance. Flammable materials may explode and result in fire or property damage.
- **Do not leave children alone. Children should not be left alone or unattended in the area where an appliance is in use.** They should never be allowed to sit or stand on any part of the appliance.

- **Do not store or use gasoline or other flammable vapors and liquids in the vicinity of this or any other appliance.**

⚠ CAUTION

Items of interest to children should not be stored in cabinets above a cooktop or on the backsplash of a cooktop—children climbing on the cooktop to reach items could be seriously injured.

⚠ WARNING

Never use your appliance for warming or heating a room.

⚠ CAUTION

DO NOT touch Cooking Zones or areas near these surfaces. Cooking Zones may be hot from residual heat even though they are dark in color. Areas near the Cooking Zones may become hot enough to cause burns. During and after use, do not touch or let clothing or other flammable materials touch these areas until they have had sufficient time to cool.

⚠ CAUTION

Never wear loose fitting or hanging garments while using this appliance.

- Always turn off all controls when cooking is completed.
- Never allow children to set or stand on any parts of the appliance as they could be injured or burned.

IMPORTANT SAFETY INFORMATION

READ ALL INSTRUCTIONS BEFORE USE

SAFETY PRECAUTIONS (cont.)

- **Wear proper apparel. Loose-fitting or hanging garments should never be worn while using the appliance.** Do not let clothing or other flammable materials contact hot surfaces.
- **Do not use water or flour on grease fires.** Smother the fire with a pan lid, or use baking soda, a dry chemical or foam-type extinguisher.
- **When heating fat or grease, watch it closely.** Fat or grease may catch fire if allowed to become too hot.
- **Use only dry pot holders.** Moist or damp pot holders on hot surfaces may result in burns from steam. Do not let the pot holders touch hot surface units. Do not use a towel or other bulky cloth instead of a pot holder.
- **Do not heat unopened food containers.** Buildup of pressure may cause the container to burst and result in injury.

ELECTRICAL SAFETY

WARNING

- If the surface is cracked, switch off the appliance to avoid the possibility of electric shock. Do not reuse your COOKTOP until the glass surface has been changed.
- When using the COOKTOP, never use aluminum foil, products wrapped in aluminum foil, or deep-frozen food in aluminum cookware.
- If the supply cord is damaged, it must be replaced by the manufacturer, its service agent or similarly qualified persons in order to avoid a hazard.

- The installation and connection of the new appliance must only be carried out by qualified personnel.
- Flush-mounted appliances may only be operated following installation in suitable cabinets and workplaces which conform to the relevant standards. This ensures sufficient protection against electric shock as required by certification agencies.
- If your appliance malfunctions or fractures, switch off all cooking zones, and contact Service Center.

CHILD SAFETY

WARNING

- This appliance is not intended for use by young children or infirm persons unless they have been adequately supervised by a responsible person to ensure that they can use the appliance safely.

- Young children should be supervised to ensure that they do not play with the appliance.
- Accessible parts may become hot during use. Young children should be kept away.

IMPORTANT SAFETY INFORMATION

READ ALL INSTRUCTIONS BEFORE USE

SAFETY DURING USE

- **This appliance may only be used for normal cooking and frying in the home.** It is not designed for commercial or industrial purposes.
- **Do not use the cooktop to heat the room.**
- **Take care when plugging in electric appliances near the cooktop.** Cords must not come into contact with the hot surface. This could cause damage to the cooktop and cable insulation.
- **Overheated fats and oils catch fire quickly.** You should supervise cooking when preparing foods in fat or oil.
- **After use, switch off the hob element by its control and do not rely on the pan detector.**
- **Always keep the control panels clean and dry.** Do not let liquids or grease remain on the cooktop controls area. Spilled or burnt-on foods can activate or deactivate the appliance. Clean the controls area thoroughly to resume normal operation of the appliance.
- **Never place combustible items on the cooktop.**
- **Never keep any combustible items or aerosol cans in a drawer located under the cooktop.**
- **Avoid placing metal cooking utensils on the cooking surface areas.** Metal objects can become hot and cause burns.
- **Know which touch keypad controls each surface of the cooking zones.**
- **Clean the appliance regularly to keep all parts free of grease that could catch fire.** Exhaust fan ventilation hoods and grease filters should be kept clean. Do not allow grease to accumulate on hood or filter. Greasy deposits in the fan could catch fire. Refer to hood manufacturer's instructions for cleaning.
- **Use Proper Pan Sizes.** This appliance is equipped with one or more surface units of different size. Select utensils having flat bottoms large enough to cover the surface unit heating element. The use of undersized utensils will expose a portion of the heating element to direct contact and may result in ignition of clothing. Proper relationship of utensil to burner will also improve efficiency.
- **If pan is smaller than element,** a portion of the element will be exposed to direct contact and could ignite clothing or potholder.
- **Do not place any object on or near the control keypad area in order to prevent accidental activation of the cooktop controls.**
- **Utensil Handles Should Be Turned Inward and Not Extend Over Adjacent Surface Units.** To reduce the risk of burns, ignition of flammable materials, and spillage due to unintentional contact with the utensil, the handle of a utensil should be positioned so that it is turned inward, and does not extend over adjacent surface units.
- **Never leave prepared food on the Cooking Zones.** Boilovers cause smoking and greasy spillovers that may ignite, or a pan that has boiled dry may melt or become damaged.
- **Protective liners: Do not use aluminum foil to line any part of the cooktop.** Only use aluminum foil as recommended after the cooking process, if used as a cover to be placed over the food. Any other use of aluminum foil may result in the risk of electric shock, fire or short circuit.
- **Glazed cooking utensils: Only certain types of glass, glass/ceramic, ceramic, earthenware, or other glazed utensils are suitable for rangetop service without breaking due to the sudden change in temperature.** Check the manufacturer's recommendations for cooktop use.
- **Ventilating hood: The ventilating hood above your cooking surface should be cleaned frequently, so the grease from cooking vapors does not accumulate on the hood or filter.**
- **Do not clean or operate a broken cooktop.** If cooktop should break, cleaning solutions and spillovers may penetrate the broken cooktop and create a risk of electric shock. Contact a qualified technician immediately.
- **Clean cooktop with caution.** Do not use sponges or cloth to wipe spills on a hot cooking area. Use a proper metal scraper.

IMPORTANT SAFETY INFORMATION

SAFETY DURING USE (cont.)

- **Do not place hot cookware on cold cooktop glass.** This could cause glass to break.
- **Do not slide pans across the cooktop surface.** They may scratch the cooktop surface.
- **Do not let pans boil dry.** This may cause permanent damage in the form of breakage, fusion, or marking that can affect the ceramicglass cooktop. (This type of damage is not covered by your warranty.)
- **Never leave surface units unattended at high heat settings.** Boilover causes smoking and greasy spillovers that may ignite.
- Smother fire or flame in a pan with a lid or cookie sheet. **NEVER** pick up or move a flaming pan.
- Do not use water on grease fires. Use baking soda a dry chemical or foam-type extinguisher to smother fire or flame.
- **Always turn off all controls when cooking is completed.**
- **Be sure you know which control pads operate each surface unit.** Make sure you turned on the correct surface unit.
- **Use only dry potholders.** Moist or damp pot holders on hot surfaces may result in burns from steam. Do not let the pot holder touch hot heating elements. Do not use a towel or other bulky cloth.

SAFETY WHEN CLEANING

- Always switch off the appliance before cleaning.
- For safety reasons, do not clean the appliance with a steam jet or high-pressure cleaner.
- Clean the cooktop in accordance with the maintenance and cleaning instructions in this manual.
- Steam cleaner is not to be used for cleaning of the cooktop.
- Do not use harsh abrasive cleaners or rough metal scrapers to clean the cooktop glass since they can scratch the surface, which may result in shattering of the glass.
- **Clean CookTop With Caution.** Do not use sponges or cloth to wipe spills on a hot cooking area. Use a proper metal scraper.

COOK MEAT AND POULTRY THOROUGHLY

Cook meat and poultry thoroughly—meat to at least an INTERNAL temperature of 160°F and poultry to at least an INTERNAL temperature of 180°F. Cooking to these temperatures usually protects against foodborne illness.

IMPORTANT SAFETY INFORMATION

HOW TO AVOID DAMAGE TO THE APPLIANCE

- Prior to using your cooktop for the first time, apply the recommended cooktop cleaning creme to the ceramic surface. Buff with a non-abrasive cloth or pad. This will make cleaning easier when soiled from cooking.
The special cooktop cleaning cream leaves a protective finish on the glass to help prevent scratches and abrasions.
- Do not use the cooktop as a worksurface or storage space.
- Please be careful at the edges when moving pots and pans.
- Do not operate the cooking zones with empty pots or pans.
- Do not turn on the cooking zones with no pots or pans on the element.
- Ceramic glass is very tough, and impervious to sharp temperature changes but is not unbreakable. It can be damaged if hard or sharp objects fall on it.
- Be very cautious if using pots made of cast iron, or other pots with rough edges or burrs. Moving these can cause scratches on glass.
- If sugar or a mixture containing sugar falls onto a hot cooking zone and melts, remove immediately, while still hot. If left to cool down, it may damage the surface when removed.
- Do not slide metal or glass across the cooktop surface.

- Keep meltable objects or materials away from the ceramic glass surface, for example, plastic utensils, aluminum foil, or cooking wraps. If any materials or foodstuffs melt on the ceramicglass surface, these should be cleaned up immediately.

NOTE: There is a risk of burning yourself when the glass scraper is used on a hot cooking zone!

- Do not use cookware with any dirt build up on the bottom.
- Do not use cookware with rough or uneven bottoms. This cookware can mark and scratch the cooktop surface.
- Refer to the owners manual for proper cleaning and maintenance of the cooktop.
- **Do not use the glass cooktop surface as a cutting board.**
- **Never cook directly on the galss. Always use cookware.**

CAUTION

Burn Hazard: The Cooking Zones may appear cool when turned ON and after they have been turned OFF.

DISPOSAL OF OLD APPLIANCES

To protect the environment, it is important that worn-out appliances are disposed of in the correct manner.

- The appliance must not be disposed of with household rubbish.
- You can obtain information about collection dates or public refuse disposal sites from your local health council or environmental health office.

CAUTION

Before disposing of old appliances please make them inoperable so they cannot be a source of danger. To do this, have a qualified person disconnect the appliance from the house circuitry.

READ AND FOLLOW THIS SAFETY INFORMATION CAREFULLY.

SAVE THESE INSTRUCTIONS

COOKWARE TIPS

SELECTING COOKWARE

POTS AND PANS

The better the pot, the better the cooking results.

- You can recognize good pots and pans by their bases. The base should be as thick and flat as possible.

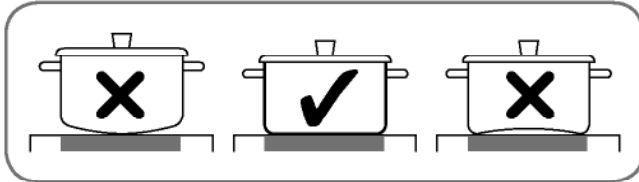

- Pots with aluminum or copper bases can cause metallic discoloring on the ceramic glass surface which is very difficult or impossible to remove.
- Be very careful when using cast iron pots or pots with damaged bases which are rough and or have burrs on them. Scratches can occur if they are slid across the surface.
- When cold, pot bases are normally bowed slightly inwards (concave). They should never be bowed outwards (convex).
- If you wish to use a special type of pan (e.g., a pressure cooker, simmering pan, wok), please follow the manufacturer's instructions and do not use a very thin pan.

USE FLAT-BOTTOMED COOKWARE

Cookware must fully contact the surface of the cooking element. Use flat-bottomed pans sized to fit the cooking element and amount of food being prepared. Check for flatness by rotating a ruler across the bottom of the cookware.

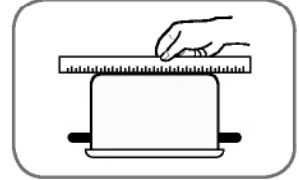

SELECTING COOKWARE (cont.)

AVOIDING SCRATCHES

It is recommended to always use heavier gauge stainless steel cookware on your ceramic cooktop surface. This will help reduce the possibility of developing scratches on the ceramic surface. Low-quality cookware can scratch the cooktop surface.

Cookware should always be lifted over the ceramic cooktop surface to prevent scratching.

Sliding any type of cookware over the ceramic cooktop can affect the overall appearance of the cooktop. Over time, sliding ANY type of cookware over the ceramic cooktop may alter the overall appearance of the cooktop. Eventually, the buildup of scratches can make cleaning the surface difficult and degrade the overall appearance of the cooktop.

Scratches can also result from grains of sand (e.g., after washing vegetables) which are dragged with the pot across the cooking surface.

FOR BEST RESULTS:

Always follow the recommendations for proper cookware type and size. In addition:

- Do not use dirty pans with grease buildup. Always use pans that are easy to clean after cooking, and make sure that the bottoms of the pans are clean and dry.
- When cooking with large amounts of liquid, use large pots so that nothing can boil over.
- Do not let pans boil dry. This may cause permanent damage in the form of breakage, fusion, or marring that can affect the ceramic cooktop. (This type of damage is not covered by your warranty.)
- Match the pan size and Cooking Zone to the amount of food being prepared.

TIPS FOR SAVING ENERGY:

- Always position pots and pans before you switch on the Cooking Zone.
- Dirty cooking zones and cookware use more electricity.
- Whenever possible, always have the lid firmly placed on the pots and pans so that they are completely covered.

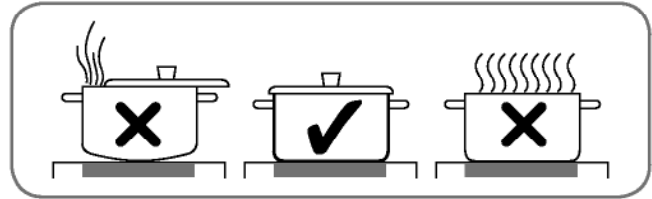

- Switch off the cooking zones before the end of the cooking time to use the residual heat for keeping food warm or for melting purpose.
- The base of the pot should have the same size as the cooking zone.

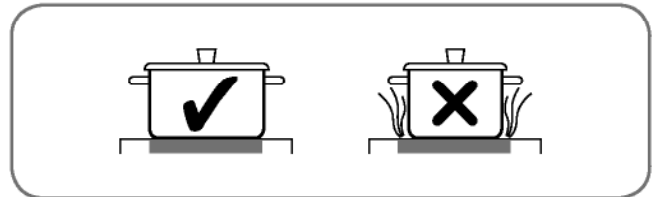

- Using a pressure cooker shortens the cooking times by up to 50%.

PARTS AND FEATURES

PARTS AND FEATURES OF YOUR COOKTOP

Throughout this manual, features and appearance may vary from your model.

LCE3010SB Radiant Cooktop

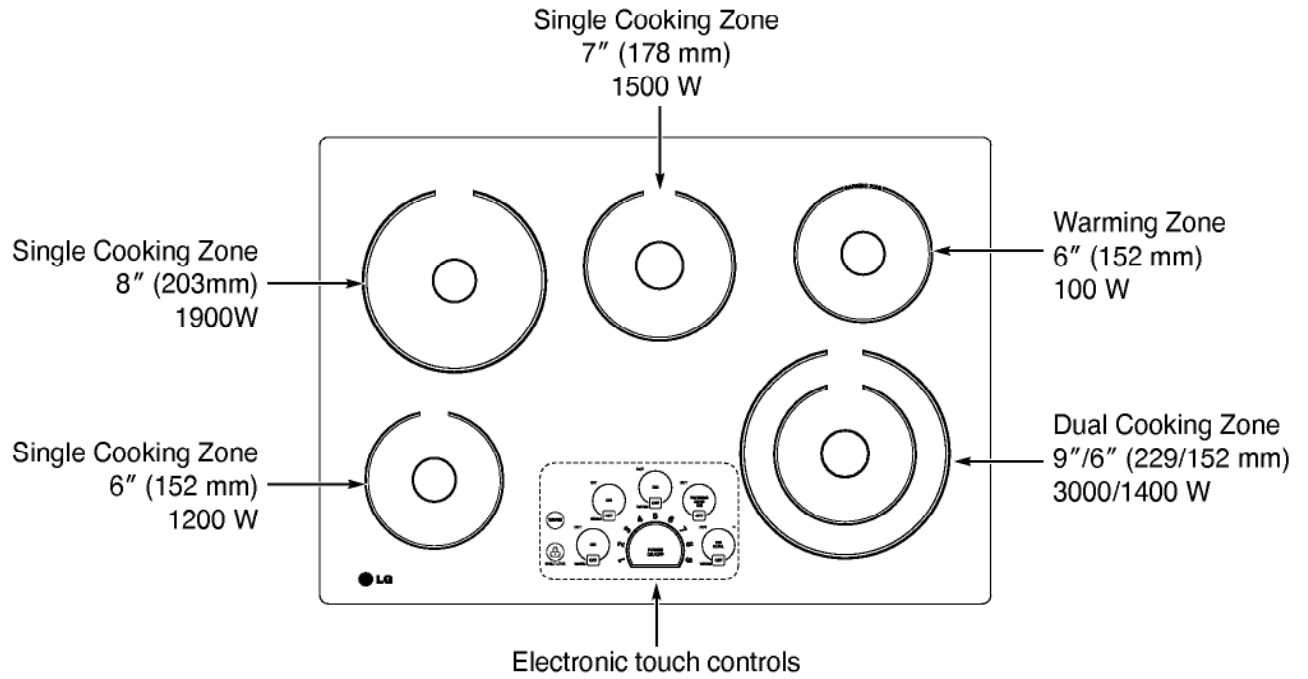

LCE3610SB Radiant Cooktop

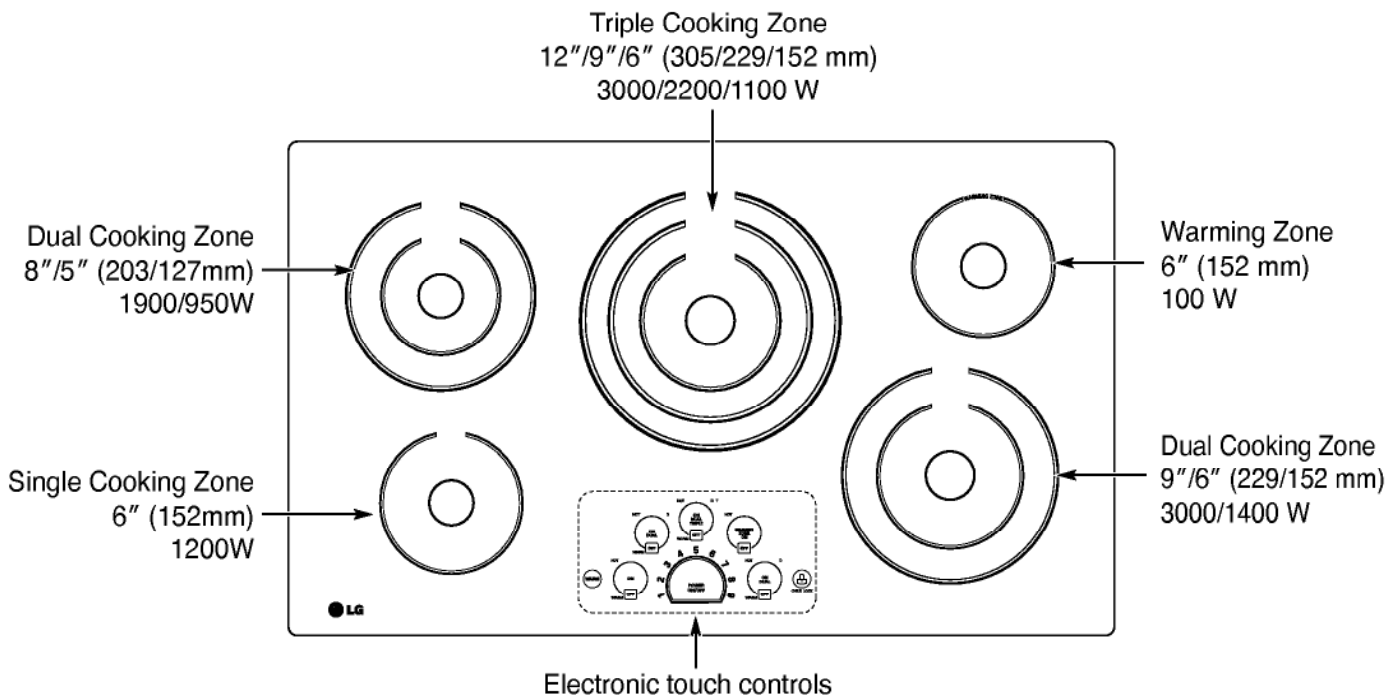

TOUCH CONTROL FEATURES

LOCATIONS OF SURFACE ELEMENTS AND CONTROLS

The surface burner elements are positioned in the same locations on the cooktop and the control panel for ease of use.

LCE3010SB Radiant Cooktop

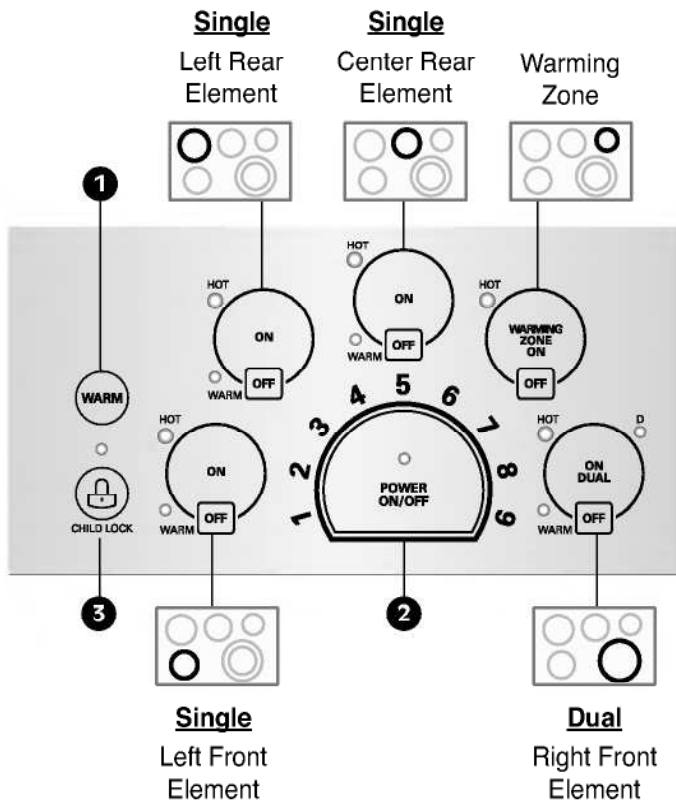

LCE3610SB Radiant Cooktop

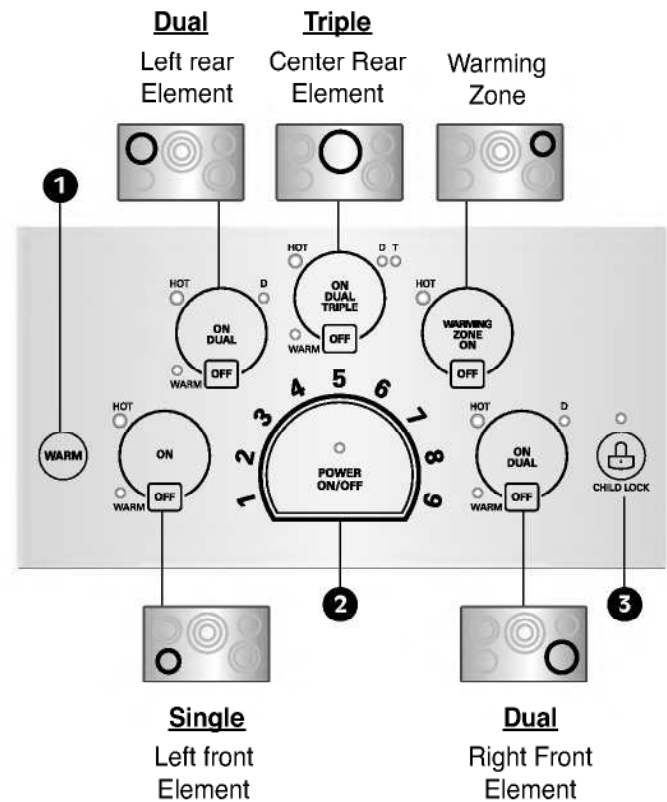

- 1 WARM:** This pad lowers selected active element to the lowest setting.
- 2 POWER ON/OFF:** Touch the POWER ON/OFF pad to turn the entire cooktop ON and OFF. When it is ON, the cooktop is in standby mode until a Cooking Zone is activated.
- 3 CHILD LOCK:** Touch and hold for 3 seconds to activate and deactivate the child lockout function.

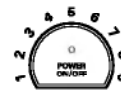

To set the element power level: Select the number on the element power settings for the active Cooking Zone to adjust the power level from 1 to 9.

Hot Surface Indicator: The indicator light below the HOT will illuminate when the cooking area is hot. It will remain on, even after the control is turned off, until the area has cooled.

OPERATING INSTRUCTIONS

BEFORE USING THE COOKTOP

Before using the cooktop for the first time, clean it thoroughly with the included cleaner or ceramic cooktop cleaner according to the Care and Cleaning instructions in this guide. This will help protect the ceramic surface and make future cleanup easier.

CAUTION

Never use scrub pads, abrasive or etching cleaners. They can cause permanent damage to the cooktop surface.

SETTING THE CONTROLS

To operate the touch control pads, touch the pad firmly with the flat part of your fingertip.

FIRST OPERATION

The first time that power is supplied to the cooktop, the display for the controls lights for 1 seconds. If you don't turn on the cooktop within 1 hour after power is supplied to the cooktop, the display for the controls blinks.

ACTIVATING THE COOKTOP



To turn ON the cooktop, touch the **POWER ON/OFF** pad for approximately 2 seconds. The indicator above the pad will light.

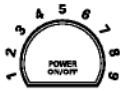

To turn OFF the cooktop, touch the **POWER ON/OFF** pad. The indicator light above the pad will turn off.

NOTE: After turning on the cooktop with the POWER ON/OFF pad, you must select one of the Cooking Zones within 15 seconds using the Cooking Zone ON pad(s). If no selection is made, the cooktop will turn off for safety.

SELECTING THE COOKING ZONE

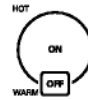

To select the desired Cooking Zone, touch the **ON** pad.



The display for the selected Cooking Zone will light. The power level indicator lights are blinking but no power level is set

NOTE: Once the Cooking Zone has been selected with the ON pad, the power level must be selected within 10 seconds with the Element power settings. Otherwise, the Cooking Zone will turn off for safety.

SETTING THE CONTROLS (cont.)

SETTING THE POWER LEVEL

The power level for the selected Cooking Zone can be set from 1 to 9.

To select the power level:

- 1 Select the number on the element power settings for the active Cooking Zone to adjust the power level from 1 to 9.
- 2 Selecting 7 will activate the Cook Zone. After activating the Cook Zone, the indicator lights will flash once and lock your selection.

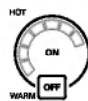
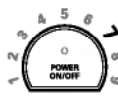
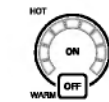

NOTE: If power level is not selected, the Cooking Zone will turn off after 10 seconds.

To readjust the power level:

- 1 Select Cooking Zone ON.
- 2 To change the Cooking Zone power, select the desired level. If power level is not selected after 10 seconds, the Cooking Zone power level will remain the same.

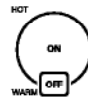

To turn OFF the Cooking Zone:

- 1 After the cooking is complete, touch the **OFF** pad to turn off the Cooking Zone.
- 2 The corresponding cooking zone display will turn off.
- 3 If the POWER ON/OFF pad is selected, all Cooking Zones will shut off.

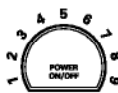
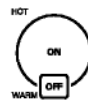

WARNING

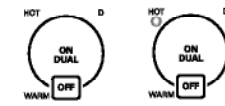

Your cooktop has a residual heat indicator for each Cooking Zone. This indicator will warn that this area has been used and is still giving off enough heat to cause burns. Avoid touching the Cooking Zone when this indicator is shown. Although the cooktop is OFF, the light will stay lit until the cooktop has cooled down.

Setting	Function	Used for
9	Fast heating	Bringing liquids to a boil.
7-9	Heaving browning, deep fat frying	Browning meats, heating oil for deep-fat frying, sautéing, maintaining a fast boil for large amounts of liquids.
6-7	Roasting, frying	Frying meats, chops, pancakes, sausages, eggs.
4-5	Boiling, general cooking	Cooking larger quantities, soups and stews, steaming potatoes, cooking meat stock or bouillon.
3-4	Steaming	Steaming vegetables, braising meats.
2-3	Simmering	Simmering rice or milk-based dishes, steaming smaller quantities of potatoes and vegetables, heating ready-to-serve meals.
1-2 Warm	Melting	Fluffy omelettes, keeping dishes warm, melting butter or chocolate.

NOTE: These settings are recommended guidelines for cooking. You may need to adjust the power level for the type of food and pan.

OPERATING INSTRUCTIONS

SETTING THE CONTROLS (cont.)

WARM

The cooktop has a WARM setting feature that can be used on all Cooking Zone except the Warming Zone element.

To activate:

Touch the **ON** pad to activate the desired Cooking Zone and touch the WARM pad. The selected Cooking Zone will be set to the LOW setting. The indicator light above WARM will turn ON.



To change the power level:

Touch the **ON** pad and select a new number on the element power settings. The indicator light above WARM will turn OFF.

USING THE WARMING ZONE

WARMING ZONE

Use the Warming Zone to keep cooked foods warm, such as vegetables, gravies and oven-safe dinner plates.

To activate the warming zone:



Touch the **WARMING ZONE ON** pad.
Set the desired power level on the element power settings.

Warming level guide

Settings	Used
1-2	Pastries Breads Breakfast Foods (Eggs) Delicate Foods
3-5	Soups (Cream) Stews Vegetables Meats
6-8	Sauces Gravies
9	Hot Beverages Soups (Liquid)

NOTE:

- All foods should be covered with a lid or aluminum foil to maintain food quality.
- When warming pastries and bread, the cover should have an opening to allow moisture to escape.
- Do not use plastic wrap to cover foods. Plastic may melt on to the surface and be very difficult to clean.
- Use only cookware and dishes recommended as safe for cooktop use.
- Always use potholders when removing food from the Warming Zone as cookware and plates will be hot.
- Never warm food for longer than one hour (eggs for 30 minutes), as food quality may deteriorate.
- Do not heat cold food on the Warming Zone.
- The quantity and type of food being held may affect the required heat setting
- Do not use large utensils or large amounts of food as this may cause uneven heating.
- Always hold food at proper food temperatures. USDA recommends food temperatures between 140° - 170° F (except pastries).

USING THE TRIPLE COOKING ZONES (LCE3610SB only)

The Triple Element, located in the center position, offers three different size elements to accommodate different pan sizes.

To Activate the Triple Cooking Zone

- 1 Touch the **ON** pad. The inner most element will activate.
- 2 Touch the **ON** pad again to activate the center and middle areas (Dual Element).

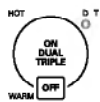
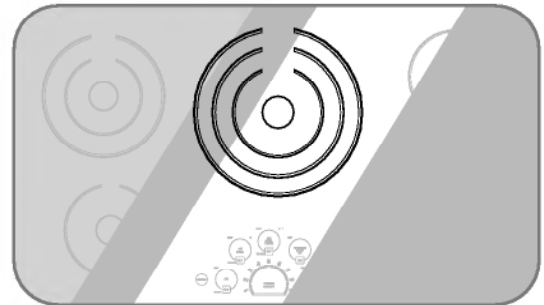
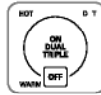

The indicator light below the **D** (Dual) will turn ON.

- 3 Touch the **ON** pad again to activate the entire element (Triple Element).

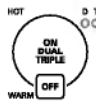

The indicator light below the the **D** (Dual) and **T** (Triple) will turn on.

- 4 Select the desired power level.

USING THE DUAL COOKING ZONES

The Dual Element, located in the right front position, offers two different size elements to accommodate different pan sizes. Use one or two sections of the element to accommodate different pan sizes.

To Activate the Dual Cooking Zone

- 1 Touch the **ON** pad. The inner most element will activate.
- 2 Touch the **ON** pad again to activate the entire element (Dual).

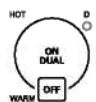
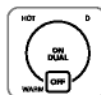

The indicator light below the **D** (Dual) will turn ON.

- 3 Select the desired power level.

LCE3010SB only

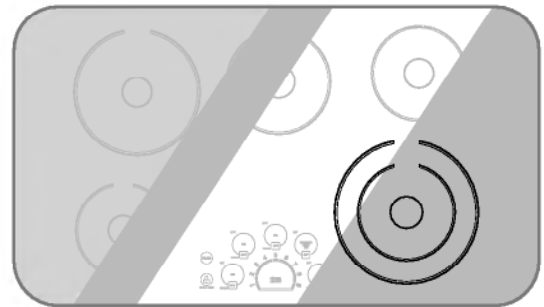

LCE3610SB only

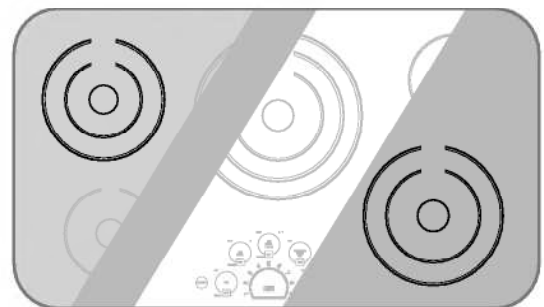

OPERATING INSTRUCTIONS

USING CHILD LOCK

You can lock the entire cooktop at any time when it is not in use. Locking the cooktop will prevent Cooking Zones from being turned on accidentally.

SETTING CHILD LOCK



The cooktop must be OFF to set the **CHILD LOCK** function. If it is not OFF, touch and hold the **POWER** pad for approximately 2 seconds. The indicator above the **POWER** pad will turn OFF.



Touch and hold the **CHILD LOCK** pad for 3 seconds. The indicator light above the **CHILD LOCK** pad will turn on to indicate that the cooktop is locked.

CANCELING CHILD LOCK



To turn off CHILD LOCK, touch and hold the **CHILD LOCK** pad for 3 seconds. The indicator light above the pad will go off and the cooktop can now be used normally.

OTHER FUNCTIONS

AUTOMATIC SHUTOFF

If a Cooking Zone is in constant use for more than 17 hours and the control setting is not changed, the Cooking Zone will shut off automatically.

AUTOMATIC POWER LEVEL CONTROL

The power level displayed may be different from the actual power level at the high temperature range. To prevent the cooktop from overheating, the power level is controlled automatically.

CLEANING THE COOKTOP

NORMAL DAILY USE CLEANING

ONLY use Ceramic Cooktop Cleaner on the glass cooktop. Other creams may not be as effective or they might damage the surface with scratches or permanent staining.

To maintain and protect the surface of your glass cooktop, follow these steps:

- 1 Before using the cooktop for the first time, clean it with Ceramic Cooktop Cleaner. This helps protect the top and makes cleanup easier.
- 2 Daily use of Ceramic Cooktop Cleaner will help keep the cooktop looking new.
- 3 Shake the cleaning cream well. Apply a few drops of Cleaner directly to the cooktop.
- 4 Use a paper towel clean the entire cooktop surface.
- 5 Rinse with clear water and use a dry cloth or paper towel to remove all cleaning residue.

NOTE:

It is very important that you **DO NOT** heat the cooktop until it has been cleaned thoroughly.

CAUTION

- **DO NOT use scrub pads or abrasive cleaning pads.**
- They may damage your glass cooktop surface.
- **For your safety please wear an oven mitt potholder while cleaning the hot cooking surface.**

BURNED-ON RESIDUE

To clean the glass-ceramic

Step. 1

First remove any burnt-on deposits or spilled food from your glass-ceramic cooking surface with a suitable metal razor scraper (similar to scraping paint off of your windowpanes in your home - it will not damage the decorated cooking surface). Hold the scraper at approximately a 30° angle to the cooktop.

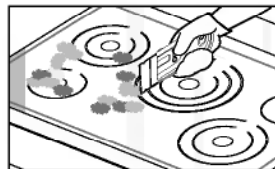

NOTE: Do not use a dull or nicked blade. For your safety, please wear an oven mitt potholder while using the metal scraper.

Step. 2

When the cooking surface has cooled down apply a few dabs (about the size of a dime) of an approved cleaner in each burner area and work the cleaning cream over the cooktop surface with a damp paper towel as if you were cleaning a window.

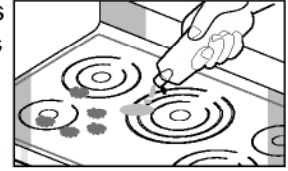

NOTE: Approved cleaner
Weiman CookTop Cleaning Cream (www.weiman.com)
Cerama Bryte (www.ceramabryte.com)
Hope's Cooktop Cleaning Cream (www.camden-industrial.com)
Easy-Off 3 in 1 Glass Top Cleaner Spray (www.easyoff.com).

Step. 3

As a final step, clean with clear water and wipe the cooktop surface with a clean, dry paper towel.

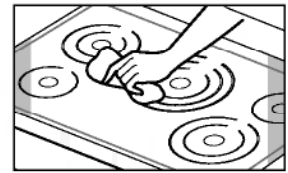

Important: If any sugar or food containing sugar (preserves, ketchup, tomato sauce, jellies, fudge, candy, syrups, chocolate, etc.), a plastic item or kitchen foil accidentally melts on the hot surface of your cooktop, remove the molten material **IMMEDIATELY** with a metal razor scraper (it will **not** damage the decorated cooking surface) **while the cooking surface is still hot** to avoid the risk of damage to the glass-ceramic surface. **For your safety please wear an oven mitt potholder while cleaning the hot cooking surface.**

METAL MARKS AND SCRATCHES

- 1 Be careful not to slide pots and pans across your cooktop. It will leave metal markings on the cooktop surface. These marks are removable using the Ceramic Cooktop Cleaner with the Cleaning Pad for Ceramic Cooktops.
- 2 If pots with a thin overlay of aluminum or copper are allowed to boil dry, the overlay may leave black discoloration on the cooktop. This should be removed immediately before heating again or the discoloration may be permanent.

INSTALLATION INSTRUCTIONS

INSTALLATION INSTRUCTIONS AND SERVICE MUST BE PERFORMED BY A QUALIFIED INSTALLER.

IMPORTANT: SAVE THESE INSTRUCTIONS FOR LOCAL ELECTRICAL INSPECTOR'S USE. READ AND SAVE THESE INSTRUCTIONS FOR FUTURE REFERENCE.

BEFORE YOU BEGIN

Read these instructions completely and carefully.

NOTES TO INSTALLER:

- Read all instructions contained in these installation instructions before installing the cooktop.
- Remove all packing material before connecting the electrical supply to the cooktop.
- Observe all governing codes and ordinances.
- Only certain cooktop models may be installed over certain built-in electric oven models.
- Be sure to leave these instructions with the consumer.

NOTE TO CONSUMER:

Keep this User's Guide and Installation Instructions for future reference.

NOTE: This appliance must be properly grounded.

Damage caused by failure to follow these instructions is not covered by the cooktop warranty.

UNPACKING THE COOKTOP

❶ Unpack and visually inspect the cooktop for any damage or missing components.

❷ Be sure the bottle of cleaner and conditioner packed in the literature bag is left where the user can find it easily. It is important that the ceramic-glass cooktop be pretreated before use.

See *CARE AND CLEANING*.

INSTALLATION INSTRUCTIONS

TECHNICAL SPECIFICATIONS

LCE3010SB Radiant Cooktop

COOKTOP DIMENSIONS

Width	30-27/32" (783 mm)
Depth	21-15/32" (545mm)
Height	4" (101.6 mm)

COOKING ZONES

Position	Diameter	Power
Front Left	6" (152 mm)	1200 W
Front Right	9"/6" (229/152 mm)	3000/1400 W
Rear Left	8" (203mm)	1900 W
Rear Right	6" (152 mm)	100 W (Warm)
Center	7" (178 mm)	1500 W

COUNTERTOP CUTOUT DIMENSIONS

Width	29-3/8" (746 mm)
Depth	20-1/4" (515 mm)

ELECTRICAL SPECIFICATIONS

Connection voltage:
240/208 VAC 60 Hz.
32.1A/27.9 A

Maximum connected power load:
7700 W/5800 W

LCE3610SB Radiant Cooktop

COOKTOP DIMENSIONS

Width	36-11/16" (932 mm)
Depth	21-15/16" (557mm)
Height	4" (101.6 mm)

COOKING ZONES

Position	Diameter	Power
Front Left	6" (152mm)	1200 W
Front Right	9"/6" (229/152 mm)	3000/1400 W
Rear Left	8"/5" (203/127mm)	1900/950W
Rear Right	6" (152 mm)	100 W (Warm)
Center	12"/9"/6" (305/229/152 mm)	3000/2200/1100 W

COUNTERTOP CUTOUT DIMENSIONS

Width	34-9/16" (878 mm)
Depth	20-3/8" (517 mm)

ELECTRICAL SPECIFICATIONS

Connection voltage:
240/208 VAC 60 Hz.
38.3/33.2 A

Maximum connected power load:
9200/6900W

INSTALLATION INSTRUCTIONS

PREPARING THE INSTALLATION LOCATION

IMPORTANT INSTALLATION INFORMATION

- All electric cooktops run off a single phase, three-wire or four-wire cable, 240/208 volt, 60 hertz, AC-only electrical supply with ground.
- Minimum distance between cooktop and overhead cabinetry is 30" (762 mm).
- Make sure the cabinets and wall coverings around the cooktop can withstand the temperatures (up to 93°C [200°F]) generated by the cooktop.

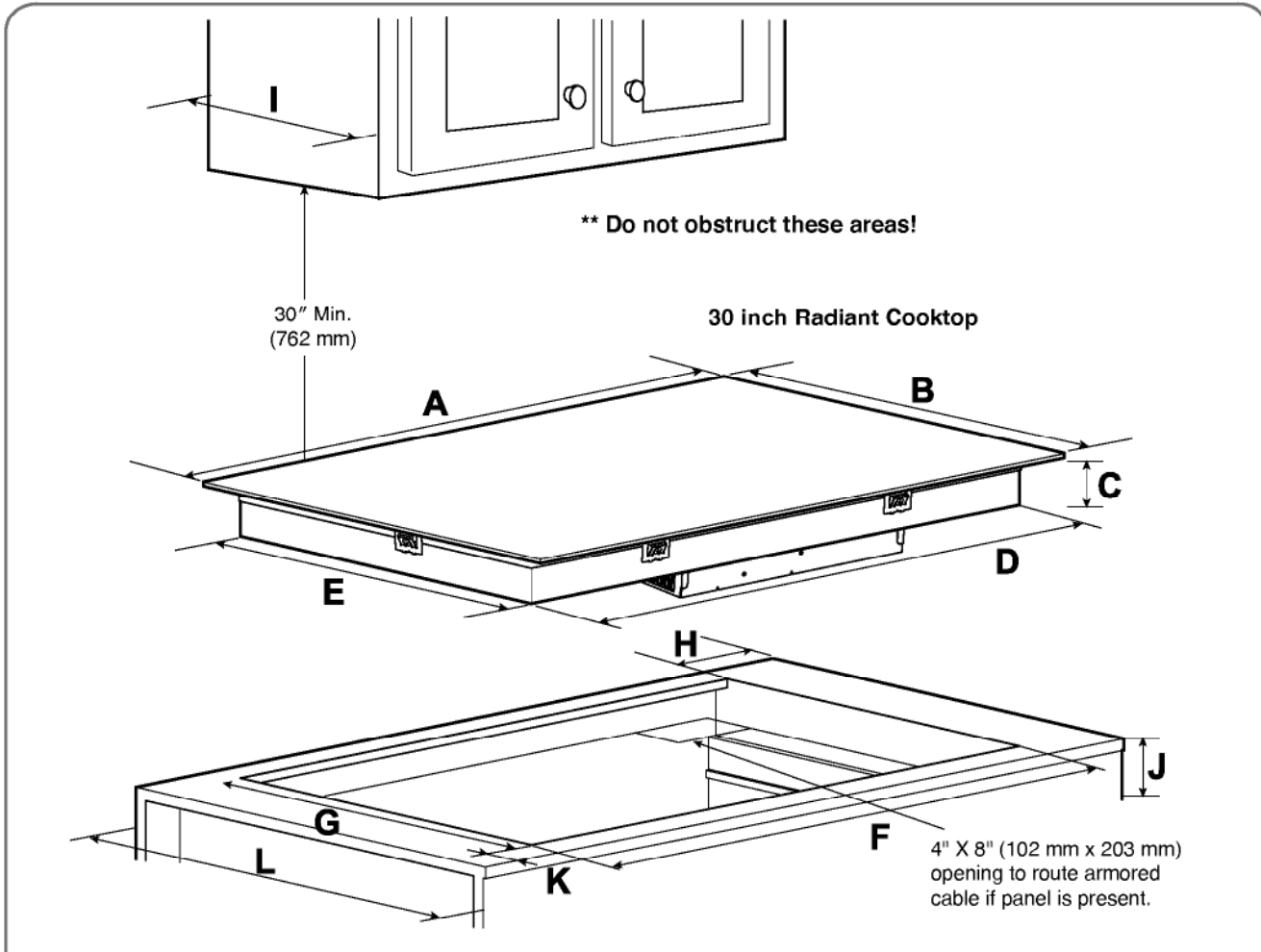

LCE3010SB Radiant Cooktop

Unit	A	B	C	D	E	F	G	H	I	J	K	L
						Min	Min		Max	Min		
Inch	30-27/32	21-15/32	3-3/4	28-13/16	19-5/8	29-3/8	20-1/4	13/16	13	5-23/32	2-1/2	24
mm	783	545	95	732	498	746	515	20	330	145	64	610

All dimensions are stated in inches and millimeters (mm).
 Allow 2" (50 mm) space below the armored cable opening to clear the electric cable and allow space for installation of the junction box on the wall at the back of the cooktop.

INSTALLATION INSTRUCTIONS

DIMENSIONS AND CLEARANCES

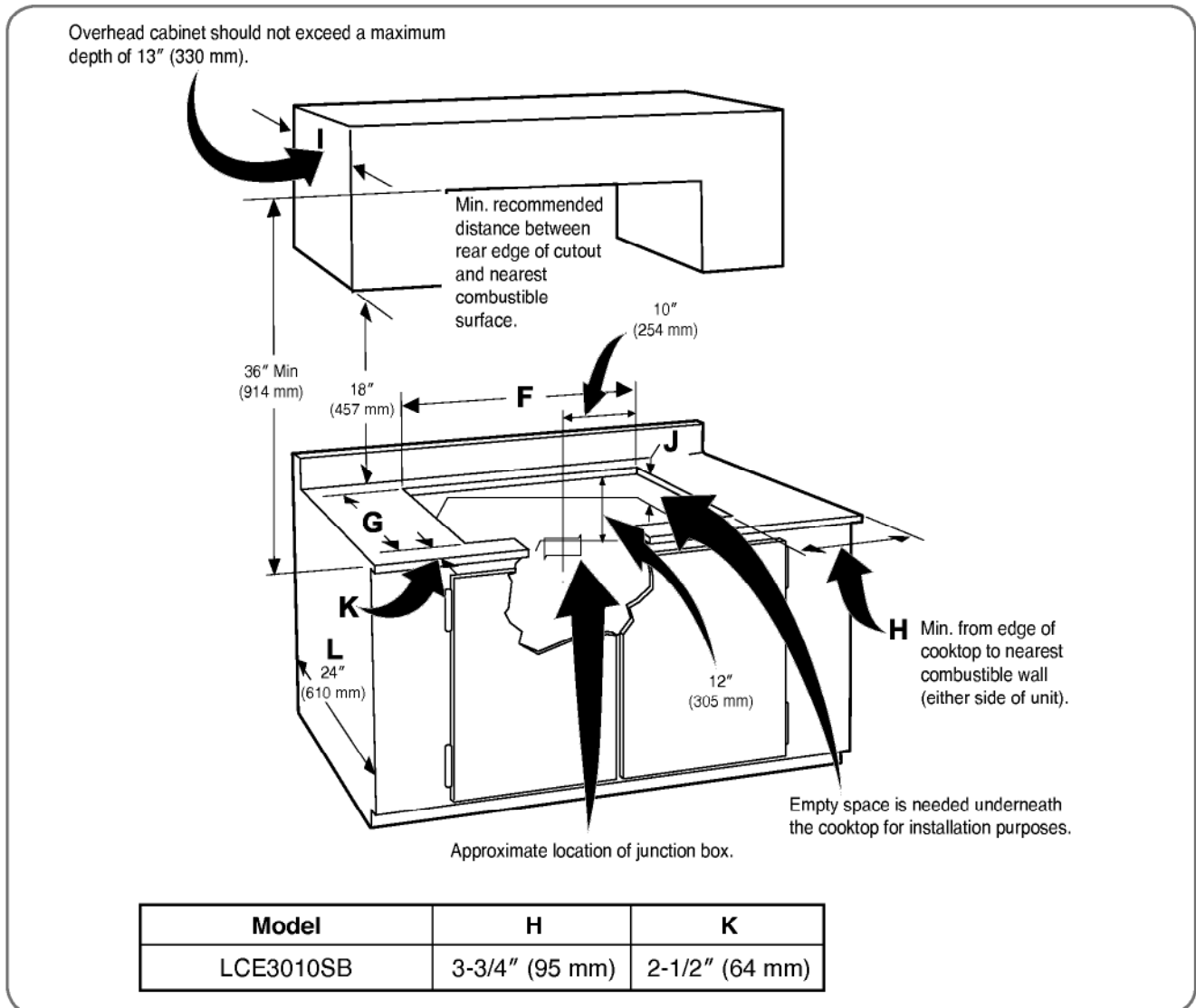

⚠ CAUTION

To eliminate the risk of burns or fire by reaching over heated surfaces, cabinet storage space located above the cooktop should be avoided. If cabinet storage is provided, risk can be reduced by installing a range hood that projects horizontally a minimum of 5" (127 mm) beyond the face of the cabinets.

INSTALLATION INSTRUCTIONS

PREPARING THE INSTALLATION LOCATION

IMPORTANT INSTALLATION INFORMATION

- All electric cooktops run off a single phase, three-wire or four-wire cable, 240/208 volt, 60 hertz, AC-only electrical supply with ground.
- Minimum distance between cooktop and overhead cabinetry is 30" (762 mm).
- Make sure the cabinets and wall coverings around the cooktop can withstand the temperatures (up to 93°C [200°F]) generated by the cooktop.

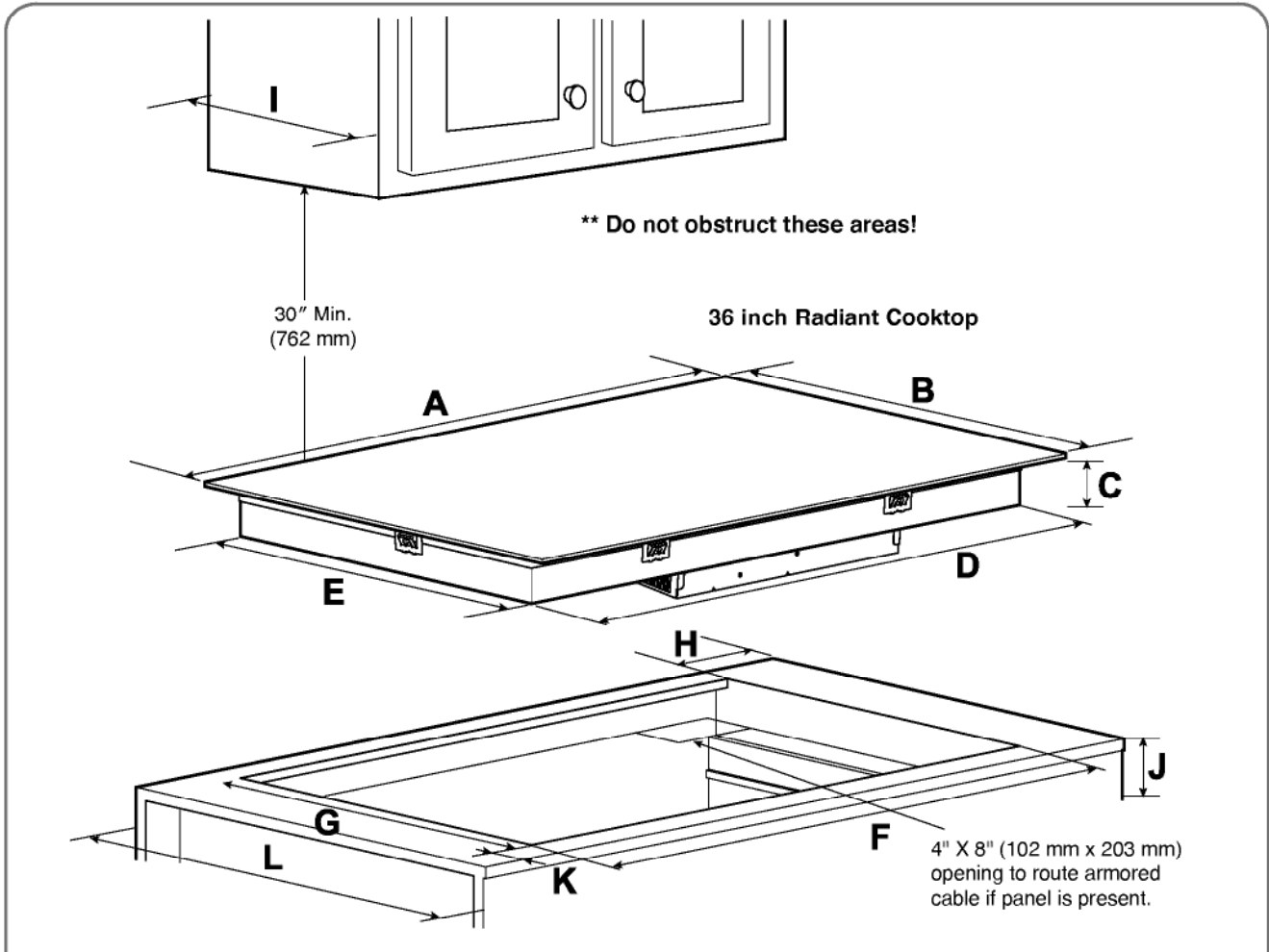

LCE3610SB Radiant Cooktop

Unit	A	B	C	D	E	F	G	H	I	J	K	L
						Min	Min		Max	Min		
Inch	36-11/16	21-15/16	3-3/4	33-27/32	19-25/32	34-9/16	20-3/8	13/16	13	5-23/32	2-1/2	24
mm	932	557	95	860	502	878	517	20	330	145	64	610

All dimensions are stated in inches and millimeters (mm).
 Allow 2" (50 mm) space below the armored cable opening to clear the electric cable and allow space for installation of the junction box on the wall at the back of the cooktop.

INSTALLATION INSTRUCTIONS

DIMENSIONS AND CLEARANCES

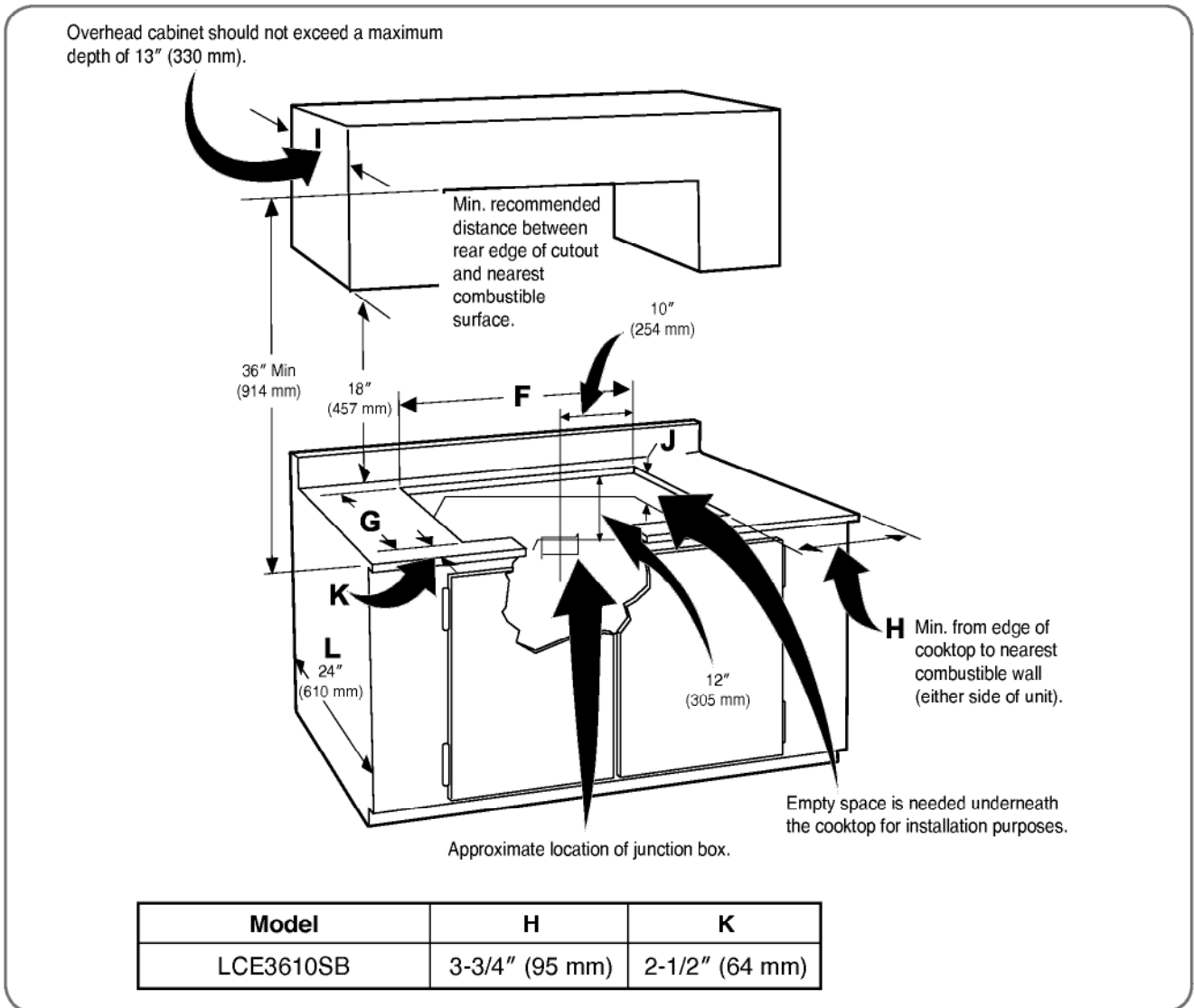

⚠ CAUTION

To eliminate the risk of burns or fire by reaching over heated surfaces, cabinet storage space located above the cooktop should be avoided. If cabinet storage is provided, risk can be reduced by installing a range hood that projects horizontally a minimum of 5" (127 mm) beyond the face of the cabinets.

INSTALLATION INSTRUCTIONS

ELECTRICAL CONNECTIONS

IMPORTANT SAFETY INSTRUCTIONS

- Be sure your cooktop is installed and grounded properly by a qualified installer or service technician.
- This cooktop must be electrically grounded in accordance with local codes or, in their absence, with the National Electrical Code ANSI/NFPA No. 70, latest edition in the United States.

WARNING

The electrical power to the cooktop must be shut off while line connections are being made. Failure to do so could result in serious injury or death.

PROVIDING THE ELECTRICAL CONNECTION

Install the junction box under the cabinet and run 120/240 or 120/208 volt, AC wire from the main circuit panel.

NOTE: DO NOT connect the wire to the circuit panel at this time.

ELECTRICAL REQUIREMENTS

Observe all governing codes and local ordinances.

- 1 A 3-wire or 4-wire single-phase 120/240 or 120/208 volt, 60 Hz AC-only electrical supply is required on a separate circuit fused on both sides of the line (time-delay fuse or circuit breaker is recommended). DO NOT fuse neutral. The fuse size must not exceed the circuit rating of the appliance specified on the nameplate.
- 2 36" Radiant cooktop can consume up to 9200W at 240 VAC. A 50 Amp circuit breaker with wire gauge #8 AWG must be used.
30" Radiant cooktop can consume up to 7700W at 240 VAC. A 40 Amp circuit breaker with wire gauge #8 AWG must be used.
NOTE: Wire sizes and connections must conform with the fuse size and rating of the appliance in accordance with the National Electrical Code ANSI/NFPA No. 70, latest edition, and local codes and ordinances.
- 3 The appliance should be connected to the fused disconnect (or circuit breaker) box through flexible armored or nonmetallic sheathed cable. The flexible armored cable extending from this appliance should be connected directly to the grounded junction box. The junction box should be located as shown on page 21 or 23 with as much slack as possible remaining in the cable between the box and the appliance, so it can be moved if servicing is ever necessary.
- 4 A suitable strain relief must be provided to attach the flexible armored cable to the junction box.

WARNING

An extension cord must not be used with this appliance. Such use may result in a fire, electrical shock, or other personal injury.

INSTALLATION INSTRUCTIONS

ELECTRICAL CONNECTIONS (cont.)

ELECTRICAL CONNECTION

Connect the flexible armored cable that extends from the surface unit to the junction box using a suitable strain relief at the point the armored cable enters the junction box. Then make the electrical connection as follows.

Electrical ground is required on this appliance.

This appliance is manufactured with a supply wire and a frame connected green or bare copper grounding wire.

NOTE TO ELECTRICIAN:

The armored cable leads supplied with the appliance are UL-listed for connection to larger gauge household wiring. The insulation of the leads is rated at temperatures much higher than the temperature rating of household wiring. The current-carrying capacity of the conductor wire is governed by the temperature rating of the insulation around the wire, rather than the wire gauge alone.

⚠ WARNING

DO NOT ground to a gas supply pipe. DO NOT connect to electrical power supply until appliance is permanently grounded. Connect the ground wire before turning on the power.

⚠ WARNING

This appliance is equipped with a copper conductor flexible cable. If connection is made to aluminum house wiring, use only special connectors which are approved for joining copper and aluminum wires in accordance with the National Electrical Code and local codes and ordinances. Improper connection of aluminum house wiring to copper leads can result in a short circuit or fire. Follow the connector manufacturer's recommended procedure closely.

WHERE LOCAL CODES PERMIT CONNECTING THE APPLIANCE-GROUNDING CONDUCTOR TO THE NEUTRAL (WHITE) WIRE

Observe all governing codes and local ordinances.

- 1 Disconnect the power supply.
- 2 At the circuit breaker box, fuse box or junction box, connect appliance and power supply cable wires as shown.

⚠ WARNING

You may not ground the cooktop through the neutral (white) wire if cooktop is used in a new branch circuit installation (1996 NEC), mobile home, recreational vehicle, or where local codes do not permit grounding to the neutral (white) wire. When grounding to the neutral (white) wire is prohibited, you must use a 4-wire power supply cable. Failure to heed this warning may result in electrocution or other serious personal injury.

3-WIRE GROUNDED JUNCTION BOX

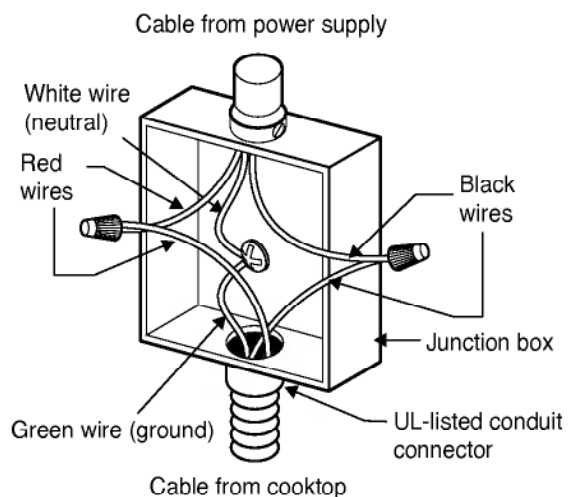

INSTALLATION INSTRUCTIONS

ELECTRICAL CONNECTIONS (cont.)

IF COOKTOP IS USED IN A NEW BRANCH CIRCUIT INSTALLATION (1996 NEC), MOBILE HOME, RECREATIONAL VEHICLE, OR WHERE LOCAL CODES DO NOT PERMIT GROUNDING TO THE NEUTRAL (WHITE) WIRE

Observe all governing codes and local ordinances.

- 1 Disconnect the power supply.
- 2 At the circuit breaker box, fuse box or junction box, connect appliance and power supply cable wires as shown.

⚠ WARNING

If connecting to a 4-wire power supply cable electrical system, the appliance frame connected ground wire **MUST NOT** be connected to the neutral wire of the 4-wire electrical system.

4-WIRE GROUNDED JUNCTION BOX

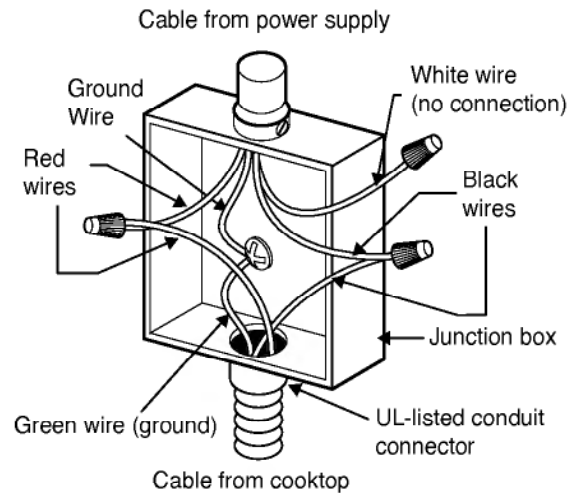

COOKTOP INSTALLATION

- 1 Visually inspect the cooktop for damage. Make sure all cooktop screws are tight (see below for locations).

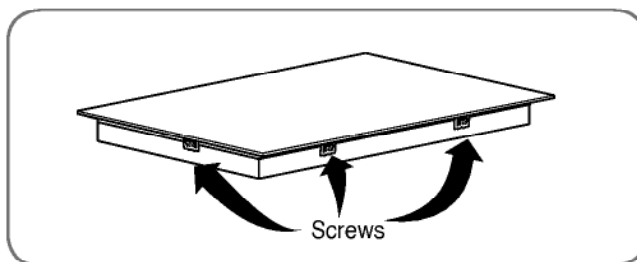

- 2 Carefully lower the cooktop into the counter-top cutout, making sure not to trap any wires. **NOTE:** Do not use caulking compound. The cooktop must be removable, should service be required.

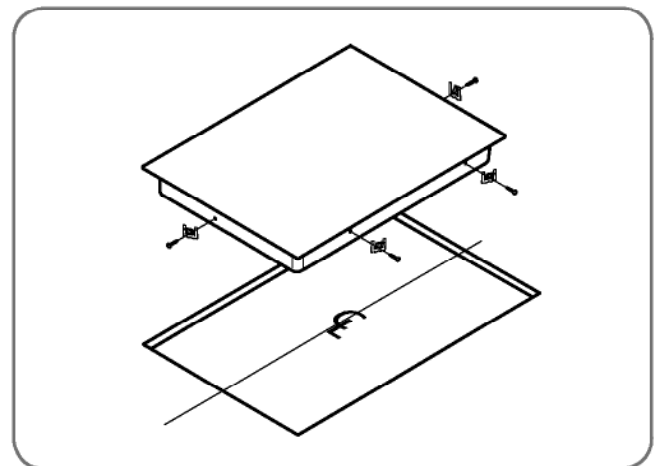

INSTALLATION INSTRUCTIONS

COOKTOP INSTALLATION (cont.)

- 3 Install the retainer brackets to the bottom of the cooktop; then snug the bolts against the bottom of the countertop as shown.

NOTE: The retainer brackets **MUST** be installed to meet local codes or, in their absence, with the National Electrical Code ANS/NFPA No. 70, latest edition.

LCE3010SB / LCE3610SB Radiant Cooktop

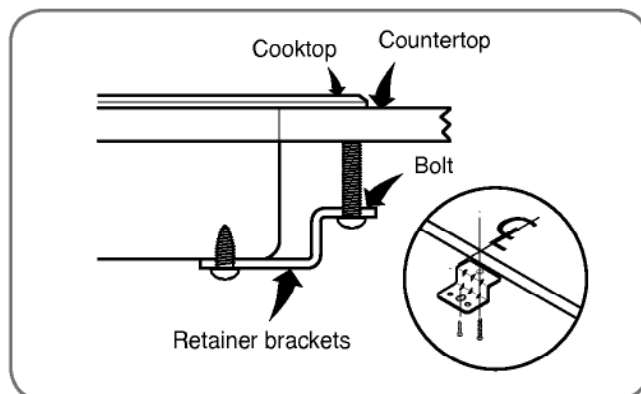
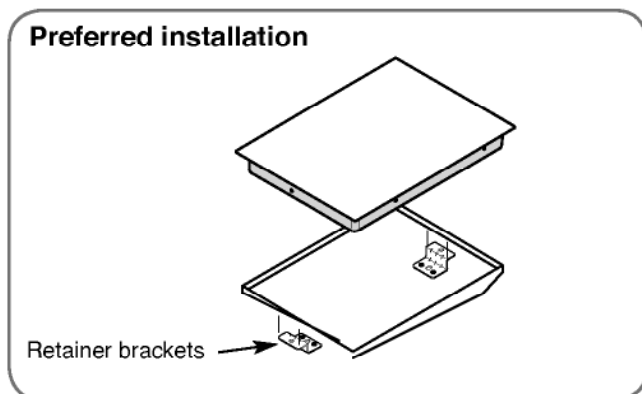

LCE3010SB Radiant Cooktop

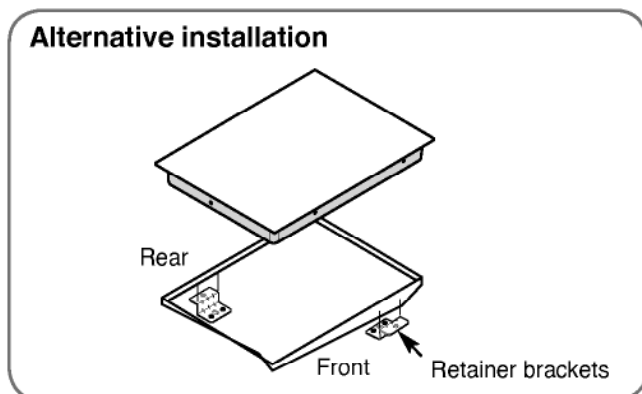

LCE3610SB Radiant Cooktop

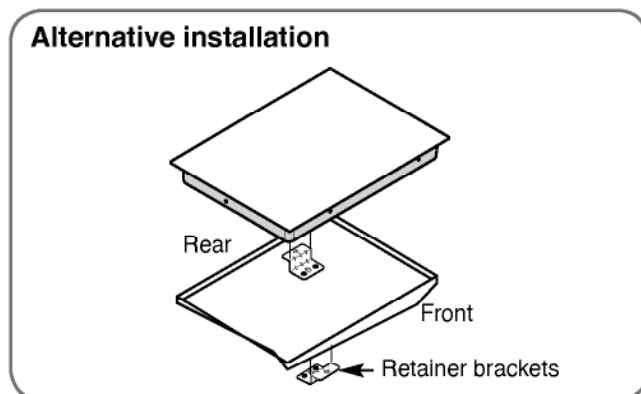

FINAL CHECK

Perform a final operational check of the cooktop, making sure the cooktop powers on properly and that each Cooking Zone operates correctly. Refer to the Operating Instructions in this guide for details.

MODEL AND SERIAL NUMBER LOCATION

The model and serial numbers are located on a plate on the bottom of the cooktop. Please record them in this guide; you will need them for warranty registration.

CAUTION
Do not touch cooktop glass or Cooking Zones. They may be hot enough to cause burns.







TROUBLESHOOTING

BEFORE CALLING FOR SERVICE

Before you call for service, review this list. It may save you time and expense. This list includes common occurrences that are not the result of a defect in workmanship or materials.

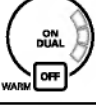
Problem	Possible Causes	Solutions
Cooktop does not work	<ul style="list-style-type: none">• Cooktop controls are locked.• Circuit breaker has tripped or fuse is blown.• Power outage.• Installation wiring not complete.	<ul style="list-style-type: none">• See USING CHILD LOCK to turn off the CHILD LOCK feature.• Reset the circuit breaker.• Check house lights to confirm power outage.• Contact the installer or dealer.
Cooktop does not heat	<ul style="list-style-type: none">• Incorrect Cooking Zone selected.• No power to cooktop.	<ul style="list-style-type: none">• Make sure the correct control is ON for the Cooking Zone being used.• See “Cooktop does not work” above.
Elements turns off while cooking.	<ul style="list-style-type: none">• Cooktop inner temperature too High.	<ul style="list-style-type: none">• Check that cooktop has been installed According to the installation instructions.
Elements do not get hot enough.	<ul style="list-style-type: none">• Touch controls may not be set properly.• Cookware may not be shape or flat or the correct size.	<ul style="list-style-type: none">• Check the power level.• Use the recommended cookware. See the page 8-9.
A fan sound can be heard.	<ul style="list-style-type: none">• Cooktop inner temperature is High.	<ul style="list-style-type: none">• This is normal. The cooling fan will run when any element is turned on. With the heavy use the fan may continue to run after the controls are turned off until the cooktop has cooled.

BEFORE CALLING FOR SERVICE

Problem	Possible Causes	Solutions
Flashing 	<ul style="list-style-type: none"> • There is a fault with thermistor or Micom. 	<ul style="list-style-type: none"> • Turn the cooktop off using the Power ON/OFF. Turn cooktop back on using the Power ON/OFF.
Flashing 		
Flashing 		
Flashing 	<ul style="list-style-type: none"> • Food spill/soil on touchpads. • Object placed on touchpad. • Touch time is long. 	<ul style="list-style-type: none"> • Clean the surface. • Remove object from the touch pad. • If any one of the keys is touched for more than 10 seconds continuously, this error will be displayed. • If water or a metal object is placed on the touchpad this error will be displayed. • Turn the cooktop off using the Power ON/OFF. Turn cooktop back on using the Power ON/OFF.
Flashing 	<ul style="list-style-type: none"> • There is a fault with Display. 	<ul style="list-style-type: none"> • Turn the cooktop off using the Power ON/OFF. Turn cooktop back on using the Power ON/OFF.
Flashing 	<ul style="list-style-type: none"> • Low voltage detection 	<ul style="list-style-type: none"> • This represents low voltage to the cooktop. Call a licensed electrician.

LG ELECTRONICS, INC. LG RADIANT COOKTOP LIMITED WARRANTY - USA

LG Electronics Inc. will repair or replace your product, at LG's option, if it proves to be defective in material or workmanship under normal use, during the warranty period set forth below, effective from the date of original consumer purchase of the product. This limited warranty is good only to the original purchaser of the product and effective only when used in U.S.A.

WARRANTY PERIOD:	WHAT IS COVERED:
One year from date of original purchase	Any part of the cooktop which fails due to a defect in materials or workmanship. During this full one-year warranty , LG will also provide, free of charge , all labor and in-home service to replace the defective part.
Please retain dealer's dated bill of sale as evidence of the Date of Purchase for proof of warranty, and submit a copy of the bill of sale to the service person at the time warranty service is provided. Please call 1-800-243-0000 and choose the appropriate option to locate your nearest LG Authorized Service Center. Or visit our Web site at http://us.lgservice.com .	

THIS WARRANTY IS IN LIEU OF ANY OTHER WARRANTIES, EXPRESS OR IMPLIED, INCLUDING WITHOUT LIMITATION, ANY WARRANTY OF MERCHANTABILITY OR FITNESS FOR A PARTICULAR PURPOSE. TO THE EXTENT ANY IMPLIED WARRANTY IS REQUIRED BY LAW, IT IS LIMITED IN DURATION TO THE EXPRESS WARRANTY PERIOD ABOVE. LG WILL NOT BE LIABLE FOR ANY CONSEQUENTIAL, INDIRECT, OR INCIDENTAL DAMAGES OF ANY KIND, INCLUDING LOST REVENUES OR PROFITS, IN CONNECTION WITH THE PRODUCT. SOME STATES DO NOT ALLOW LIMITATION ON HOW LONG AN IMPLIED WARRANTY LASTS OR THE EXCLUSION OF INCIDENTAL OR CONSEQUENTIAL DAMAGES, SO THE ABOVE LIMITATIONS OR EXCLUSIONS MAY NOT APPLY TO YOU.

THIS LIMITED WARRANTY DOES NOT APPLY TO:

1. Service calls to correct the installation of your appliance, to instruct you how to use your appliance, to replace house fuses or correct house wiring, or to replace owner-accessible light bulbs.
2. Repairs when your appliance is used in other than normal, single-family household use.
3. Pickup and delivery. Your appliance is designed to be repairable in the home.
4. Damage resulting from accident, alteration, misuse, abuse, fire, flood, improper installation, acts of God, or use of products not approved by LG Corporation.
5. Repairs to parts or systems resulting from unauthorized modifications made to the appliance.
6. Replacement parts or repair labor costs for units operated outside the United States.
7. Any labor costs during the limited warranty period.

This warranty is extended to the original purchaser for products purchased for home use within the USA. In Alaska, the warranty excludes the cost of shipping or service calls to your home. Some states do not allow the exclusion or limitation of incidental or consequential damages, so this exclusion or limitation may not apply to you. This warranty gives you specific legal rights, and you may also have other rights which vary from state to state. To know what your legal rights are, consult your local or state consumer affairs or your state's Attorney General.

TO CONTACT LG ELECTRONICS BY MAIL:

LG Customer Interactive Center
 P. O. Box 240007
 201 James Record Road
 Huntsville, Alabama 35824
 ATTN: CIC

LG ELECTRONICS, INC.
LG RADIANT COOKTOP LIMITED WARRANTY - CANADA

LG Electronics Inc. will repair or replace your product, at LG's option, if it proves to be defective in material or workmanship under normal use, during the warranty period set forth below, effective from the date of original consumer purchase of the product. This limited warranty is good only to the original purchaser of the product and effective only when used in Canada.

WARRANTY PERIOD:	WHAT IS COVERED:
One year from date of original purchase	Any part of the cooktop which fails due to a defect in materials or workmanship. During this full one-year warranty , LG will also provide, free of charge , all labor and in-home service to replace the defective part.
<p>Please retain dealer's dated bill of sale as evidence of the Date of Purchase for proof of warranty, and submit a copy of the bill of sale to the service person at the time warranty service is provided. This warranty is invalid if the factory-applied serial number has been altered or removed from the product.</p> <p>Please call 1-888-LG-CANADA (542-2623) and choose the appropriate option to locate your nearest LG Authorized Service Center or to obtain product or customer service assistance. Or visit our Web site at http://ca.lge.com. Have your product model, serial numbers and your postal code ready.</p>	

THIS WARRANTY IS IN LIEU OF ANY OTHER WARRANTIES, EXPRESS OR IMPLIED, INCLUDING WITHOUT LIMITATION, ANY WARRANTY OF MERCHANTABILITY OR FITNESS FOR A PARTICULAR PURPOSE. TO THE EXTENT ANY IMPLIED WARRANTY IS REQUIRED BY LAW, IT IS LIMITED IN DURATION TO THE EXPRESS WARRANTY PERIOD ABOVE. LG WILL NOT BE LIABLE FOR ANY CONSEQUENTIAL, INDIRECT, OR INCIDENTAL DAMAGES OF ANY KIND, INCLUDING LOST REVENUES OR PROFITS, IN CONNECTION WITH THE PRODUCT. SOME PROVINCES DO NOT ALLOW LIMITATION ON HOW LONG AN IMPLIED WARRANTY LASTS OR THE EXCLUSION OF INCIDENTAL OR CONSEQUENTIAL DAMAGES, SO THE ABOVE LIMITATIONS OR EXCLUSIONS MAY NOT APPLY TO YOU.

THIS LIMITED WARRANTY DOES NOT APPLY TO:

1. Service calls to correct the installation of your appliance, to instruct you how to use your appliance, to replace house fuses or correct house wiring, or to replace owner-accessible light bulbs.
2. Repairs when your appliance is used in other than normal, single-family household use.
3. Pickup and delivery. Your appliance is designed to be repairable in the home.
4. Damage resulting from accident, alteration, misuse, abuse, fire, flood, improper installation, acts of God, or use of products not approved by LG Corporation.
5. Repairs to parts or systems resulting from unauthorized modifications made to the appliance.
6. Replacement parts or repair labor costs for units operated outside the United States.
7. Any labor costs during the limited warranty period.

This warranty is extended to the original purchaser for products purchased for home use within Canada. Some provinces do not allow the exclusion or limitation of incidental or consequential damages, so this exclusion or limitation may not apply to you. This warranty gives you specific legal rights, and you may also have other rights which vary from province to province. To know what your legal rights are, consult your local or province consumer affairs or your province's Solicitor General.

TO CONTACT LG ELECTRONICS BY MAIL:

LG Customer Interactive Center
 550, boul. Matheson Est
 Mississauga (Ontario)
 L4Z 4G3

MEMO



LG Customer Information Center

1-800-243-0000 USA, Consumer User
1-888-865-3026 USA, Commercial User
1-888-542-2623 CANADA

Register your product Online!

www.lg.com