

This Owner's Manual is provided and hosted by [Appliance Factory Parts](#).



LG LSNK1830HM Owner's Manual

[Shop genuine replacement parts for LG LSNK1830HM](#)

3. Indoor Unit(18K, 24K)

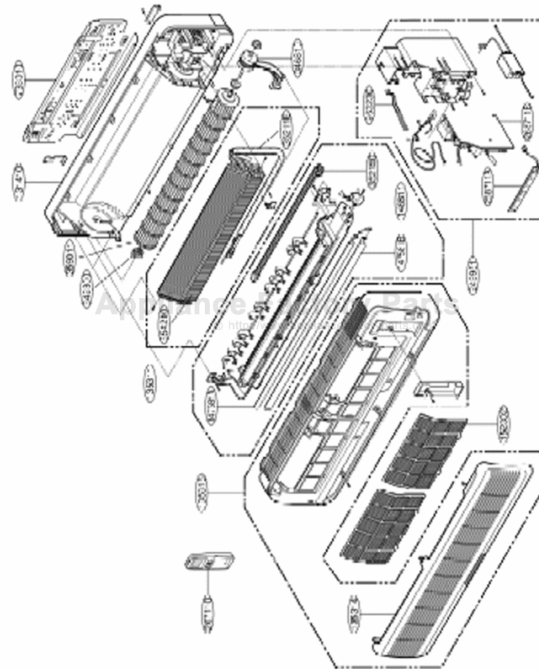

Copyright © 2010 LG ELECTRONICS, INC. All rights reserved.
Only for training and service purposes.

• 62 •

LG® Internal Use Only

[Find Your LG Air Conditioner Parts - Select From 2328 Models](#)

----- Manual continues below -----

HEAT CONTROLLER, INC.

ENERGY  **KNIGHT**®

**Wall Mounted Single-Zone
Mini-Split System Single-Zone
Air Conditioning / Heat Pump**

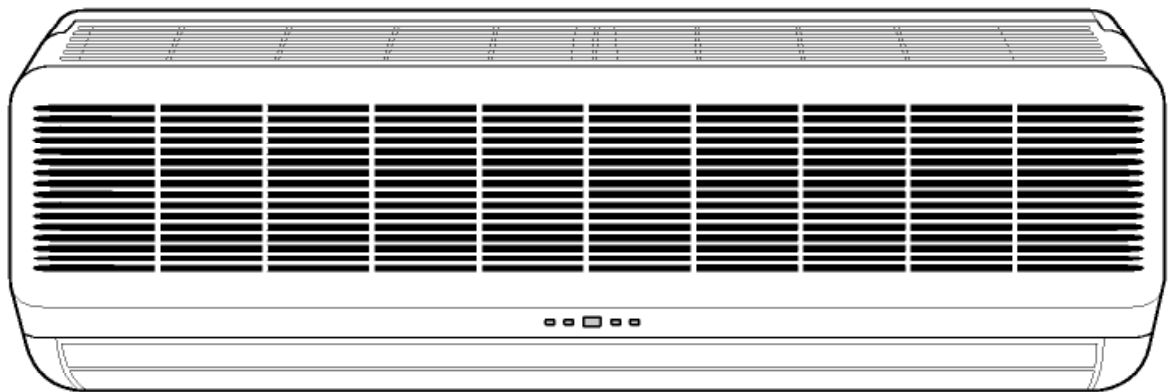

Owners Manual

Important Information

- Please read carefully and thoroughly this manual before operating this unit.
- Contact a qualified service technician for installation, repair and maintenance of this unit.
- The appliance is not intended for use by young children or those who require supervision.
- Young children should be supervised to ensure that they do not play with the appliance.

Safety Precautions

Warning2
 Caution3

Operating Instructions

Preparation before operation ..4
 Remote Control Features5
 Operation Mode Selection7
 Additional features12

Care and Maintenance

Care and Maintenance15
 When the air conditioner is not going to be used for a long time..17
 Operation Tips17

Troubleshooting tips

Before You Call For Service18

Safety precautions

To prevent injury to the user or other people and property damage, the following instructions must be followed.

■ Incorrect operation due to ignoring of instruction will cause harm or damage, the seriousness is classified by the following indications.

WARNING

This symbol indicates the possibility of death or serious injury.

CAUTION

This symbol indicates the possibility of injury or damage to properties only.

Installation precautions

WARNING

- **Do not install, remove and reinstall the unit by yourself.**
 - Improper installation will cause water leakage, electrical shock, or fire. Please consult authorized dealer or specialist for the installation work. Please note fault caused by improper installation is not covered by warranty.
 - Unit must be installed in an easily accessible area. Any additional cost required to hire a special equipment to service the unit will be the responsibility of the customer.

WARNING

Do not damage or use an unspecified power cord.

- It will cause electrical shock or fire.
- If the supply cord is damaged, it must be replaced by a special cord or assembly available from the manufacturer or its service agent.

Do not modify power cord length or share the outlet with other appliances.

- It will cause electrical shock or fire due to heat generation.

Do not operate with wet hand.

- It may cause electrical shock.

Do not insert anything into the air inlet/air outlet.

- Since the fan rotates at high speed, this may cause an injury or damage the unit.

Do not expose the skin directly to cool air for long periods of time.

- This could damage your health.

When an abnormality (smell of burning, etc) occurs, stop the air conditioner, and disconnect the power plug or turn off the breaker.

- If the unit continues to be operated in an abnormal condition, it may cause a fire, damage, etc. In this case, consult your dealer.

Repair or relocation should not be done by the customer.

- If this is done incorrectly, it may cause a fire, electric shock, injury by dropping of the unit, water leakage, etc. Consult your dealer.



CAUTION

- Contact the authorized Service technician for repair or maintenance of this unit.
- Contact the installer for installation of this unit.
- The air conditioner is not intended for use by young children or infirm persons without supervision.
- Young children should be supervised to ensure that they do not play with the air conditioner.

CAUTION

When the air filter is to be removed, do not touch the metal parts of the indoor unit.

- It may cause an injury.
- Should be disconnected from supply

When the unit is to be cleaned, switch off, and turn off the circuit breaker.

- Since the fan rotates at high speed during operation, it may cause an injury.

Do not apply an insecticide or flammable spray.

- It may cause a fire or deformation of the cabinet.

Do not insert hands through vanes when the air conditioner is operating

- It will cause an injury by the rotating blower.

Do not use for special purposes.

- Do not use this air conditioner to preserve precision devices, food, animal, plants, and art objects.
It may cause deterioration of quality, etc.

Do not clean the air conditioner with water.

- Water may enter the unit and degrade the insulation. It may cause an electric shock.

Do not put a pet or house plant where it will be exposed to direct air flow.

- This could injure the pet or plant.

Do not put a stove, etc. where is exposed to direct air flow.

- It may affect combustion.

When the unit is not going to be used for a long time, turn off the circuit breaker.

- If not, dirt may collect and cause a fire.

Do not operate for a long time in high humidity, e.g. leaving a door or window open.

- In the cooling mode, if it is operated in a room with high humidity (80%RH or more) for a long time, water condensed in the air conditioner may drop and may wet and spoil furniture, etc.

Ventilate well when used together with a stove, etc.

- An oxygen shortage may occur.

Do not leave on installation stand which is damaged.

- The unit may drop or fall down and cause an injury.

Do not step on the indoor/outdoor unit and do not put anything on it.

- It may cause an injury through dropping or falling down.

Do not step onto an unstable bench when cleaning and/or maintaining the unit.

- It may cause an injury, etc. by falling down.

Preparation before operation

How to Insert the Batteries

- 1 Remove the battery cover by pulling it according to the arrow direction.
- 2 Insert new batteries making sure that the (+) and (-) of battery are installed correctly.
- 3 Reattach the cover by sliding it back into position.

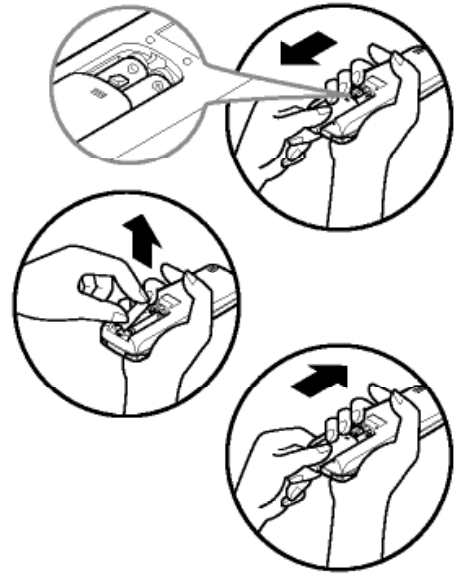

NOTES:

- Use 2 AAA(1.5volt) batteries. Do not use rechargeable batteries.

Storage and Tips For Using the Remote Control

- The remote control may be stored mounted on a wall.
- To operate the room air conditioner, aim the remote control at the signal receptor.
- The remote control will operate the air conditioner at a distance of up to 7m(23ft).

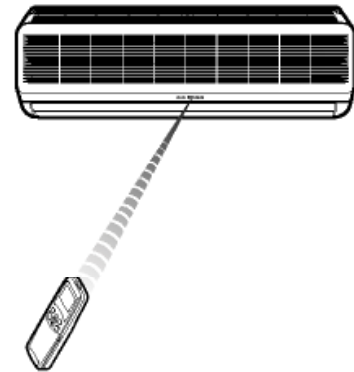
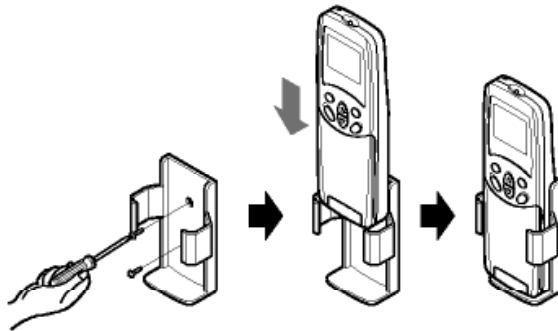

Signal Receptor

Receives the signals from the remote control. (Signal receiving sound: two short beeps or one long beep.)

Operation Indication Lamps

- | | | |
|-----------------|-------------------------------|---|
| | On/Off | : Lights up during the system operation. |
| | Sleep Mode | : Lights up during Sleep Mode Auto operation. |
| | Timer | : Lights up during Timer operation. |
| | Defrost Mode | : Lights up during Defrost Mode or Hot Start operation (Heat pump model only) |
| OUT DOOR | OUTDOOR UNIT OPERATION | : Lights up during outdoor unit operation. (Cooling model only) |

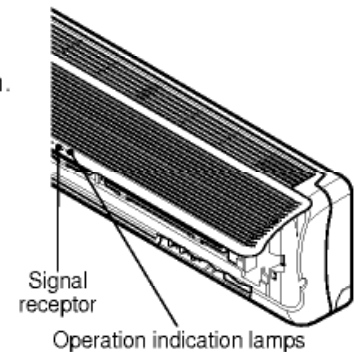

About the remote control on the system

The remote control transmits the signals to the system.



Features of the Remote Control- Door Closed

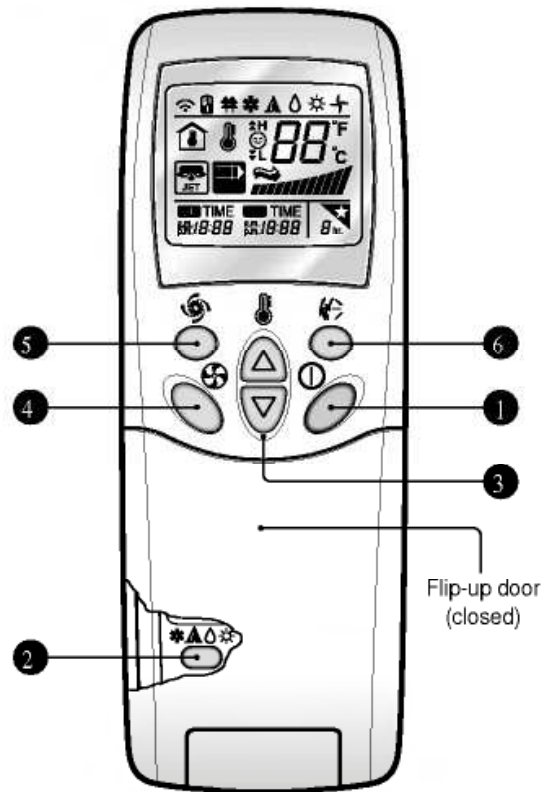

- 1 START/STOP BUTTON**
 Operation starts when this button is pressed and stops when the button is pressed again.
- 2 OPERATION MODE SELECTION BUTTON**
 Used to select the operation mode.
- 3 ROOM TEMPERATURE SETTING BUTTONS**
 Used to select the room temperature.
- 4 INDOOR FAN SPEED SELECTOR**
 Used to select fan speed in four steps low, medium, high, or CHAOS.
- 5 JET COOL**
 Used to start or stop the speed cooling. (Speed cooling operates super high fan speed in cooling mode.)
- 6 CHAOS SWING BUTTON**
 Used to stop or start louver movement and set the desired up/down airflow direction.

Safety Precautions

Operating Instructions

Care and Maintenance

Troubleshooting Tips

Operation Mode

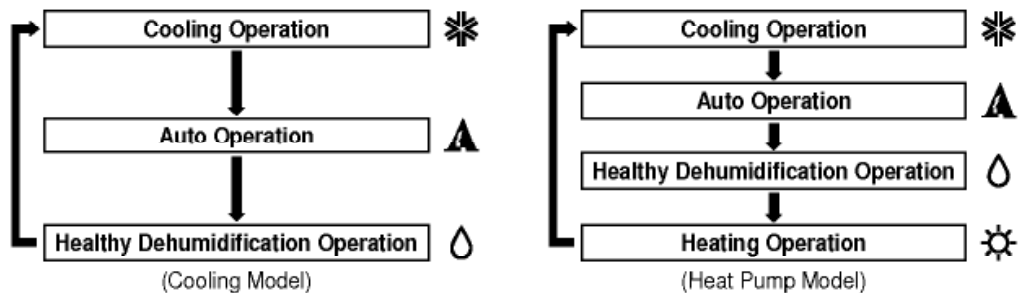



Features of the Remote Control- Door Opened

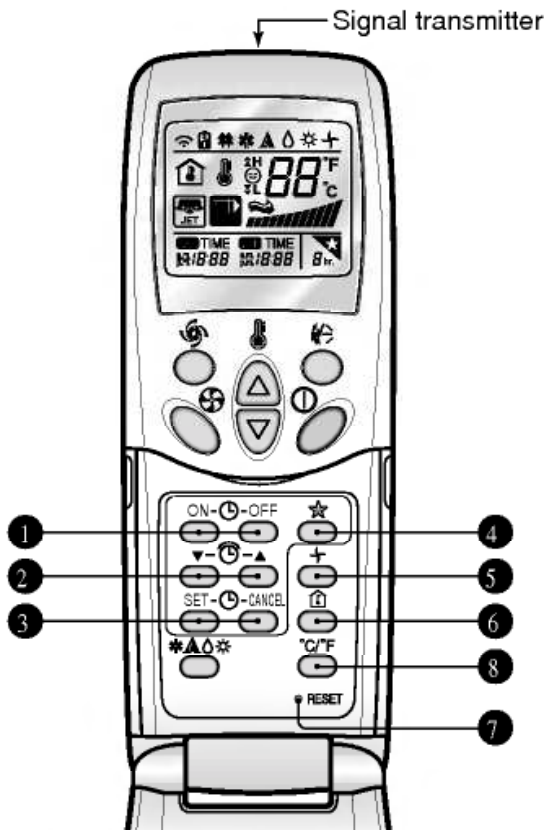

- 1 ON/OFF TIMER BUTTON**
Used to set the time of starting and stopping operation.
- 2 TIME SETTING BUTTONS**
Used to adjust the time. (See page 12)
- 3 TIMER SET/CANCEL BUTTONS**
Used to set the timer when the desired time is obtained and to cancel the Timer operation. (See page 12)
- 4 SLEEP MODE AUTO BUTTON**
Used to set Sleep Mode Auto operation. (See page 12)
- 5 AIR CIRCULATION BUTTON**
Used to circulate the room air without cooling or heating (turns indoor fan on/off). (See page 13)
- 6 ROOM TEMPERATURE CHECKING BUTTON**
Used to check the room temperature.
- 7 RESET BUTTON**
Used prior to resetting time or after replacing batteries.
- 8 °C TO °F SWITCHING BUTTON**
Used to switch temperature reading from Centigrade to Fahrenheit.

How to use the Operation Mode Selection button



Cooling Operation

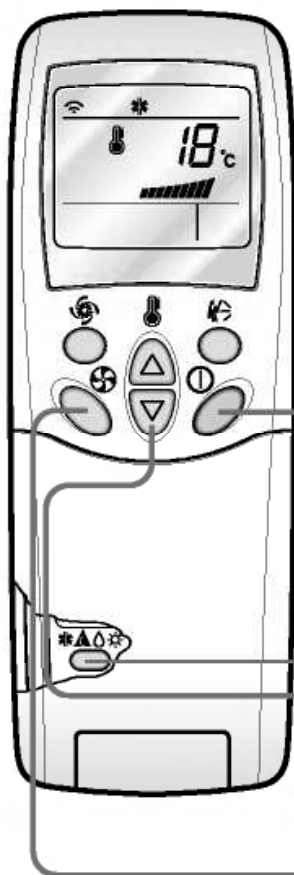

- 1 Press the Start/Stop button. The unit will respond with a beep.



- 2 Open the door on the remote control. To select **Cooling Operation**, press the Operation Mode Selection button. Each time the button is pressed, the operation mode is shifted in the direction of the arrow.

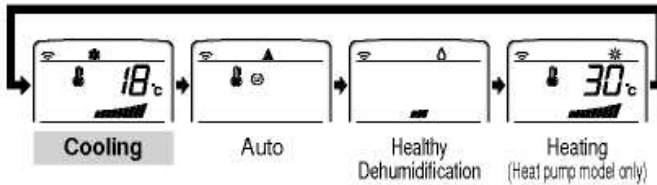

- 3 Close the door on the remote control. Set the temperature lower than the room temperature. The temperature can be set within a range of 18°C~30°C (64°F~86°F) in 1°C (2°F) increments.

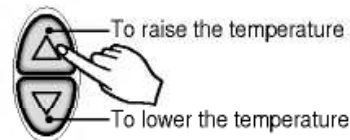

- 4 Set the fan speed again with the door of the remote control still closed. You can select the fan speed in four steps—low, medium, high, or CHAOS. Each time the button is pressed, the fan speed mode is shifted.



Natural wind by the CHAOS logic

- For more fresh feeling than other fan speed, press the Indoor Fan Speed Selector and set to CHAOS mode. In this mode, the wind blows like natural breeze by automatically changing fan speed according to the CHAOS logic.



Auto Operation

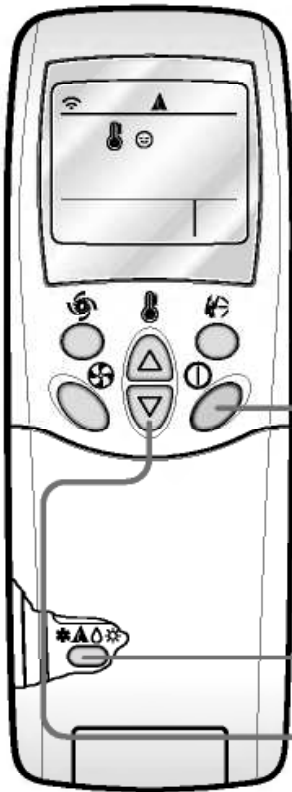

- 1 Press the Start/Stop button.
The unit will respond with a beep.



- 2 Open the door on the remote control. To select **Auto Operation**, press the Operation Mode Selection button. Each time the button is pressed, the operation mode is shifted in the direction of the arrow.

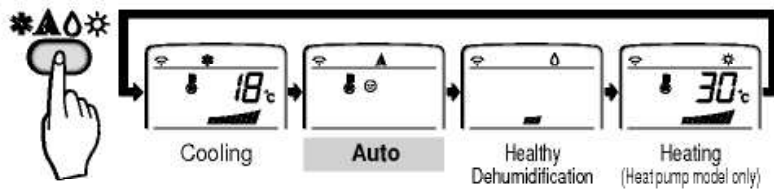

- 3 The temperature and fan speed are automatically set by the electronic controls based on the actual room temperature. If you want to change the set temperature, close the door on the remote control and press the Room Temperature Setting buttons. The cooler or warmer you feel, the more times (up to two times) you should press the button. The set temperature will then be changed automatically.

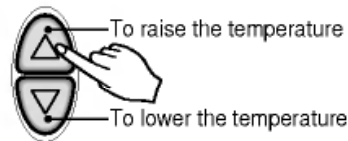

During Auto Operation:

- You cannot switch the indoor fan speed. It has already been set by the Fuzzy rule.
- If the system is not operating as desired, manually switch to another mode. The system will not automatically switch from the cooling mode to the heating mode, or from heating to cooling, it must be done by manually resetting.
- During Auto Operation, pressing the chaos swing button makes the horizontal louvers swing up and down automatically. If you want to stop auto-swing, press the chaos swing button again.



Healthy Dehumidification Operation

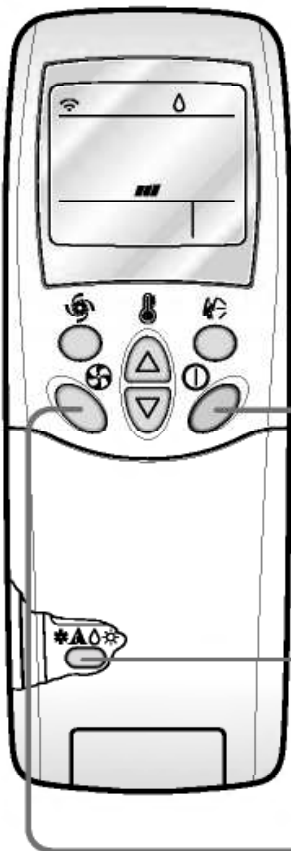

- 1 Press the Start/Stop button.
The unit will respond with a beep.



- 2 Open the door on the remote control. To select **Healthy Dehumidification Operation**, press the Operation Mode Selection button.
Each time the button is pressed, the operation mode is shifted in the direction of the arrow.

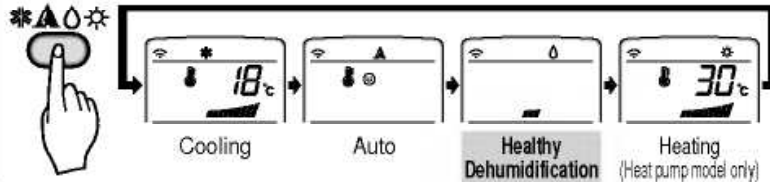

- 3 Set the fan speed again with the door of the remote control still closed. You can select the fan speed in four steps—low, medium, high, or CHAOS. Each time the button is pressed, the fan speed mode is shifted.



Natural wind by the CHAOS logic

- For more fresh feeling than other fan speed, press the Indoor Fan Speed Selector and set to CHAOS mode. In this mode, the wind blows like natural breeze by automatically changing fan speed according to the CHAOS logic.

During Healthy Dehumidification Operation:

- If you select the dehumidification mode on the operation selection button, the A/C starts to run the dehumidification function, automatically setting the room temp. and airflow volume to the best condition for dehumidification based on the sensed current room temp.

In this case, however, the setting temp. is not displayed in the remote control and you are not able to control the room temp. either.

- During the healthy dehumidification function, the airflow volume is automatically set according to the optimization algorithm responding to the current room temp. status and makes the room condition healthy and comfortable even in the high humidity season.



Heating Operation(Heat pump model only)

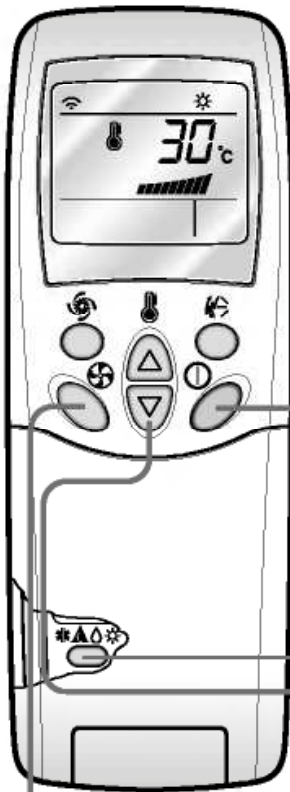

- 1 Press the Start/Stop button.
The unit will respond with a beep.



- 2 Open the door on the remote control. To select **Heating Operation**, press the Operation Mode Selection button. Each time the button is pressed, the operation mode is shifted in the direction of the arrow.

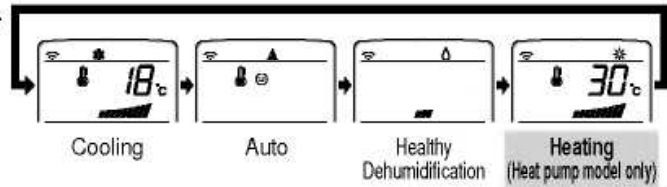

- 3 Close the door on the remote control.
Set the temperature higher than the room temperature.
The temperature can be set within a range of 16°C~30°C (60°F~86°F) in 1°C (2°F) increments.

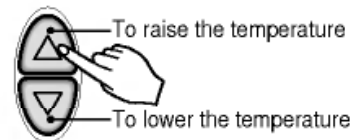

- 4 Set the fan speed again with the door of the remote control still closed. You can select the fan speed in four steps—low, medium, high, or CHAOS. Each time the button is pressed, the fan speed mode is shifted.



Natural wind by the CHAOS logic

- For more fresh feeling than other fan speed, press the Indoor Fan Speed Selector and set to CHAOS mode. In this mode, the wind blows like natural breeze by automatically changing fan speed according to the CHAOS logic.



Jet Cool Operation

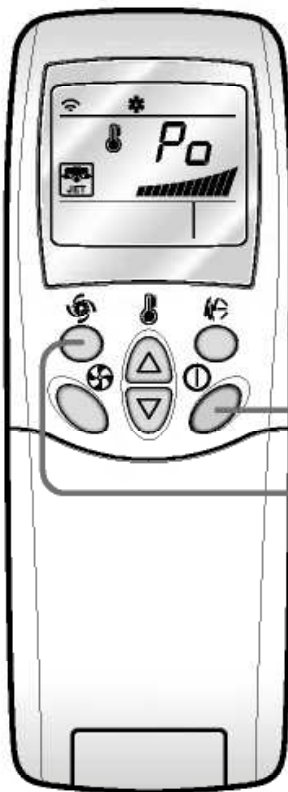

- 1 Press the Start/Stop button.
The unit will respond with a beep.



- 2 Press the **Jet Cool** button to operate the speed cooling mode and the unit will operate in super high fan speed on cooling mode for 30 minutes.



- 3 To cancel the **Jet Cool** mode, press the **Jet Cool** button again or the fan speed button or the room temperature setting button and the unit will operate in high fan speed on cooling mode.



NOTE:

- During the JET COOL function at any moment, the A/C starts to blow the cool air at extremely high speed for 30 minutes setting the room temp. automatically to 18°C. It is especially used to cool the room temp. in the shortest time in a hot summer.
In heat pump mode or neuro fuzzy mode however, the JET COOL function is not available.
- In order to return to the normal cooling mode from the JET COOL mode, you just press either the operation mode selection button, airflow volume selection or temp. setting button or the JET COOL button again.

Additional features



Sleep Mode

- 1 Press the Sleep Mode Auto button to set the time you want the unit to turn off automatically.
- 2 The Timer is programmed in one-hour increments by pressing the Sleep Mode Auto button 1 to 7 times. The sleep mode is available for 1 to 7 times. To alter the time period in steps of 1 hour, press the Sleep Mode Button while aiming at air conditioner.
- 3 Make sure the Sleep Mode Auto LED lights up.



To cancel the Sleep Mode, press the sleep Mode Auto button several times until the star (★) disappears from the operation display.

Note: The Sleep Mode will be operated at low fan speed (cooling) or medium fan speed (heat pump only) for quiet sleeping.

IN COOLING MODE: The temperature will automatically rise by 1°C over the next 30 minutes and by 2°C in 1 hour for comfortable sleeping.



Setting the Time

- 1 Time can be set only when you have pressed the Reset button. If you have just replaced the batteries, the Reset button should be pressed to reset the time.

Press the Start/Stop button.



- 2 Press the Time Setting buttons until the desired time is set.



- 3 Press the Timer SET button.



Note: Check the indicator for A.M. and P.M.



Delay Start/Pre-Set Stop

- 1 Make sure the time is set correctly on the remote control display.

- 2 Press the ON/OFF Timer buttons to turn Timer on or off.

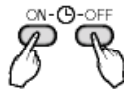

- 3 Press the Time Setting buttons until the desired time is set.



- 4 Press the selected on/off setting by pressing the Timer SET button while aiming the remote control at the signal receptor.



To cancel the setting the timer.



Press the Timer Cancel button while aiming remote control at the signal receptor.

(The timer lamp on the air conditioner and the display will go out.)

NOTE: Select one of the following four types of operation.

with the unit running



Delay OFF Timer



Delay ON Timer



Delay OFF and ON Timer



Delay ON and OFF Timer



Vertical Airflow Direction Control

The up/down airflow (Vertical Airflow) can be adjusted by using the remote control.



Press the Start/Stop button to start the unit.

Open the door on the remote control. Press Chaos Swing button and the louvers will swing up and down. Press the Chaos Swing button again to set the vertical louver at the desired airflow direction.



Note:

- ❑ If you press the CHAOS swing button, the horizontal airflow direction is changed automatically based on the CHAOS algorithm to distribute the air in the room evenly and at the same time to make the human body feel most comfortable, as if enjoying a natural breeze.
- ❑ Always use the remote control to adjust the up/down airflow direction. Manually moving the vertical airflow direction louver by hand could damage the air conditioner.
- ❑ When the unit is shut off, the up/down airflow direction louver will close the air outlet vent of the system.

To adjust left/right(Horizontal Airflow) direction

Caution: Ensure unit is turned off before adjusting the horizontal airflow direction control. Carefully open vertical louver to allow access to the horizontal airflow direction. Adjust the left/right airflow direction by hand.

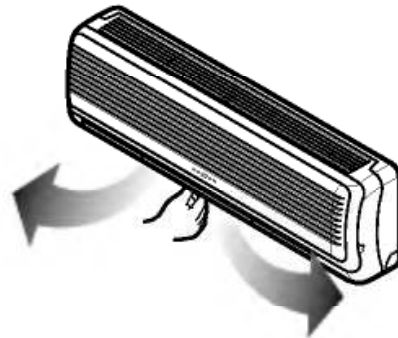

Air Circulation Mode

Circulates the room air without cooling or heating.

- 1 Press the Start/Stop button. the unit will respond with a beep.
- 2 Open the door on the remote control. Press the Air Circulation button. Close the door on the remote control. Now each time that you press the Indoor Fan Speed Selector, the fan speed is shifted from low to CHAOS and back to low again.

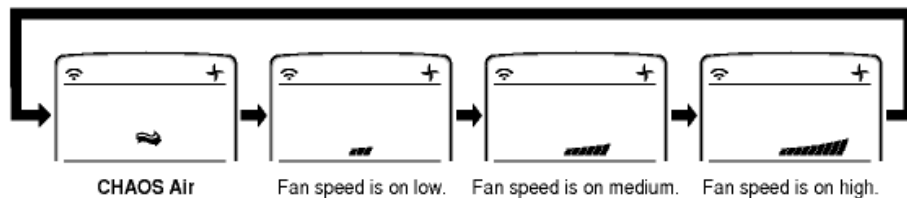

Note:

- ❑ **CHAOS Air** economizes power consumption and prevents overcooling. The fan speed is automatically changed from high to low or vice versa, depending on the ambient temperature.



Slide Switch Operation

FORCED OPERATION

Operation procedures when the remote control can't be used.

Open the front panel upward and move the Slide Switch to the Forced Operation position.

If you want to stop operation, move the Slide Switch to the Auto Restart or the Remote Control position.

In case the power comes on again after power failure on the Forced Operation position, the operating conditions are automatically set as follows:

During Forced Operation, the initial mode continues.

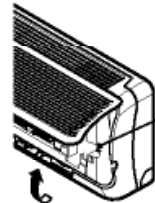

Open the front panel upward

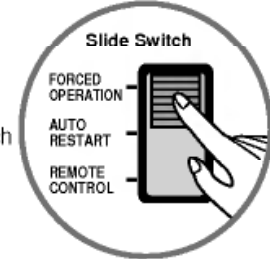

	Cooling Model	Heat pump Model		
		Room Temp. $\geq 24^{\circ}\text{C}(76^{\circ}\text{F})$	$21^{\circ}\text{C}(70^{\circ}\text{F}) \leq \text{Room Temp.} < 24^{\circ}\text{C}(76^{\circ}\text{F})$	Room Temp. $< 21^{\circ}\text{C}(70^{\circ}\text{F})$
Operating mode	Cooling	Cooling	Healthy Dehumidification	Heating
Indoor FAN Speed	High	High	Healthy Dehumidification Rule	High
Setting Temperature	$22^{\circ}\text{C}(72^{\circ}\text{F})$	$22^{\circ}\text{C}(72^{\circ}\text{F})$	$23^{\circ}\text{C}(74^{\circ}\text{F})$	$24^{\circ}\text{C}(76^{\circ}\text{F})$

Auto restart

In case the power comes on again after a power failure, Auto Restarting Operation is the function to operate procedures automatically to the previous operating conditions.

If you want to use this operation, Open the front panel upward and move the slide switch to the Auto Restart position.

If you do not want to use this operation, move the Slide Switch to the Remote Control position.

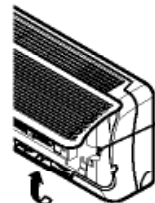

Open the front panel upward

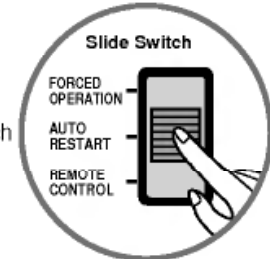

When you are out for a while, put the Slide Switch on the Remote Control.

Helpful information

Fan speed and cooling capacity.

The cooling capacity indicated in the specification is the value when the fan speed is set to high, and the capacity will be lower at low or medium fan speed.

High fan speed is recommended when you wish to cool the room quickly.

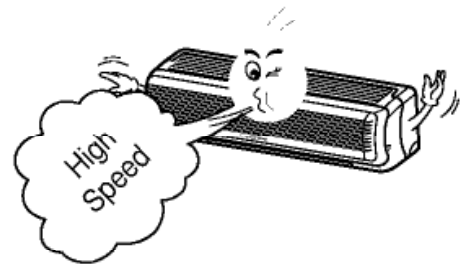

Care and maintenance of the air conditioner

CAUTION: Before performing any maintenance, turn off the main power to the system.

Indoor Unit

Grille, Case, and Remote Control

- Turn the system off before cleaning. To clean, wipe with a soft, dry cloth. Do not use bleach or abrasives.

NOTE:

Supply power must be disconnected before cleaning the indoor unit.

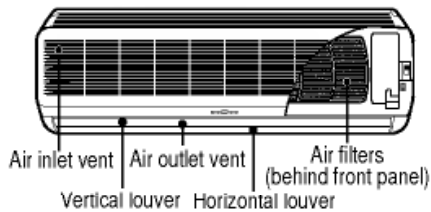

AIR FILTERS

The air filters behind the front grille should be checked and cleaned once every 2 weeks or more often if necessary.

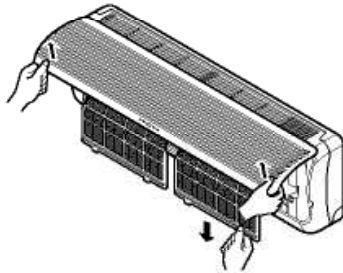

- Never use any of the followings:

- Water hotter than 40°C(104°F)
Could cause deformation and/or discoloration.
- Volatile substances
Could damage the surfaces of the air conditioner.



- 1 Lift the front access panel and pull the filter tab slightly forward to remove the filter.
- 2 Clean the filter with a vacuum or warm, soapy water.
 - If dirt is conspicuous, wash with a solution of detergent in lukewarm water.
 - If hot water (40°C(104°F) or more) is used, it may be deformed.
- 3 After washing with water, dry well in the shade.
- 4 Re-install the air filter.

Replacement of Purifying Filter(Optional)

• Recommended use period : About 2 years

- 1 Open front panel and remove air filters.

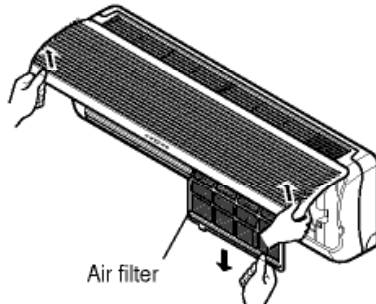

- 2 Remove air purifying filters.

- 3 Insert new air purifying filters.

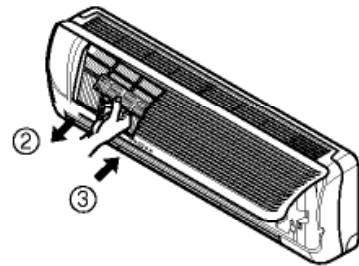

- 4 Reinsert air filters and close front panel.

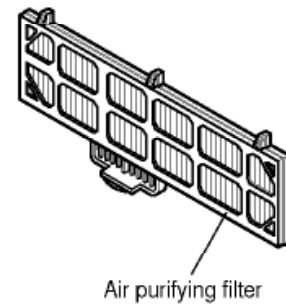
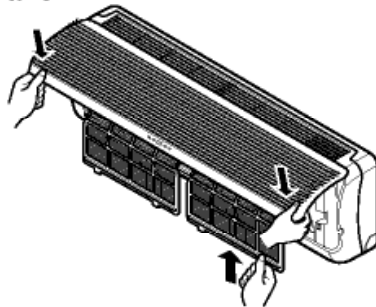

Outdoor Unit

The heat exchanger coils and panel vents of the outdoor unit should be checked regularly. If clogged with dirt or soot, the heat exchanger and panel vents may be professionally steam cleaned.

NOTE:

Dirty or clogged coils will reduce the operating efficiency of the system and cause higher operating costs.

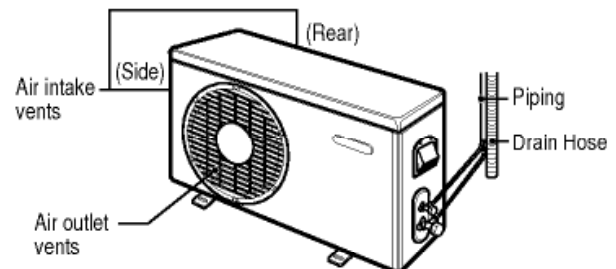

When the air conditioner is not going to be used for a long time.

When air conditioner is not going to be used for a long time.

- 1** Operate the air conditioner on Air circulation mode (Refer to page 13) for 2 to 3 hours.
 - This will dry out the internal mechanisms.
- 2** Turn off the circuit breaker, and disconnect the plug.



Turn off the circuit breaker when the air conditioner is not going to be used for a long time.
Dirt may collect and may cause a fire.

- 3** Remove the batteries from the remote control.

When the air conditioner is to be used again.

- 1** Clean the air filter and install it in the indoor unit.
(Refer to page 15 for cleaning filters.)
- 2** Check that the air inlet and outlet of the indoor/outdoor unit are not blocked.

Operation Tips

Do not overcool the room.

This is not good for the health and wastes electricity.

Make sure that the doors and windows are shut tight.

Avoid opening doors and windows as much as possible to keep the cool air in the room.

Keep blinds or curtains closed.

Do not let direct sunshine enter the room when the air conditioner is in operation.

Clean the air filter regularly.

Blockages in the air filter reduce the airflow and lower cooling and dehumidifying effects. Clean at least once every two weeks.

Keep the room temperature uniform.

Adjust the vertical and horizontal airflow direction to ensure a uniform temperature in the room.

Ventilate the room occasionally.

Since windows are kept closed, it is a good idea to open them and ventilate the room now and then.

Before you call for service...



Troubleshooting Tips! Save time and money!

Check the following points before requesting repairs or service.... If the fault persists, please contact your dealer or service center.

Case	Explanation	See page
The air conditioner does not operate.	• Have you made a mistake in timer operation?	12
	• Has the fuse blown or has the circuit breaker been tripped?	-
The room has a peculiar odor.	• Check that this is not a damp smell exuded by the walls, carpet, furniture, or cloth items in the room.	-
It seems that condensation is leaking from the air conditioner.	• Condensation occurs when the airflow from the air conditioner cools the warm room air.	-
Air conditioner does not operate for about 3 minutes when restarted.	• This is the protector of the mechanism. • Wait about three minutes and operation will begin.	-
Does not cool or heat effectively.	• Is the air filter dirty? See air filter cleaning instructions.	15
	• Has the temperature been set incorrectly?	7, 10
	• Are the indoor unit's air inlet or outlet vents obstructed?	-
The air conditioner operation is noisy.	• For a noise that sounds like water flowing. -This is the sound of freon flowing inside the air conditioner unit. • For a noise that sounds like the compressed air releasing into atmosphere. -This is the sound of the dehumidifying water being processed inside the air conditioning unit.	-
Remote control display is faint, or no display at all.	• Are the batteries depleted? • Are the batteries inserted in the opposite (+) and (-) directions?	4
Crack sound is heard.	• This sound is generated by the expansion/constriction of the front panel, etc. due to changes of temperature.	-

NOTE

WATER RESISTANT: The outdoor side of this appliance is WATER RESISTANT.

The indoor side is not water resistant and should not be exposed to excess water.

Specifications and performance data subject to change without notice.

HEAT CONTROLLER, INC.

1900 WELLWORTH AVENUE • JACKSON, MICHIGAN 49203

THE QUALITY LEADER IN CONDITIONING AIR

P/No.: 3828A20093F