



website <http://www.lgservice.com>

LG

# LG Room Air Conditioner

## ***OWNER'S MANUAL***

Prior to installation, this air-conditioning unit must be submitted for approval by the utility service which provides electricity (EN 61000-2, EN 61000-3 Norm).

ENGLISH

FRANÇAIS

ESPAÑOL

### **IMPORTANT**

- Please read this owner's manual carefully and thoroughly before installing and operating your room air conditioner.
- Please retain this owner's manual for future reference after reading it thoroughly.

# TABLE OF CONTENTS

Safety Precautions.....	3
Prior to Operation .....	9
Electrical Safety .....	10
Operating Instructions.....	11
Maintenance and Service .....	22



## FOR YOUR RECORDS

Write the model and serial numbers here:

Model # \_\_\_\_\_

Serial # \_\_\_\_\_

You can find them on a label on the side of each unit.

Dealer's Name \_\_\_\_\_

Date Purchased \_\_\_\_\_

■ Staple your receipt to this page in the event you need it to prove date of purchase or for warranty issues.



## READ THIS MANUAL

Inside you will find many helpful hints on how to use and maintain your air conditioner properly. Just a little preventive care on your part can save you a great deal of time and money over the life of your air conditioner.

You'll find many answers to common problems in the chart of troubleshooting tips. If you review our chart of **Troubleshooting Tips** first, you may not need to call for service at all.



## PRECAUTION

- Contact the authorized service technician for repair or maintenance of this unit.
- Contact the installer for installation of this unit.
- The air conditioner is not intended for use by young children or invalids without supervision.
- Young children should be supervised to ensure that they do not play with the air conditioner.
- When the power cord is to be replaced, replacement work shall be performed by authorized personnel only using only genuine replacement parts.
- Installation work must be performed in accordance with the National Electric Code by qualified and authorized personnel only.



# Safety Precautions

To prevent the injury of the user or other people and property damage, the following instructions must be followed.

- Incorrect operation due to ignoring instruction will cause harm or damage. The seriousness is classified by the following indications.

**▲ WARNING** This symbol indicates the possibility of death or serious injury.

**▲ CAUTION** This symbol indicates the possibility of injury or damage to properties only.

- The meanings of the symbols used in this manual are as shown below.

	<b>Be sure not to do.</b>
	<b>Be sure to follow the instruction.</b>

## ▲ WARNING

### ■ Installation

**Do not use damaged power cords, plugs, or a loose socket.**

- There is risk of fire or electric shock.



**For electrical work, contact the dealer, seller, a qualified electrician, or an Authorized Service Center.**

- There is risk of fire or electric shock.



**Always use the power plug and socket with the ground terminal.**

- There is risk of electric shock.

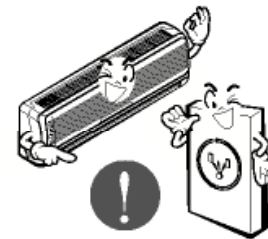

**Install the panel and the cover of control box securely.**

- There is risk of fire or electric shock.



**Do not modify or extend the power cord.**

- There is risk of fire or electric shock.

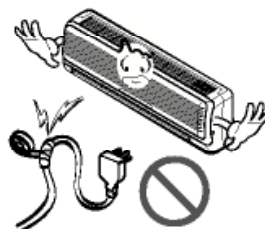

**Do not install, remove, or re-install the unit by yourself (customer).**

- There is risk of fire, electric shock, explosion or injury.



**Be cautious when unpacking and installing the product.**

- Shape edges could cause injury. Be especially careful of the sharp edges.



**For installation, always contact the dealer or an Authorized Service Center.**

- There is risk of fire, electric shock, explosion, or injury.

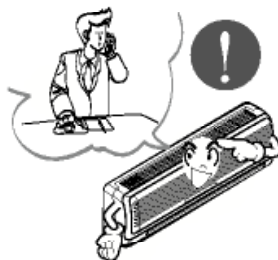

**Do not install the product on a defective installation stand.**

- It may cause injury, accident, or damage to the product.

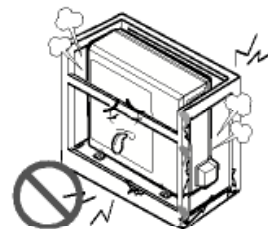

**Operation**

**Be sure the installation area does not deteriorate with age.**

- If the base collapses, the air conditioner could fall with it, causing property damage, product failure, and personal injury.

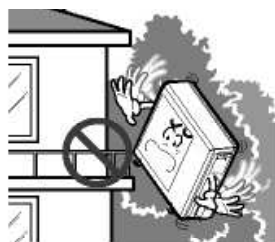

**Take care to ensure that power cords could not be pulled out or damaged during operation.**

- There is risk of fire or electric shock.

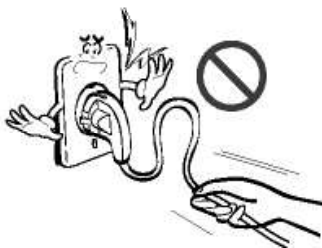

**Do not place anything on the power cord.**

- There is risk of fire or electric shock.



**Do not turn the air-conditioner ON or OFF by plugging or unplugging the power plug.**

- There is risk of fire or electric shock.



**Use a dedicated outlet for this appliance.**

- There is risk of fire or electric shock.

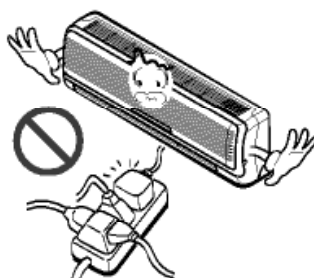

**Grasp the plug to remove the cord from the outlet. Do not touch it with wet hands.**

- There is risk of fire or electric shock.



**Do not place a heater or other appliances near the power cable.**

- There is risk of fire and electric shock.

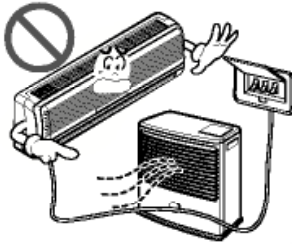

**Do not allow water to run into electric part.**

- It may cause There is risk of fire, failure of the product, of electric shock.



**Do not store of use flammable gas or combustibles near the air conditioner.**

- There is risk of fire or failure of product.



**Do not use the product in a tightly closed space for a long time.**

- Oxygen deficiency could occur.

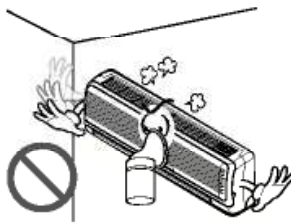

**When flammable gas leaks, turn off the gas and open a window for ventilation before turn the product on. Do not use the telephone or turn switches on or off.**

- There is risk of explosion or fire.

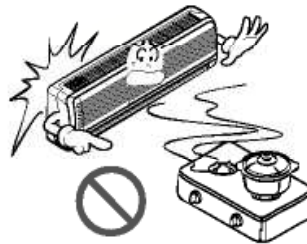

**Unplug the unit if strange sounds odors, or smoke comes from it.**

- There is risk of fire or electric shock.



**Stop operation and close the window in storm or hurricane. If possible, remove the air conditioner from the window before the hurricane arrives.**

- There is risk of property damage, failure of product, or electric shock.

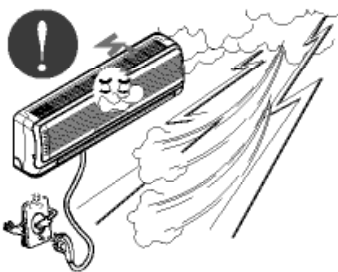

**Do not open the inlet grill of the product during operation. (Do not touch the electrostatic filter, if the unit is so equipped.)**

- There is risk of physical injury, electric shock, or product.



**When the product is soaked (flooded or submerged), contact an Authorized Service Center.**

- There is risk of electrical shock.



Ventilate the product from time to time when operating it together with a stove, etc.

- There is risk of fire or electrical shock.



Unplug the appliance before performing cleaning or maintenance.

- There is risk of electric shock.

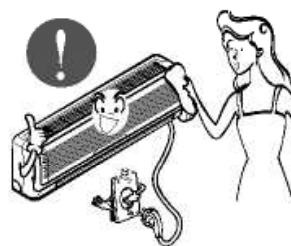

When the product is not be used for a long time disconnect the power supply plug or turn off the breaker.

- There is risk of product damage or failure, or unintended operation.

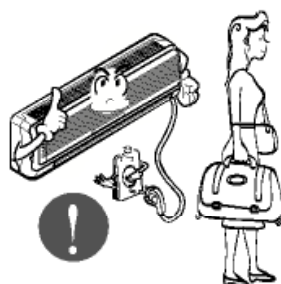

Take care to ensure that nobody could step on or fall onto the outdoor unit.

- There could result in personal injury and product damage.



## CAUTION

### Installation

Always check for gas(refrigerant) leakage after installation or repair of product.

- Low refrigerant levels may cause failure of product.

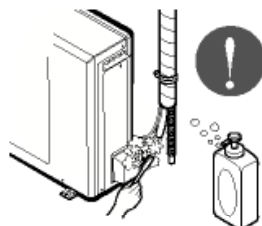

Install the drain hose to ensure that water is drained away properly.

- A bad connection may cause water leakage.

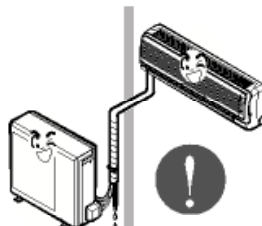

Keep level even when installing the product.

- To avoid vibration or water leakage.

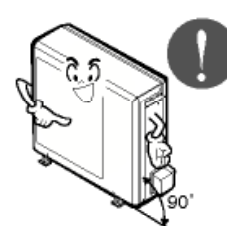

**Do not install the product where the noise or hot air from the outdoor unit could damage the neighborhoods.**

- It may cause a problem for your neighbors.



**Use two or more people to lift and transport the air conditioner**

- Avoid personal injury.



**Do not install the product where it will be exposed to sea wind (salt spray) directly.**

- It may cause corrosion in the product. Corrosion, particularly on the condenser and evaporator fins, could cause product malfunction or inefficient operation.

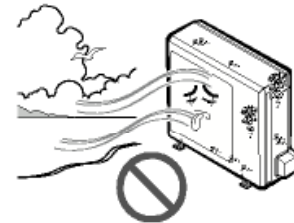

## ■ Operation

**Do not direct airflow at room occupants. (Don't sit in the draft.)**

- This could damage your health.



**Do not use the product for special purposes, such as preserving foods, works of art, etc. It is a consumer air conditioner, not a precision refrigeration system.**

- There is risk of damage or loss of property.

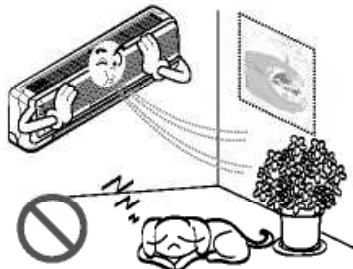

**Do not block the inlet or outlet of air flow.**

- It may cause product failure.

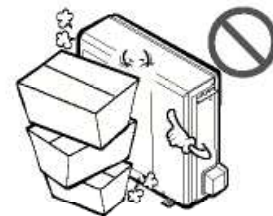

**Use a soft cloth to clean. Do not use harsh detergents, solvents, etc.**

- There is risk of fire, electric shock or damage to the plastic parts of the product.

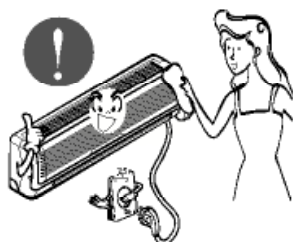

**Do not touch the metal parts of the product when removing the air filter. They are very sharp!**

- There is risk of personal injury.

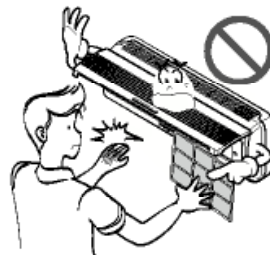

**Do not step on or put anything on the product. (outdoor unit)**

- There is risk of personal injury and failure of product.



**Always insert the filter securely. Clean the filter every two weeks or more often if necessary.**

- A dirty filter reduces the efficiency of the air conditioner and could cause product malfunction or damage.

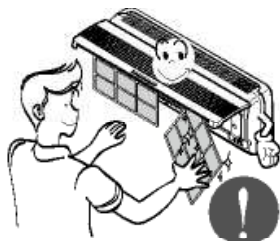

**Do not insert hands or other objects through the air inlet or outlet while the air conditioner is plugged in.**

- There are sharp and moving parts that could cause personal injury.



**Do not drink the water drained from the unit.**

- It is not sanitary and could cause serious health issues.

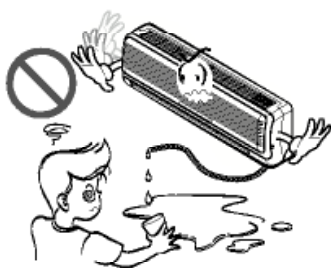

**Use a firm stool or ladder when cleaning or maintaining the air conditioner.**

- Be careful and avoid personal injury.



**Replace the all batteries in the remote control with new ones of the same type. Do not mix old and new batteries or different types of batteries.**

- There is risk of fire or explosion.

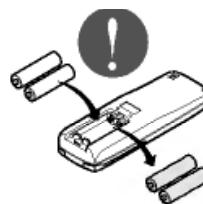

## ■ Disuse

**Do not recharge or disassemble the batteries. Do not dispose of batteries in a fire.**

- They may burn or explode.



**If the liquid from the batteries gets onto your skin or clothes, wash it well with clean water. Do not use the remote if the batteries have leaked.**

- The chemicals in batteries could cause burns or other health hazards.





# Prior to Operation

## Preparing for Operation

1. Contact an installation specialist for installation.
2. Plug in the power plug properly.
3. Use a dedicated circuit.
4. Do not use an extension cord.
5. Do not start/stop operation by plugging/unplugging the power cord.
6. If the cord/plug is damaged, only replace it with an authorized replacement part.

## Usage

1. Being exposed to direct airflow for a long time may be hazardous to your health. Do not expose occupants, pets, or plants to direct airflow for a long time.
2. Ventilate the room when the air conditioner is used with other heating devices. Otherwise the oxygen supply may be inadequate.
3. Do not use this air conditioner for non-specified special purpose (e.g. preserving precision devices, food, pets, plants, or art objects). Such use may damage your properties.

## Cleaning and Maintenance

1. Do not touch the metal parts of the unit when removing the filter. Injury can occur.
2. Do not use water to clean inside the air conditioner. Exposure to water can destroy the insulation, leading to electric shock.
3. When cleaning the unit, first make sure that the power and breaker are turned off. The fan rotates at a very high speed during operation. There is a possibility of injury if the unit power is accidentally turned on while the interior of the unit is being cleaned.

## Service

For repair and maintenance, contact your authorized service dealer.

## Electrical Safety

### **⚠ WARNING**

- This appliance must be properly grounded.  
To minimize the risk of electric shock, you must always plug into a grounded outlet
- Do not cut or remove the grounding prong from the power plug.
- Attaching the adapter ground terminal to the wall receptacle cover screw does not ground the appliance unless the cover screw is metal and not insulated, and the wall receptacle is grounded through the house wiring.
- If you have any doubt whether the air conditioner is properly grounded, have the wall receptacle and circuit checked by a qualified electrician.

### *Temporary Use of an Adapter*

We **strongly discourage** the use of an adapter due to potential safety hazards. For temporary connections, use only a UL-listed adapter, available from most local hardware stores. Ensure that the large slot in the adapter is aligned with the large slot in the receptacle for a proper polarity connection.

To disconnect the power cord from the adapter, use one hand on each to avoid damaging the ground terminal. Avoid frequently unplugging the power cord as this can lead to eventual ground terminal damage.

### **⚠ WARNING**

- Never use the appliance with a broken adapter.

### *Temporary Use of an Extension Cord*

We strongly discourage the use of an extension cord due to potential safety hazards. For temporary situations, use only CSA certified and UL listed 3-wire grounded extension cords, rated 15 A, 125 V.

# Operating Instruction

ENGLISH

## How to insert the Batteries

- 1** Remove the battery cover by pulling it according to the arrow direction.
- 2** Insert new batteries making sure that the (+) and (-) of battery are installed correctly.
- 3** Reattach the cover by sliding it back into position.

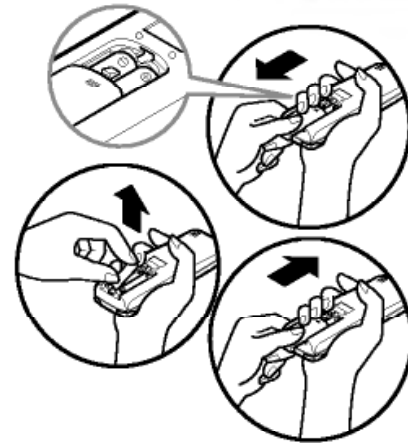

**NOTICE** Use 2 AAA(1.5volt) batteries. Do not use rechargeable batteries.

## Storage and Tips For Using the Remote Controler

- The remote controler may be stored by mounting it on a wall.
- To operate the room air conditioner, aim the remote control at the signal receptor.

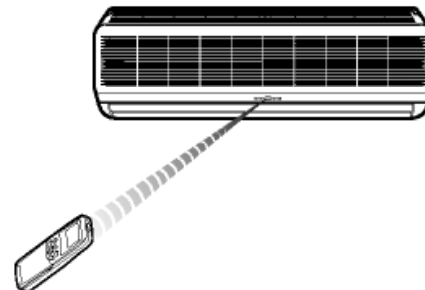
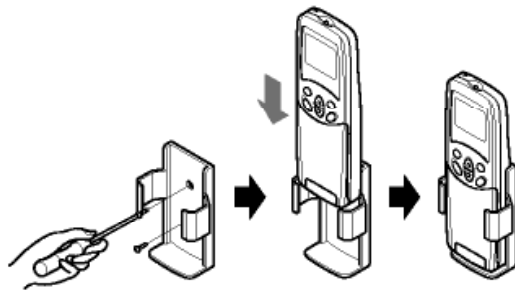

### Signal Receptor

Receives the signals from the remote control.(Signal receiving sound: two short beeps or one long beep.)

### Operation Indication Lamps

- On/Off : Lights up during the system operation.
- Sleep Mode : Lights up during Sleep Mode Auto operation.
- Timer : Lights up during Timer operation.
- Defrost Mode : Lights up during Defrost Mode or Hot Start operation (Heat pump model only)
- OUT DOOR** Outdoor unit operation : Lights up during outdoor unit operation. (Cooling model only)

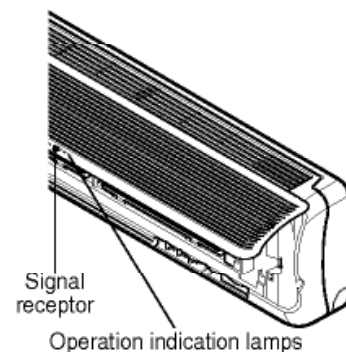

## Remote Control Operations

The remote control transmits the signals to the system.

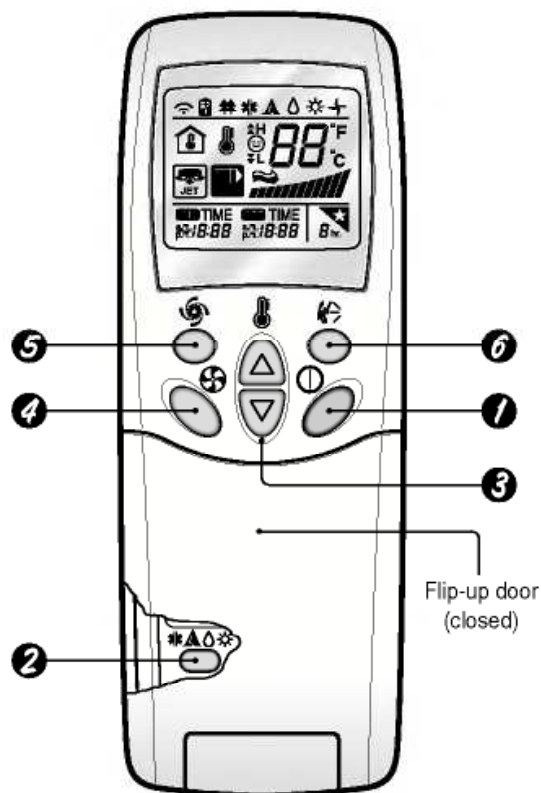

**1 START/STOP BUTTON**  
Operation starts when this button is pressed and stops when the button is pressed again.



**2 OPERATION MODE SELECTION BUTTON**  
Used to select the operation mode.



**3 ROOM TEMPERATURE SETTING BUTTONS**  
Used to select the room temperature.



**4 INDOOR FAN SPEED SELECTOR**  
Used to select fan speed in four steps low, medium, high, or CHAOS.



**5 JET COOL**  
Used to start or stop the speed cooling. (Speed cooling operates super high fan speed in cooling mode.)



**6 CHAOS SWING BUTTON**  
Used to stop or start louver movement and set the desired up/down airflow direction.

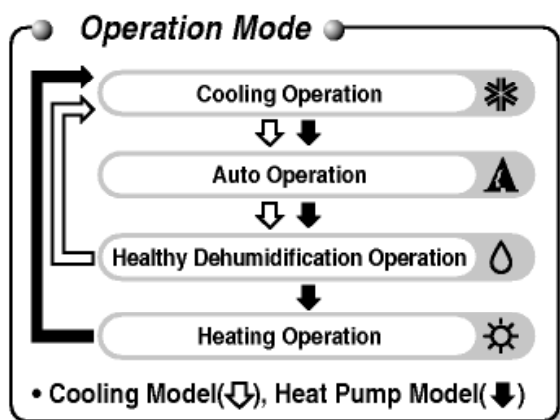

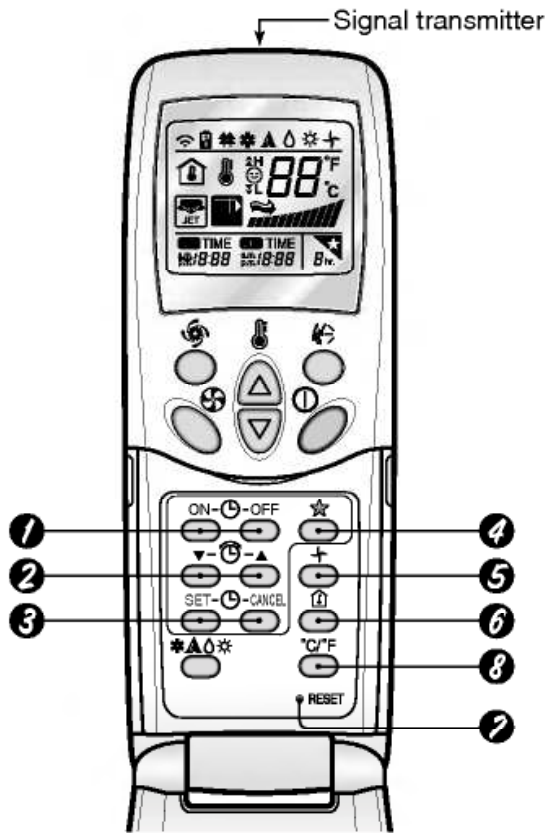

- 1 ON/OFF TIMER BUTTONS**  
Used to set the time of starting and stopping operation.
- 2 TIME SETTING BUTTONS**  
Used to adjust the time. (See page 19)
- 3 TIMER SET/CANCEL BUTTONS**  
Used to set the timer when the desired time is obtained and to cancel the Timer operation. (See page 19)
- 4 SLEEP MODE AUTO BUTTON**  
Used to set Sleep Mode Auto operation. (See page 19)
- 5 AIR CIRCULATION BUTTON**  
Used to circulate the room air without cooling or heating (turns indoor fan on/off). (See page 20)
- 6 ROOM TEMPERATURE CHECKING BUTTON**  
Used to check the room temperature.
- 7 RESET BUTTON**  
Used prior to resetting time or after replacing batteries.
- 8 °C TO °F SWITCHING BUTTON**  
Used to switch temperature reading from Centigrade to Fahrenheit.



## Cooling Operation

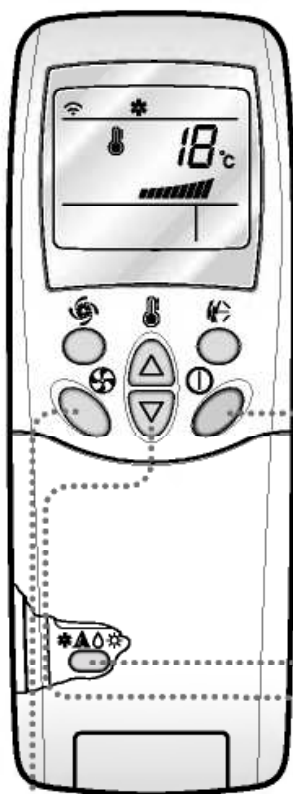

1

Press the Start/Stop button. The unit will respond with a beep.



2

Open the door on the remote control. To select **Cooling Operation**, press the Operation Mode Selection button. Each time the button is pressed, the operation mode is shifted in the direction of the arrow.

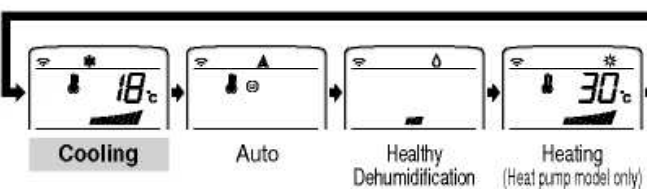

3

Close the door on the remote control. Set the temperature lower than the room temperature. The temperature can be set within a range of 18°C~30°C (64°F~86°F) in 1°C (2°F) increments.

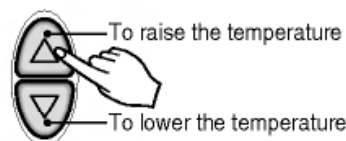

4

Set the fan speed again with the door of the remote control still closed. You can select the fan speed in four steps—low, medium, high, or CHAOS. Each time the button is pressed, the fan speed mode is shifted.



### Natural wind by the CHAOS logic

- For more fresh feeling than other fan speed, press the Indoor Fan Speed Selector and set to CHAOS mode. In this mode, the wind blows like natural breeze by automatically changing fan speed according to the CHAOS logic.



## Auto Operation

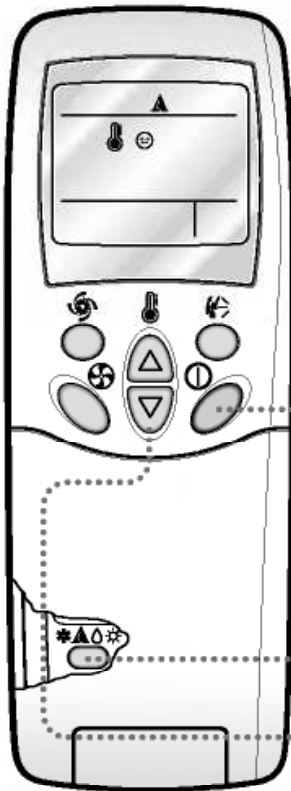

- 1** Press the Start/Stop button.  
The unit will respond with a beep.



- 2** Open the door on the remote control. To select **Auto Operation**, press the Operation Mode Selection button. Each time the button is pressed, the operation mode is shifted in the direction of the arrow.

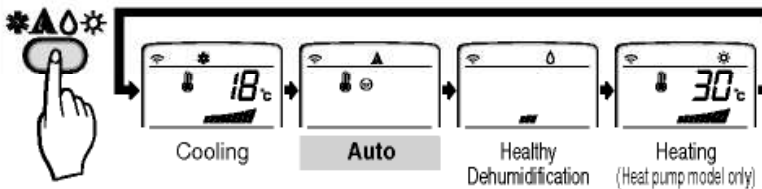

- 3** The temperature and fan speed are automatically set by the electronic controls based on the actual room temperature. If you want to change the set temperature, close the door on the remote control and press the Room Temperature Setting buttons. The cooler or warmer you feel, the more times (up to two times) you should press the button. The set temperature will then be changed automatically.

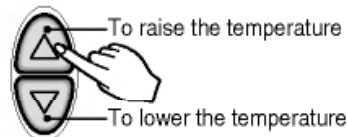

### During Auto Operation:

- You cannot switch the indoor fan speed. It has already been set by the Fuzzy rule.
- If the system is not operating as desired, manually switch to another mode. The system will not automatically switch from the cooling mode to the heating mode, or from heating to cooling, it must be done by manually resetting.
- During Auto Operation, pressing the chaos swing button makes the horizontal louvers swing up and down automatically. If you want to stop auto-swing, press the chaos swing button again.



## Healthy Dehumidification Operation Mode

This mode dehumidifies without overcooling.

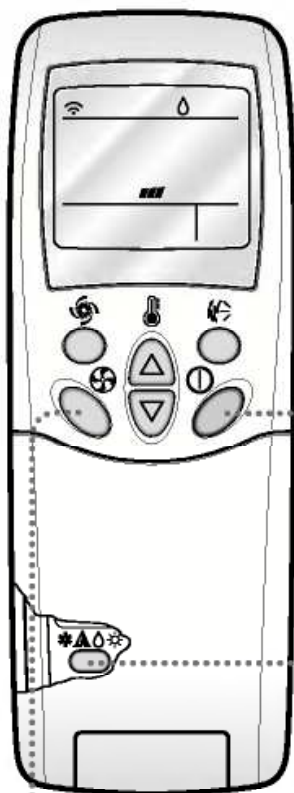

1 Press the Start/Stop button.  
The unit will respond with a beep.



2 Open the door on the remote control. To select **Healthy Dehumidification Operation**, press the Operation Mode Selection button.  
Each time the button is pressed, the operation mode is shifted in the direction of the arrow.

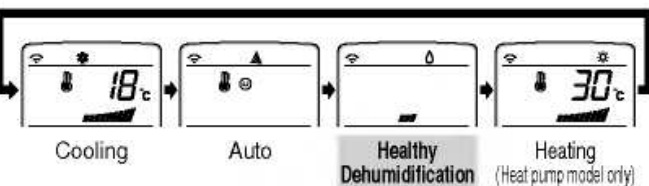

3 Set the fan speed again with the door of the remote control still closed. You can select the fan speed in four steps—low, medium, high, or CHAOS. Each time the button is pressed, the fan speed mode is shifted.



### Natural wind by the CHAOS logic

- For more fresh feeling than other fan speed, press the Indoor Fan Speed Selector and set to CHAOS mode. In this mode, the wind blows like natural breeze by automatically changing fan speed according to the CHAOS logic.

### During Healthy Dehumidification Operation:

- If you select the dehumidification mode on the operation selection button, the airconditioner starts to run the dehumidification function, automatically setting the room temp. and airflow volume to the best condition for dehumidification based on the sensed current room temp.

In this case, however, the setting temp. is not displayed in the remote control and you are not able to control the room temp. either.

- During the healthy dehumidification function, the airflow volume is automatically set according to the optimization algorithm responding to the current room temp. status and makes the room condition healthy and comfortable even in the high humidity season.





## Heating Operation(Heat pump model only)

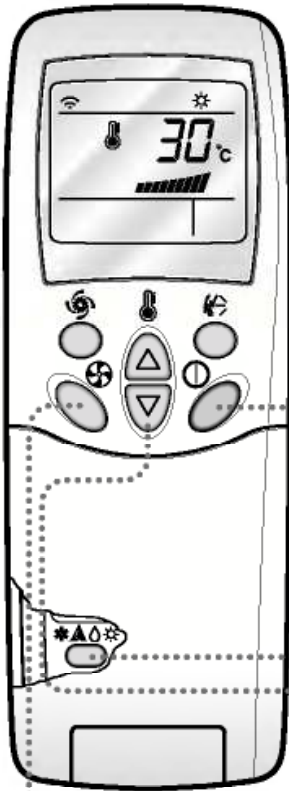

**1**

Press the Start/Stop button.  
The unit will respond with a beep.



**2**

Open the door on the remote control. To select **Heating Operation**, press the Operation Mode Selection button. Each time the button is pressed, the operation mode is shifted in the direction of the arrow.

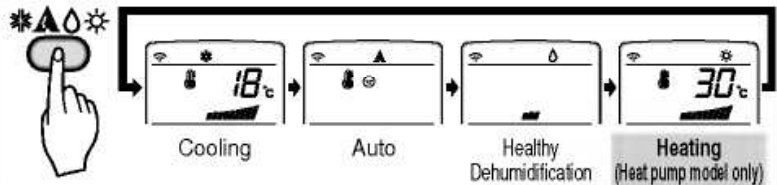

**3**

Close the door on the remote control. Set the temperature higher than the room temperature. The temperature can be set within a range of 16°C~30°C (60°F~86°F) in 1°C (2°F) increments.

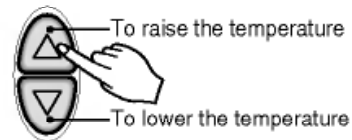

**4**

Set the fan speed again with the door of the remote control still closed. You can select the fan speed in four steps—low, medium, high, or CHAOS. Each time the button is pressed, the fan speed mode is shifted.





## Jet Cool Operation

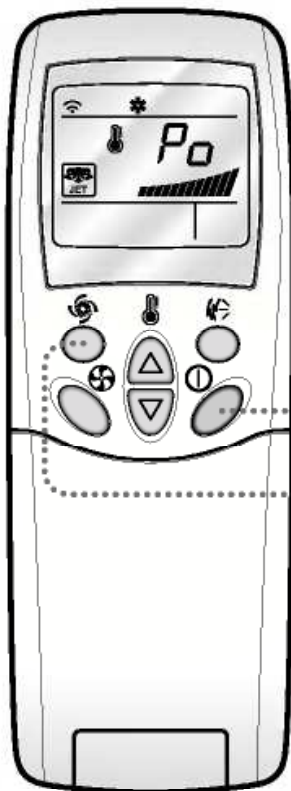

**1**

Press the Start/Stop button. The unit will respond with a beep.



**2**

Press the **Jet Cool** button to operate the speed cooling mode and the unit will operate in super high fan speed on cooling mode for 30 minutes.



**3**

To cancel the **Jet Cool** mode, press the **Jet Cool** button again or the fan speed button or the room temperature setting button and the unit will operate in high fan speed on cooling mode.



### NOTICE

□ During the **JET COOL** function at any moment, the A/C starts to blow the cool air at extremely high speed for 30 minutes setting the room temp. automatically to 18°C. It is especially used to cool the room temp. Quickly in a hot summer.

In the heat pump mode, neuro fuzzy mode, or auto changeover mode however, the **JET COOL** function is not available.

□ In order to return to the normal cooling mode from the **JET COOL** mode, you just press either the operation mode selection button, airflow volume selection or temp. setting button or the **JET COOL** button again.

# Additional features



## Sleep Mode

1. Press the Sleep Mode Auto button to set the time you want the unit to turn off automatically.
2. The Timer is programmed in one-hour increments by pressing the Sleep Mode Auto button 1 to 7 times.  
The sleep mode is available for 1 to 7 times. To alter the time period in steps of 1 hour, press the Sleep Mode Button while aiming at air conditioner.
3. Make sure the Sleep Mode Auto LED lights up.



To cancel the Sleep Mode, press the sleep Mode Auto button several times until the star ( ☆ ) disappears from the operation display.

### NOTICE

The Sleep Mode will be operated at slow fan speed (cooling) or medium fan speed (heat pump only) for quiet sleeping.

IN COOLING MODE OR HEALTHY DEHUMIDIFICATION MODE:

The temperature will automatically rise by 1°C (2.0°F) over the next 30 minutes and by 2°C (4.0°F) in 1 hour for comfortable sleeping.



## Setting the Time

1. Time can be set only when you have pressed the Reset button. If you have just replaced the batteries, the Reset button should be pressed to reset the time.

Press the Start/Stop button.



2. Press the Time Setting buttons until the desired time is set.

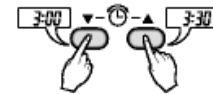

3. Press the Timer SET button.



### NOTICE

Check the indicator for A.M. and P.M.



## Delay Start/Pre-Set Stop

1. Make sure the time is set correctly on the remote control display.

2. Press the ON/OFF Timer buttons to turn Timer on or off.

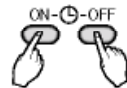

3. Press the Time Setting buttons until the desired time is set.



4. Press the selected on/off setting by pressing the Timer SET button while aiming the remote control at the signal receptor.



### To cancel the timer setting

Press the Timer Cancel button while aiming remote control at the signal receptor.



(The timer lamp on the air conditioner and the display will go out.)

**NOTICE** Select one of the following four types of operation.

with the unit running



Delay OFF Timer



Delay ON Timer

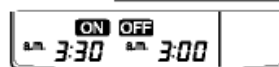

Delay OFF and ON Timer

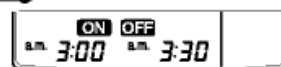

Delay ON and OFF Timer



## Vertical Airflow Direction Control

The up/down airflow (Vertical Airflow) can be adjusted by using the remote control.



1. Press the Start/Stop button to start the unit.

2. Open the door on the remote control.

Press Chaos Swing button and the louvers will swing up and down. Press the Chaos Swing button again to set the vertical louver at the desired airflow direction.



### NOTICE

- If you press the CHAOS swing button, the vertical airflow direction is changed automatically based on the CHAOS algorithm to distribute the air in the room evenly and at the same time to make the human body feel most comfortable, as if enjoying a natural breeze.
- Always use the remote control to adjust the up/down airflow direction. Manually moving the vertical airflow direction louver by hand could damage the air conditioner.
- When the unit is shut off, the up/down airflow direction louver will close the air outlet vent of the system.

To adjust left/right(Horizontal Airflow) direction

### ⚠ WARNING

Ensure unit is turned off before adjusting the horizontal airflow direction control. Carefully open vertical louver to allow access to the horizontal airflow direction.



Adjust the left/right airflow direction by hand.



## Air Circulation Mode

Circulates the room air without cooling or heating.

1. Press the Start/Stop button. the unit will respond with a beep.
2. Open the door on the remote control. Press the Air Circulation button. Close the door on the remote control. Now each time that you press the Indoor Fan Speed Selector, the fan speed is shifted from low to CHAOS and back to low again.

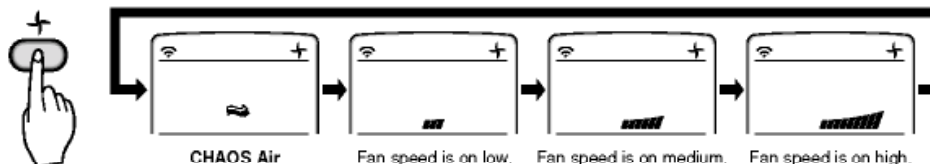

### NOTICE

- **CHAOS Air** economizes power consumption and prevents overcooling. The fan speed is automatically changed from high to low or vice versa, depending on the ambient temperature.



## Forced Operation

Operation procedures when the remote control can't be used. Open the front panel upward and move the Slide Switch to the Forced Operation position.

If you want to stop operation, move the Slide Switch to the Auto Restart or the Remote Control position.

In case the power comes on again after power failure on the Forced Operation position, the operating conditions are automatically set as follows:

During Forced Operation, the initial mode continues.

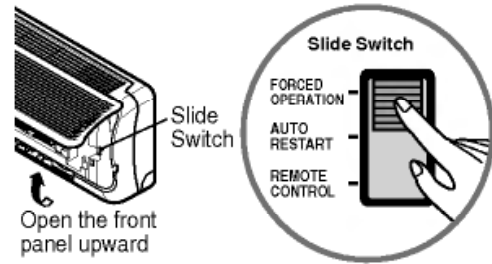

	Cooling Model	Heat pump Model		
		Room Temp. $\geq 24^{\circ}\text{C}(75.2^{\circ}\text{F})$	$21^{\circ}\text{C}(69.8^{\circ}\text{F}) \leq \text{Room Temp.} < 24^{\circ}\text{C}(75.2^{\circ}\text{F})$	Room Temp. $< 21^{\circ}\text{C}(69.8^{\circ}\text{F})$
Operating mode	Cooling	Cooling	Healthy Dehumidification	Heating
Indoor FAN Speed	High	High	Healthy Dehumidification Rule	High
Setting Temperature	$22^{\circ}\text{C}(71.6^{\circ}\text{F})$	$22^{\circ}\text{C}(71.6^{\circ}\text{F})$	$23^{\circ}\text{C}(73.4^{\circ}\text{F})$	$24^{\circ}\text{C}(75.2^{\circ}\text{F})$



## Auto restart

In case the power comes on again after a power failure, Auto Restarting Operation is the function to operate procedures automatically to the previous operating conditions.

If you want to use this operation, Open the front panel upward and move the slide switch to the Auto Restart position.

If you do not want to use this operation, move the Slide Switch to the Remote Control position.

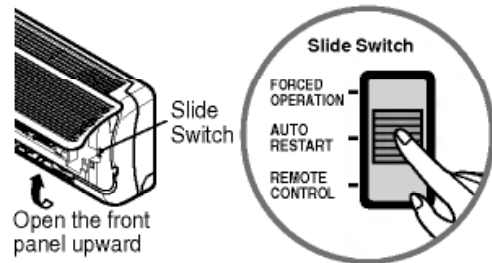

*When you are out for a while, put the Slide Switch on the Remote Control.*

### Helpful information

Fan speed and cooling capacity.

The cooling capacity indicated in the specification is the value when the fan speed is set to high, and the capacity will be lower at low or medium fan speed.

High fan speed is recommended when you wish to cool the room quickly.

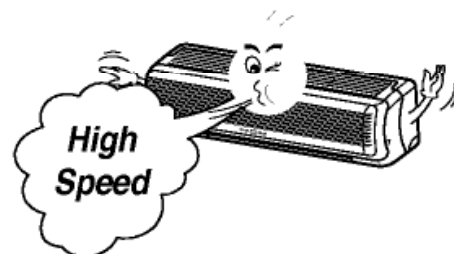

## Maintenance and Service

### ⚠ CAUTION

Before performing any maintenance, turn off the main power to the system.

### Indoor Unit

#### Grille, Case, and Remote Control

- Turn the system off before cleaning. To clean, wipe with a soft, dry cloth. Do not use bleach or abrasives.

#### NOTICE

Supply power must be disconnected before cleaning the indoor unit.

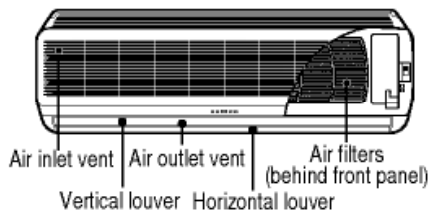

#### AIR FILTER

The air filters behind the front grille should be checked and cleaned once every 2 weeks or more often if necessary.

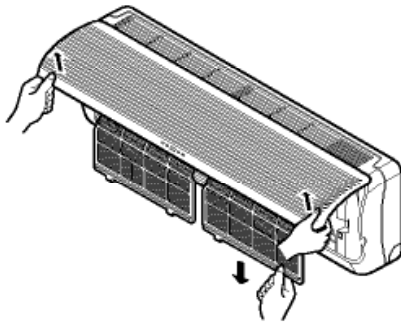

- Never use any of the followings:

- Water hotter than 40°C(104°F)  
Could cause deformation and/or discoloration.
- Volatile substances  
Could damage the surfaces of the air conditioner.



1. Lift the front access panel and pull the filter tab slightly forward to remove the filter.
2. Clean the filter with a vacuum or warm, soapy water.
  - If dirt is conspicuous, wash with a solution of detergent in lukewarm water.
  - If hot water (40°C (104°F) or more) is used, it may be deformed.
3. After washing with water, dry well in the shade.
4. Re-install the air filter.

### Replacement of Purifying Filter(Optional)

- Recommended use period : About 2 years

1. Open front panel and remove air filters.
2. Remove air purifying filters.

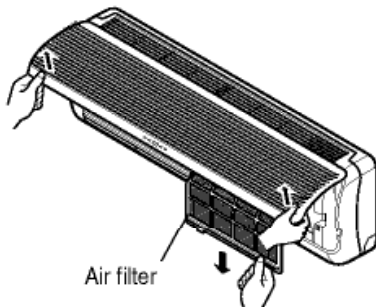

3. Insert new air purifying filters.

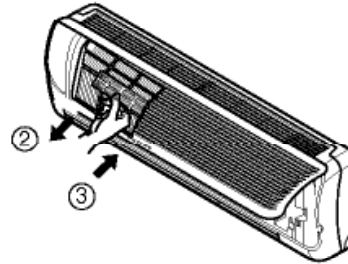

4. Reinsert air filters and close front panel.

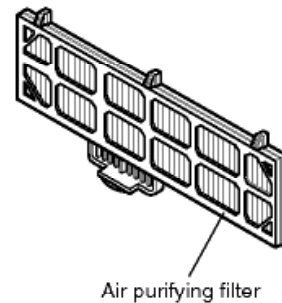
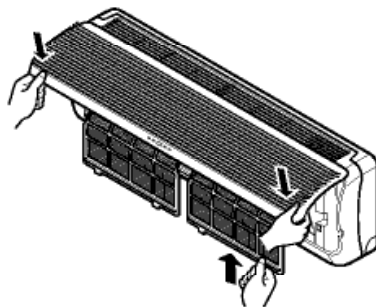

## Outdoor Unit

The heat exchanger coils and panel vents of the outdoor unit should be checked regularly. If clogged with dirt or soot, the heat exchanger and panel vents may be professionally steam cleaned.

### NOTICE

*Dirty or clogged coils will reduce the operating efficiency of the system and cause higher operating costs.*

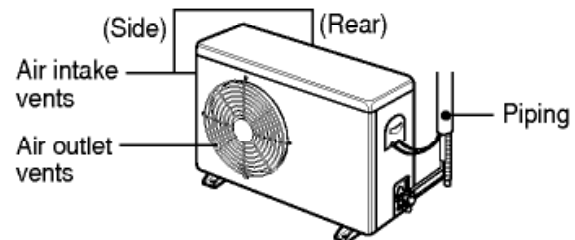

## Common Problems and Solutions

### Before calling for service

If you have problems with your air conditioner, read the following information and try to solve the problem. If you cannot find a solution, turn off the air conditioner and contact your dealer.

### Air conditioner does not operate

1. Ensure that the air conditioner is plugged into a proper outlet.
2. Check the fuse or circuit breaker.
3. Check whether the voltage is unusually high or low.

### Air does not feel cold enough on the cooling setting

1. Ensure that the temperature settings are correct.
2. Check to see if the air filter is clogged with dust. If so, replace the filter.
3. Ensure that the air flow from the outside is not obstructed and that there is a clearance of over 20" between the back of the air conditioner and the wall or fence behind it.
4. Close all doors and windows and check for any source of heat in the room.



Before calling for service, please review the following list of common problems and solutions.

### *The air conditioner is operating normally when:*

- You hear a pinging noise. This is caused by water being picked up by the fan on rainy days or in highly humid conditions. This feature is designed to help remove moisture in the air and improve cooling efficiency.
- You see water dripping from the rear of the unit. Water may be collected in the base pan in highly humid conditions or on rainy days. This water overflows and drips from the rear of the unit.
- You hear the fan running while the compressor is silent. This is a normal operational feature.



## Troubleshooting

The air conditioner may be operating abnormally when:

<i>Problem</i>	<i>Possible Causes</i>	<i>What To Do</i>
Air conditioner does not start	<ul style="list-style-type: none"> <li>■ The air conditioner is unplugged.</li> </ul>	<ul style="list-style-type: none"> <li>• Make sure the air conditioner plug is pushed completely into the outlet.</li> </ul>
	<ul style="list-style-type: none"> <li>■ The fuse is blown/circuit breaker is tripped.</li> </ul>	<ul style="list-style-type: none"> <li>• Check the house fuse/circuit breaker box and replace the fuse or reset the breaker.</li> </ul>
	<ul style="list-style-type: none"> <li>■ Power failure.</li> </ul>	<ul style="list-style-type: none"> <li>• If power failure occurs, turn the mode control to Off. When power is restored, wait 3 minutes to restart the air conditioner to prevent tripping of the compressor overload.</li> </ul>
Air conditioner does not cool as it should	<ul style="list-style-type: none"> <li>■ Airflow is restricted.</li> </ul>	<ul style="list-style-type: none"> <li>• Make sure there are no curtains, blinds, or furniture blocking the front of the air conditioner.</li> </ul>
	<ul style="list-style-type: none"> <li>■ The air filter is dirty.</li> </ul>	<ul style="list-style-type: none"> <li>• Clean the filter at least every 2 weeks. See the care and Maintenance section.</li> </ul>
	<ul style="list-style-type: none"> <li>■ The room may have been hot.</li> </ul>	<ul style="list-style-type: none"> <li>• When the air conditioner is first turned on, you need to allow time for the room to cool down.</li> </ul>
	<ul style="list-style-type: none"> <li>■ Cold air is escaping.</li> </ul>	<ul style="list-style-type: none"> <li>• Check for open furnace floor registers and cold air returns.</li> </ul>
	<ul style="list-style-type: none"> <li>■ Cooling coils have iced up.</li> </ul>	<ul style="list-style-type: none"> <li>• See Air Conditioner Freezing Up below.</li> </ul>

\* You can refer to the Energy Star program in detail at [www.energystar.gov](http://www.energystar.gov).

