

**Breezee®**  
NATURALLY COOLER

# Installation and Operating Manual

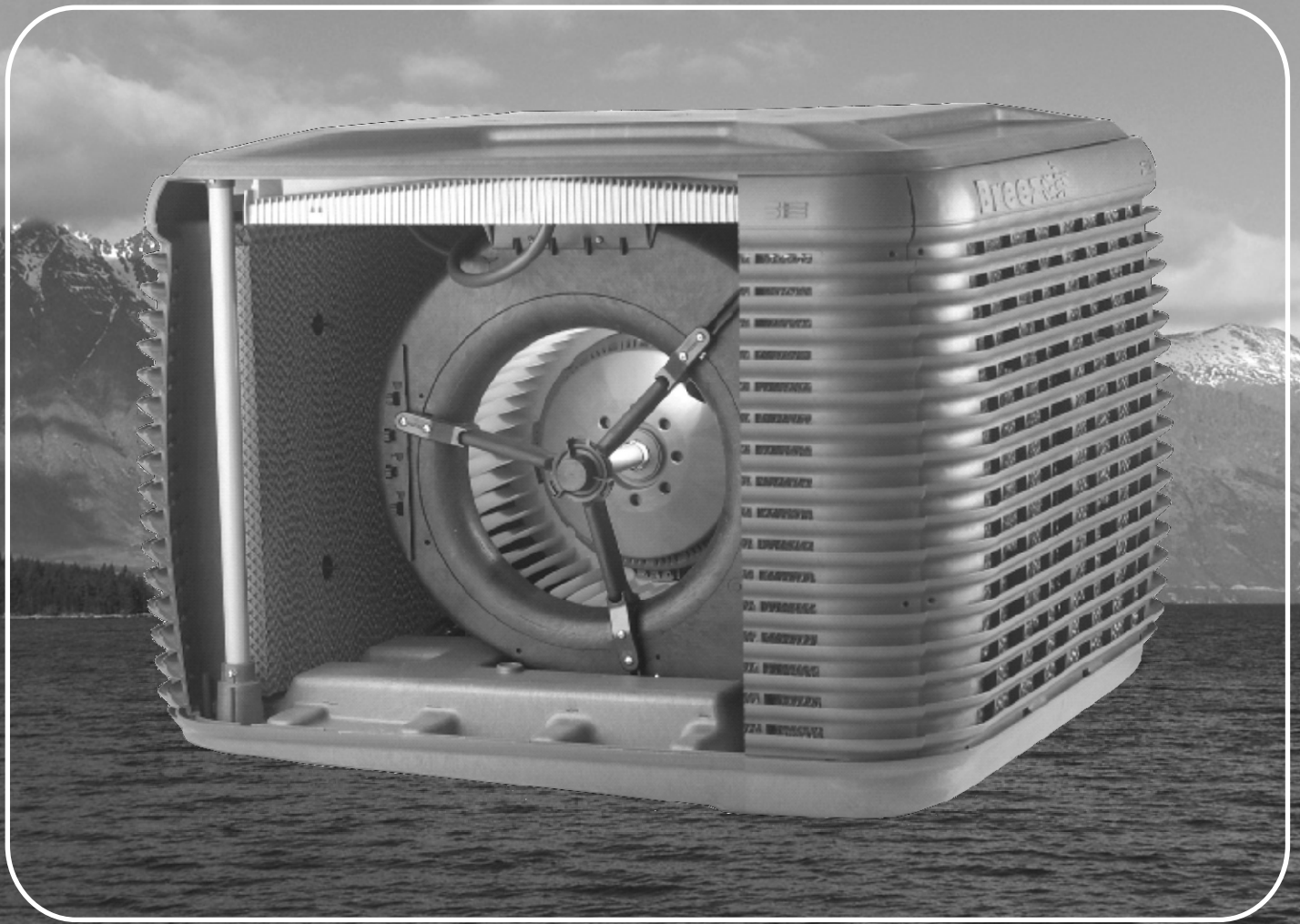

## EXH Series

Evaporative Air Coolers

Seeley International (Americas)

**INDEX****SAFETY.....1****OPERATING INSTRUCTIONS**

Thermostat Range.....2

Using the *SENSORTOUCH*® Remote Control.....3Using the *SENSORTOUCH*® Wall Control.....7

Maintenance.....9

Pre-Assembly Inspection..... 10

**INSTALLATION INSTRUCTIONS**

Installation Details.....11

Water Installation..... 12

Electrical Installation..... 13

*SENSORTOUCH*® Wall Control..... 13*SENSORTOUCH*® Remote Control.....14

Testing the cooler.....16

Installation Checklist..... 17

**TROUBLE SHOOTING .....18****APPENDIX A - Wiring Diagrams.....20**

**SAFETY INSTRUCTIONS****Important Safety Instructions and Warnings**

**WARNING:** The warnings and safety instructions in this manual must be followed to reduce the risk of fire, electric shock or injury, and to provide reasonable safety and efficiency in using this Evaporative Air Cooler. The operator is responsible for following the warnings and instructions in this manual and on the cooler.

**Read this entire manual before proceeding to install the cooler.**

**Restrict the use of this cooler to persons who read, understand and can follow the warnings and instructions in this manual and on the cooler. NEVER ALLOW CHILDREN TO OPERATE THE COOLER.**

**Failure to observe these warnings and instructions will void manufacturer's warranties and will discharge the manufacturer of all liability.**

**CAUTION!**

**ALWAYS disconnect the cooler from the power supply before commencing maintenance procedures.**

During maintenance procedures, NEVER use a naked flame for any inspection or cleaning purpose as a fire could be caused by a flame coming into contact with the cooler materials.

**Avoid Dangerous Situations: Protect the cooler from all sources of ignition because polymers and cooling pads will burn.**

NEVER use a water hose to squirt the interior of the cooler for cleaning as residual water could damage electrical components and create the risk of fire and /or electric shock to the user after re-assembly.

**INSTALLATION, REPAIR AND OPERATION**

● All installation and repair work must conform to local electrical, water supply and environmental codes, rules and regulations and applicable national standards.

● **All installation, maintenance and repair work must be done by a licensed and qualified electrician and/or a qualified, experienced heating, ventilating, air conditioning technician. All such work must be effected with factory authorized spare parts only.**

● Disconnect electrical power at the fuse or circuit breaker box before installation commences. ALWAYS turn OFF the isolating switch (disconnect) located on the electronic module inside the cooler BEFORE commencing any maintenance

● Use only the power supply voltage shown on the motor/cabinet nameplate.

● Do not install or service the air cooler during rain, high wind or severe weather conditions.

● Keep children, bystanders and animals at a safe distance, a minimum of 30ft (10m) away from working areas.

● Dress safely. Wear non-skid shoes when working at high levels and roofs. Do not wear loose clothing or personal accessories while installing or servicing the air cooler as they may become caught in moving parts.

● Keep loose hair, loose clothing, fingers and all other parts of the body away from openings and moving parts.

● Check the cooler for worn, loose, missing, or damaged parts before operation.

● If you work with power tools, wear protective eyewear and gloves.

● Take care when lifting or raising the air cooler to its final location. Use safe equipment and never attempt to lift the cooler alone. Always have assistance. Otherwise you might damage the cooler or the building or injure yourself.

● Ground Fault Circuit Interrupter (GFCI) protection should be provided on the circuit supplying this air cooler. Receptacles are available with built-in GFCI protection.

● Air coolers installed on roofs must not have the waste water directed onto the roof as stains will occur. Connect the cooler drain outlet to a gutter or drain pipe using a suitable hose.

● Always use the correct tools.

● **WARNING!** the packaging plastic on this cooler can be a safety hazard. Dispose of carefully.

● Never drill holes in the pan or walls of the cooler.

● Avoid dangerous situations. Do not use the cooler in the presence of flammable liquids or gasses to avoid creating fire or explosion. This air cooler is NOT flame retardant. A fire may result from contact with a flame or from an electrical short.

● Use of wrong replacement parts creates risk of severe electric shock and fire which may result in serious property damage, personal injury or death.

**WATER PUMP**

The water pump is supplied with this cooler and is factory fitted into its correct location.

Ensure that it is properly secured and upright as intended.

There is no need to adjust the water flow since the cooler is designed to operate with maximum cooling at low air velocities.

**Water pump replacement**

Factory authorized pumps are fitted with thermal overload protection. Water pumps may seize up and overheat, creating a fire risk. Pumps that have thermal overload protection are designed to shut off the pump if the motor overheats.

**Factory Authorized water pump**

Seeley "Tornado" pump (part no. 095905)

**"Power Clean" Style Timed Pumps**

**Under no circumstances are "Power Clean" style timed pumps to be used in any Breezair evaporative air cooler. Use of these devices or any other non-approved device will cause serious damage to the special safety circuits of this cooler. Failure to follow this instruction will VOID ALL WARRANTY and may create severe risk of electric shock and fire!**

**FAN MOTOR**

This cooler is supplied with a fan motor made by the cooler manufacturer. USE ONLY THE AUTHORIZED FAN MOTOR SUPPLIED.

**Failure to follow this instruction will VOID ALL WARRANTY and may create severe risk of electric shock and fire!**

**Factory Authorized Fan Motor**

Seeley Direct Drive motors:

750W (1HP) motor part # 095943  
1500W (2HP) motor part # 095967

The fan motor is equipped with inbuilt overheating protection that will reset automatically on cool-down to a safe temperature. This may take up to 45 minutes.

**CIRCUIT BREAKER PROTECTION**

This cooler is fitted with circuit breaker protection for the fan motor and pump.

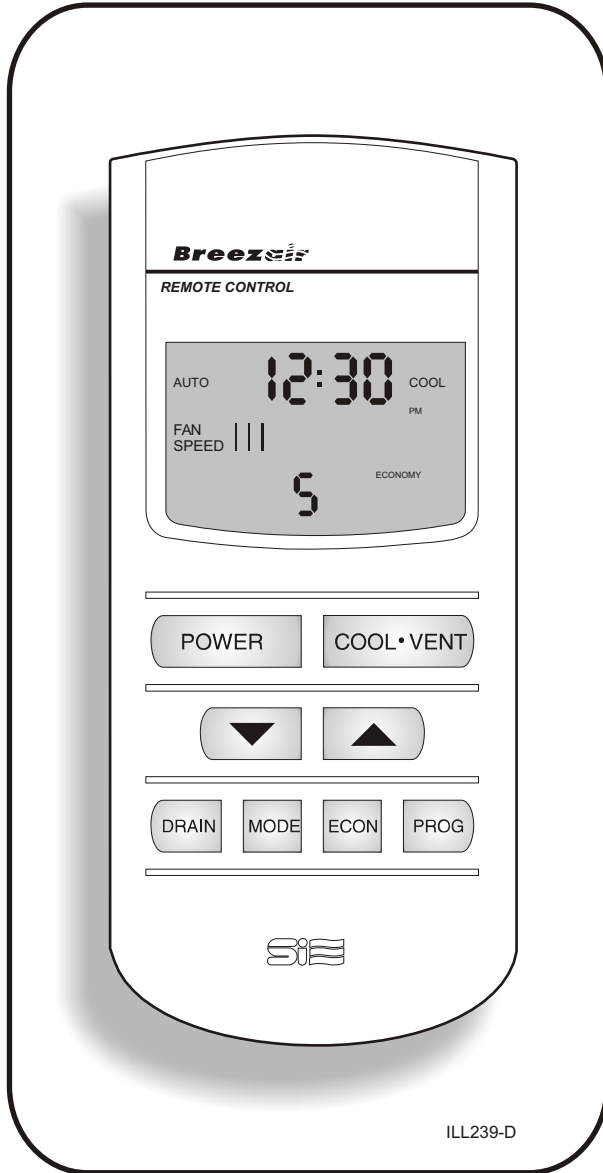

**SENSORTOUCH**<sup>®</sup>  
Remote Thermostat Control  
(remote control)

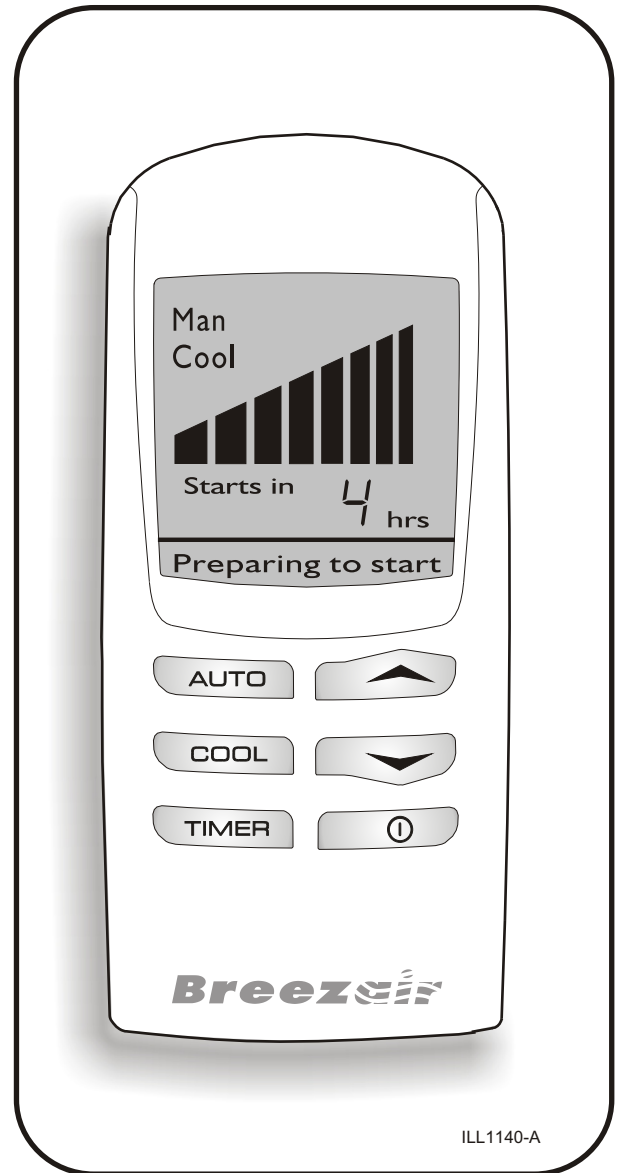

**SENSORTOUCH**<sup>®</sup>  
Wall Mounted Thermostat Control  
(wall control)

### SETTING THE CLOCK

Set the clock on the remote control before proceeding with any other programming.

The clock can only be set with the remote control switched OFF. Hold the **PROG** button down for over 2 seconds, until the hour flashes. The clock can be set to either 12 or 24 hours (see page 6). If the clock is set to 12 hours make sure that the AM/PM displayed on the screen is correct. AM/PM will change with adjustment of the hour.



ILL1104-A

Use the **▼** and **▲** buttons to change the hour. To change minutes, press the **PROG** button again. Change the minutes using the **▼** and **▲** buttons.

To lock in the time setting, and enter the OFF state, press the **PROG** button. The display will stop flashing.

### TURNING ON THE COOLER

The remote control is switched on and off using the **POWER** button. The memory will store and use the settings from when the cooler was last used. Once the remote control is on, you can choose between MANUAL, AUTO and AUTO TIMER modes by pressing the **MODE** button.

### MANUAL MODE

With the remote control ON, press the **MODE** button until MANUAL is shown in the top left corner of the display.

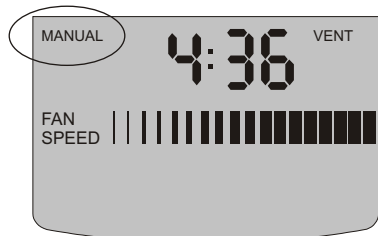

ILL1109-A

The **COOL-VENT** button is used to select VENT (where fresh air is being delivered without being cooled) or COOL.

### MANUAL MODE

Once either COOL or VENT has been selected, the remote control will maintain a constant fan speed. This is indicated by the bar graph in the centre of the display.

To decrease or increase the fan speed required, press either the **▼** or **▲** buttons.

### AUTO MODE

The remote control contains a thermostat. In AUTO mode the cooler is controlled automatically, based on your pre-selected comfort level. The cooler will adjust the fan speed, switch between COOL and VENT and turn itself off. However, the sequence and regularity at which these settings change will differ with each operation of the cooler.

As the remote control senses room conditions, the comfort control settings will be influenced by heat from direct sunlight or electrical appliances. Likewise placing the remote control in cupboards or drawers or under cooling vents will affect the cooler's operation.

To set the AUTO mode press the **MODE** button until AUTO is displayed.

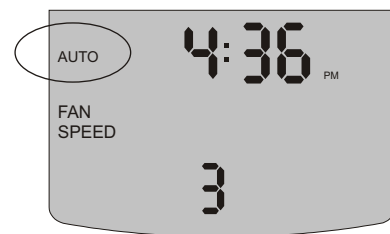

ILL1105-A

Ten levels of comfort are available with the remote control. While in AUTO mode pressing the **▼** and **▲** buttons will adjust the level of required comfort. The display will show your selection by indicating a level between 1 and 10. WARMER or COOLER will be displayed on the screen as settings are changed.

### AUTO TIMER MODE

AUTO TIMER mode can be selected by using the **PROG** button. Once the AUTO TIMER mode is selected the cooler will only operate during the programmed time period.

**AUTO TIMER MODE**

Programming the timer must be performed before AUTO TIMER can be activated. This can be done while in any mode, even when it is OFF. There are 7 steps involved in setting the AUTO TIMER.

NOTE: After pressing the **PROG** button the display will revert back to the previous setting if no buttons are pressed within 4 seconds.

To program the timer use the following sequence:

**(1) Setting the ON time hour**

Begin by pressing the **PROG** button. The hour displayed will start flashing and the word ON will appear on the screen. Then use the **▼** and **▲** buttons to change the hour value.

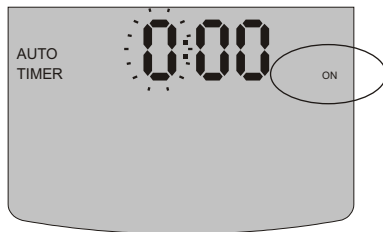

ILL1112-A

**(2) Setting the ON time minutes**

Press the **PROG** button. The minutes displayed will start flashing and the word ON will appear on the screen. Then use the **▼** and **▲** buttons to change the minute setting.

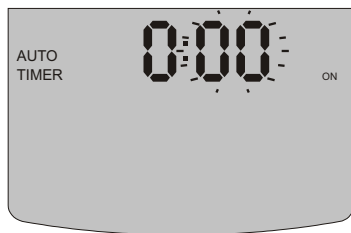

ILL1113-A

**(3) Setting the OFF time hour**

Press the **PROG** button. The hour displayed will start flashing and OFF will be displayed. Then use the **▼** and **▲** buttons to change the hour.

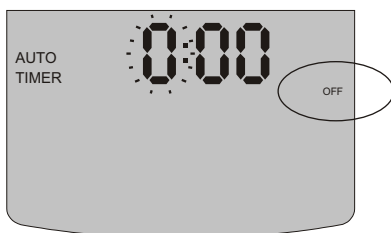

ILL1114-A

**(4) Setting the OFF time minutes**

Press the **PROG** button. The minutes displayed will start flashing and the word OFF will appear. Then use the **▼** and **▲** buttons to change the minute setting.



ILL1115-A

**(5) Setting the comfort level**

Press the **PROG** button and the comfort level number (1 to 10) displayed will start flashing. Then use the **▼** and **▲** buttons to change this setting.

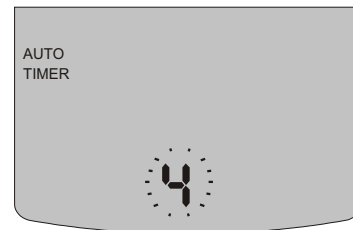

ILL1116-A

**(6) Setting ECONOMY**

To select economy press the **ECON** button so that it is displayed on the screen.

**(7) Activating AUTO TIMER**

Now that you have programmed the settings for AUTO TIMER they will be stored in the remote control's memory until you change them. Press the **MODE** button until AUTO TIMER is displayed on the screen. Your cooler will now only operate during the programmed time period.

NOTE: To change any AUTO TIMER settings when the remote control is switched off, the **PROG** button needs to be pressed and released within 1 second. To change settings when the remote control is turned on press the **PROG** button until the desired number is flashing.

**ECONOMY MODE**

Selecting the ECONOMY mode limits the maximum available cooling or ventilation and reduces the power used by up to 20%. The ECONOMY function can be used in either AUTO or MANUAL modes. To select this mode press the **ECON** button so that ECONOMY appears on the display.

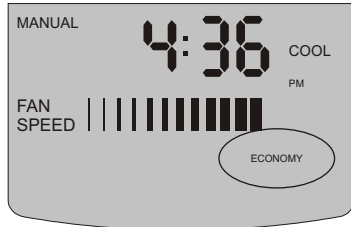

ILL1125-A

**DRAIN MODE**

Pressing the **DRAIN** button opens the drain valve in the cooler and empties the water in the tank. This will leave the tank clean and dry and turn the cooler off.

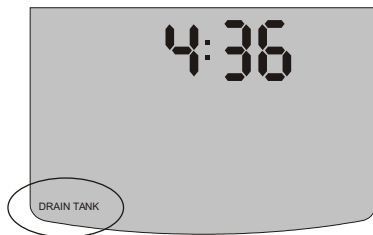

ILL1107-A

If the cooler has not been used for 3 days or 3 hours, depending on the DIP switch setting - see page 6, the tank will automatically be drained to ensure the system remains clean.

**PRE-COOL MODE**

Your remote control is designed to allow for the saturation of the cooler's cooling pads before the fan is switched on. This function, referred to as PRE-COOL mode, is enabled at DIP switch D (refer to page 6). Once it is enabled the cooler, when first switched on, will operate as follows:

- (1)..... If the pan is empty the drain system will be closed. The pan will then be filled.
- (2)..... The water inlet system allows water to fill the pan, until the water level reaches the lower pins of the water probe. After a 30 second delay, the pump will turn on and saturate the cooling pads.
- (3)..... After the pump has been running for 2 minutes the fan will start.

During this operation the word PRE-COOL will be displayed on the remote control's screen.

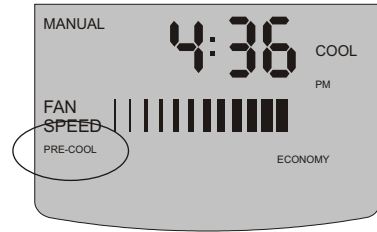

ILL1142-A

NOTE: PRE-COOL mode will not be activated if VENT is selected on the remote control or the cooler is used again shortly after having been turned off.

**WATER MANAGER**

The Breezair remote control is fitted with the WaterManager<sup>®</sup> feature which automatically monitors the quality of the water in the cooler.

The WaterManager<sup>®</sup> drains the existing water in the cooler to allow it to be replaced with fresh water, only when it is needed. Therefore, you may notice your cooler draining water occasionally. How often the WaterManager<sup>®</sup> performs this operation depends upon the quality of the water supply and the rate of evaporation.

In areas of poor water quality, the WaterManager<sup>®</sup> will operate more often as it tries to maintain the optimum water quality in the cooler. This maximizes the cooling effect and life of the cooling pads.

The remote control has a unique feature attached to the WaterManager<sup>®</sup> that allows you to specify either high or low salinity settings. The low salinity setting is used in specific circumstances only. We recommend talking with your dealer before adjusting this setting.

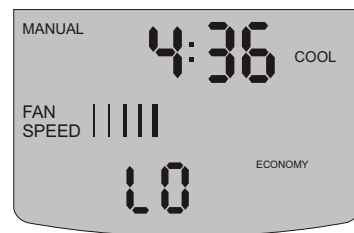

ILL1111-A

The high salinity setting is designed to operate the cooler at a maximum safe salinity level to maintain a normal working life. It also results in a minimum usage of water.

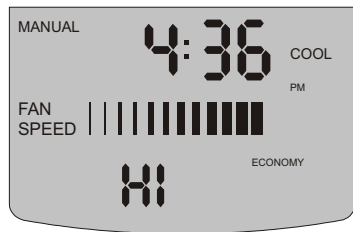

ILL1110-A

NOTE: High salinity outlet water should not be used on salt sensitive grass or plants. It has a high salt content.

The current WaterManager® setting is displayed by holding down the **ECON** button and pressing the **MODE** button. The setting can be changed by holding down the **ECON** button and pressing either the **▲** or **▼** button for HI and LO respectively.

The factory default WaterManager® setting is HI. For areas operating with bore water, DIP switch F should be switched to off (see page 6). This will disable the salinity measuring circuit and simply drain water from the tank every 65 minutes of operation.

**POWER FAILURE RECOVERY**

After a power disruption is restored, the cooler will automatically restart within 10 minutes, if the remote control has remained "ON" during the power failure.

**BATTERIES**

If the batteries are installed when the display is completely blank, the display will remain blank for 5 seconds. After 5 seconds the display will show "Id" for 1 second, then display the clock. The remote control is now ready to use. The remote control requires 3 AAA batteries. The use of good quality alkaline batteries is recommended. Under normal conditions a set of batteries will operate for 18 months. Do not use rechargeable batteries as their voltage rating is too low for the remote control. When the batteries are getting low on power, BATTERY LOW is displayed on the screen (the cooler may also switch off while the display remains ON). This indicates that the batteries have only a small amount of life remaining.

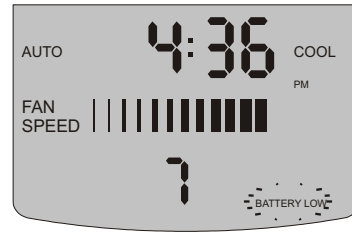

ILL1106-A

To change the batteries remove the cover from the back of the remote control. Pull out the old batteries and replace them all with the new ones. Do not mix new batteries with old batteries.

The remote control has 2 minutes of back-up power to retain its memory while the batteries are being changed.

**DIP SWITCHES**

There are 2 rows of DIP switches located under the battery cover on the remote control.

**WARNING: Do not alter DIP switches 1 to 8 on top row and 7 & 8 on bottom row as the cooler will cease to work.**

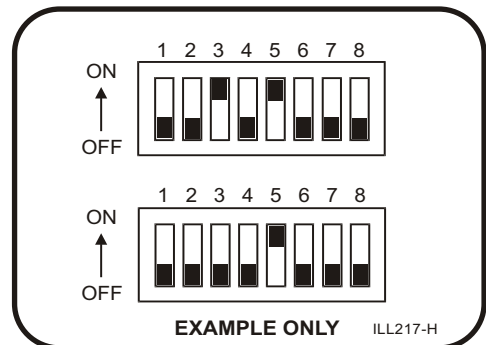

EXAMPLE ONLY ILL217-H

Definition of DIP switch positions (first 6 in bottom row only) are as follows:

**BOTTOM ROW**

- (1)..... Reserved for later use.
- (2)..... OFF, 24 hour clock.  
ON, 12 hour clock.
- (3)..... Not Used
- (4)..... OFF, no pre-cool.  
ON, pre-cool.
- (5)..... OFF, drains 3 days after power off.  
ON, drains 3 hours after power off.
- (6)..... OFF, drains every 65 minutes of operation.  
ON, activates water salinity circuit (WaterManager®).



**STARTING YOUR COOLER**

The  button turns the air cooler on and off.

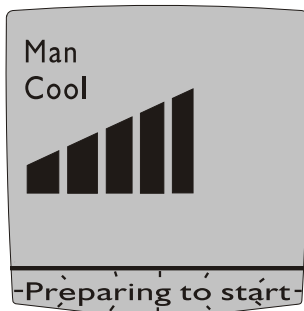

There are two modes of operation to choose from, Automatic mode or Manual mode. When the air cooler is turned on, it will start in the mode of operation it was in when last turned off. If your air cooler has been off for more than (about) 10 minutes, when you start it, "Preparing to Start" may flash on the display as shown. This shows that the water pump will operate to saturate the cooling pads for a few minutes, before the fan is turned on. This ensures that when the fan starts, only cool air enters the building.



ILL1122-A

In Manual mode the cooling level can be manually adjusted.

In Manual mode, press  to choose between circulating cool air or uncooled air. When "Cool" is displayed, fresh cool air will circulate into the building. When "Vent" is displayed as shown, fresh uncooled air will circulate through the building.

Press  to increase the fan speed and circulate more air. Press  to decrease the fan speed and circulate less air. Press once to change the speed by one increment. Hold the button down to change the speed more quickly.

MANUAL COOL DISPLAY

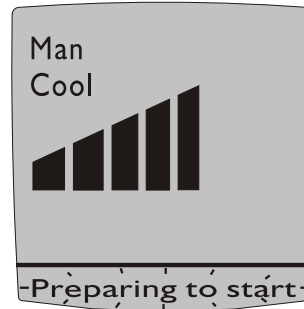

ILL1122-A

MANUAL VENT DISPLAY

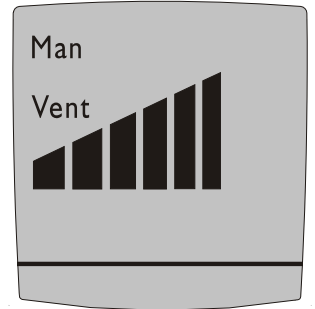



ILL1123-A

**AUTOMATIC MODE**

The  button is used to select Automatic mode or Manual mode. When "Auto" is displayed the cooler is under Automatic control and will operate according to the temperature sensed at the wall control.

When the air cooler is turned on, it will read the temperature and set the cooler operation accordingly. If the temperature increases at the wall control, then the fan speed will increase. As the temperature decreases the fan speed will decrease until the cooler turns off.

Press  or  to override the automatic cooling level setting and adjust your room temperature.



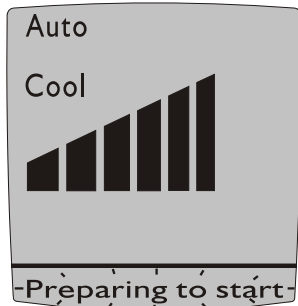







AUTOMATIC MODE DISPLAY



ILL1124-A

**TIMED AUTOMATIC START**

You can set the air cooler so that it will turn on after a set number of hours.

1. To set the delayed start time, press  with the cooler turned **OFF**. "Starting in" will be displayed as shown with the last mode of operation (Manual or Automatic).
2. If you want the air cooler to turn on in Automatic mode with the previous settings, then press  until "Auto" is displayed. Alternatively, if you want the air cooler to turn on in Manual mode, press  until "Man" is displayed, then press  and then  or  to set the required fan speed.
3. To set the time until the start, press .
4. Then press  or  to adjust the time. The cooler can start up to 24 hours in advance.
5. Press  again to initiate the timed automatic start. The timed start will not repeat.

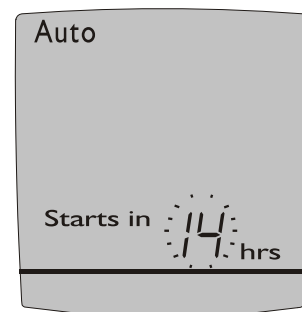





ILL1117-A

**MANUAL MODE**

To switch to Manual mode, press  until "Man" appears in the display. button until MAN is shown on the display.

**TIMED AUTOMATIC STOP**

You can also set the air cooler so that it will turn off after a set number of hours.

1. To set a delayed stop time, press  with the cooler **RUNNING**. "Stopping in" will display.
2. Press  or  to adjust the number of hours before the air cooler will stop. The maximum delay setting is 24 hours.
3. Press  again to begin the timed stop.

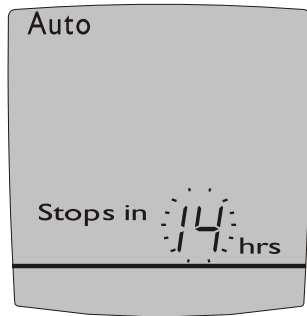



ILL1119-A

**USING THE COOLER**

Now that you have read these instructions, press the  button to turn your air cooler on. If the air cooler has not operated for a while "Preparing to Start" will flash on the display (see page 7). The pre cool cycle will begin and will take only a few minutes to complete. After this time, the fan will start automatically, and you can enjoy the comfort of cool fresh air!



**AIR TOO COLD**

With the cooler running in Automatic mode, you may find that you are too cold or that the air cooler is blowing too much air. Press  to reduce the amount of cooling.

If you are too cold with the cooler running in Manual mode, then press  to reduce the fan speed. You can also circulate fresh uncooled air by pressing  until "Vent" displays.

**AIR NOT COLD ENOUGH**

You may find that with the air cooler running in Automatic mode, you are not cool enough. Simply press  to increase cooling.

If you are not cool enough with the air cooler running in Manual mode, then press  to increase the fan speed. Ensure that cooled air is circulating by pressing  until "Cool" displays.

**You can experiment with the settings on your wall control. This is the best way to decide what suits your needs.**







**DRAIN VALVE**

This air cooler is supplied with an automatic drain that performs two primary functions:

1. It opens and closes automatically to control salt concentrations in the tank.
2. It opens to drain all water and keep your tank dry during prolonged "off" cycles.



Your cooler will automatically change some of the water during operation when the water salinity becomes too high. This ensures the water is always fresh and helps maintain your cooler in good condition to ensure optimum cooling performance. This is called "salinity sensor" method. Alternatively and if necessary, the air cooler can be set to change some water after a set time of cooling operation. The frequency of the automatic drain function may have been adjusted by your installer. This is called "timed drain" method.

You can select either method of water replacement with the following steps.

1. When the cooler is **OFF**, press and hold .
2. While still pressing , press .
3. A number will display which corresponds to the selected salinity control method as shown in the table below. Press  or  to change the displayed number to the desired salinity control method.
4. Press  to set your selection.

Display Number	Salinity Control Method
00	STANDARD Salinity Sensor
01	Timed Drain

When the air cooler is not operated for 72 hours, the drain valve will open automatically to empty all water from the cooler. If necessary, you can adjust this delay time with the following steps.



1. When the cooler is off, press and hold .
2. While still pressing , press .
3. A number will display indicating the current water drain delay time according to the table.

Display Number	Drain Delay Time
00	4 hours
01	1 Day
02	2 Days
03 STANDARD	3 Days
04	4 Days

Press  or  to select your desired delay time.

4. Press  to set your selection.

**DRAIN MODE**

At any time when the wall control is OFF, you can manually drain the cooler by pressing and holding  and  for 1 second. The display will show “dr” to confirm the operation has activated.

**MAINTENANCE**

**WARNING! Maintenance must be carried out by an authorized service agent. Power to the cooler must be disconnected before pad frames are removed or you may risk personal injury.**

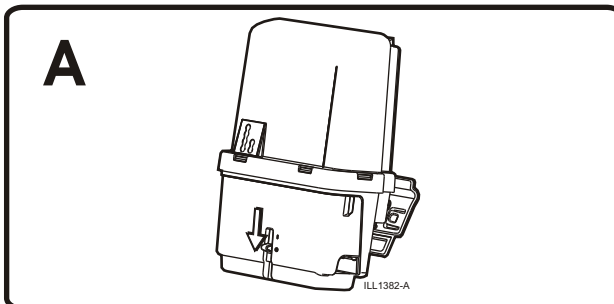

**WARNING! If the supply cord is damaged, it must be replaced by a special cord available from the manufacturer or it's service agent.**

**HEALTH REGULATIONS**

Note that some regulating authorities require servicing to be conducted at specific intervals.

**END OF SEASON SERVICE**

- Turn off the power supply to the air cooler.
- Turn off the water supply to the air cooler.
- Remove the pad frames as shown. (Fig. B)

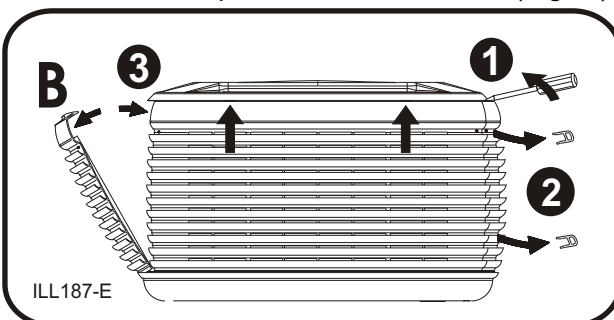

- Turn off power switch inside the cooler. (Fig. A)
- Check and clean the lid water spreaders (Fig. C)

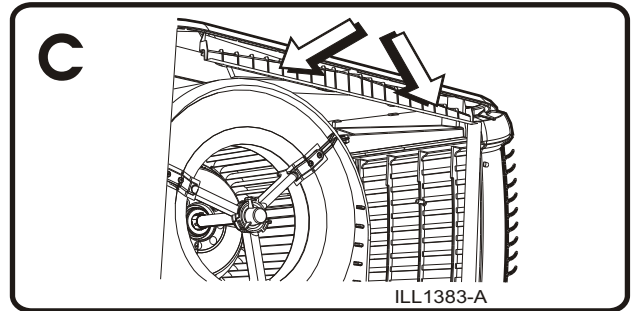

- Thoroughly clean the tank and pump filter.
- Gently wash the pads to remove any dust.
- If freezing conditions can occur at any time, a drain down facility must be provided at the lowest point of the water supply pipe.
- Re-fit the pad frames.

**PRE SEASON SERVICE**

- Turn off the main power supply to the air cooler
- Remove the pad frames as shown.
- Ensure the power switch in the cooler is off.
- Gently wash the pads to remove any dust build up during the winter period. If the pads are in poor condition, replace them.

**IMPORTANT! Do not damage the pads with high pressure water spray.**

- Turn on the power switch inside the cooler.
- Turn on the water and then the main power.
- Re-fit the pad frames and run the cooler.

The pads supplied have been selected to give the highest possible cooling performance. **WHEN REPLACING PADS DO NOT USE ALTERNATIVES.** The manufacturer is not responsible for the performance, damage to, or safety of the air cooler when alternative pads are used. **Using poor quality or incorrect pads may cause water carry-over that might enter electrical components creating an electric shock or fire hazard.**

**REMOVAL OF PAD FRAMES**

To remove a pad frame, insert a flat screw driver tip into the slot as shown and lever until disengagement occurs. Take hold of the pad frame and pull it towards you until the internal side clips disengage. Pivot the pad frame outwards and lift up. Take care not to damage the pad. Repeat these steps for the remaining pad frames. (Fig. B)

### PRE-ASSEMBLY INSPECTION

- Check that the correct cooler has been supplied. The cooler should have the following parts:-  
(Check the parts are inside the cooler by removing a cooling pad frame.)

#### UNIT CONTENTS (Packed inside cooler)

ILL1401-C

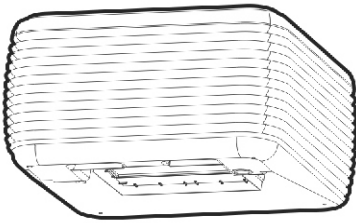

CABINET

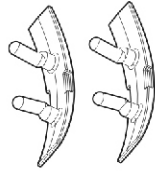

SPARE CORNER CLIPS



OPERATING & INSTALLATION MANUALS, WARRANTY CARD



FOOT MOUNT SCREWS

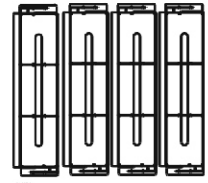

ROOF JACK ADAPTORS

#### MAJOR COMPONENTS (Fitted to cooler)

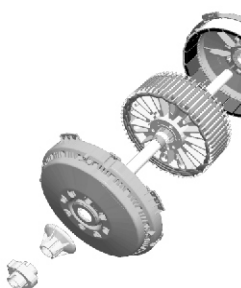

DIRECT DRIVE MOTOR ASSEMBLY

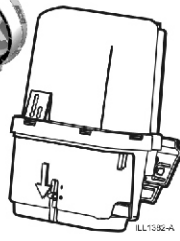

ELECTRONIC MODULE

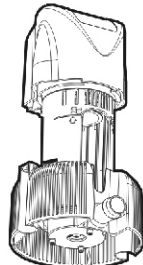

PUMP

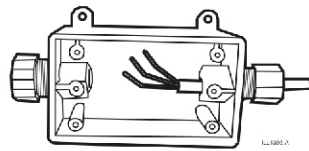

(LID NOT SHOWN)

MAINS POWER ENCLOSURE

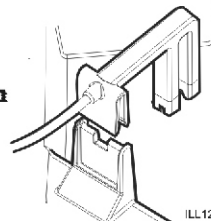

WATER PROBE

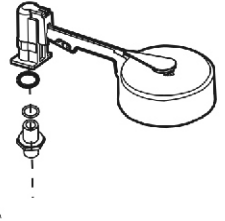

FLOAT VALVE

#### VARIABLE SPEED CONTROL KITS (Supplied separately)

##### HORIZON SENSORTOUCH® REMOTE CONTROL PACKOUT KIT CONTENTS

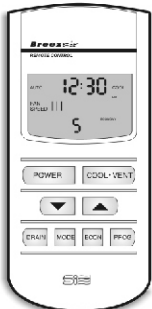

**SENSORTOUCH®**  
REMOTE CONTROL,  
WALL MOUNT PLATE  
& FASTENERS

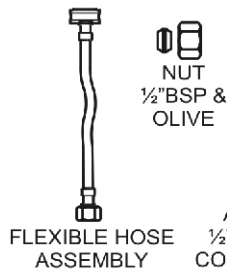

FLEXIBLE HOSE ASSEMBLY



NUT 1/2" BSP & OLIVE



BRASS ADAPTOR 1/2" BSP to 1/4" COMPRESSION



AAA BATTERIES

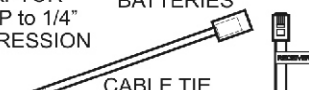

CABLE TIE



RUBBER WASHER

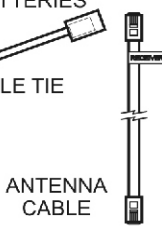

ANTENNA CABLE



RF ANTENNA

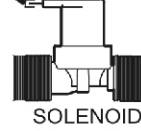

SOLENOID



SCREWS & WALL PLUGS



STRAIGHT TUBE (Water Inlet)

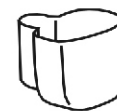

SOLENOID COVER

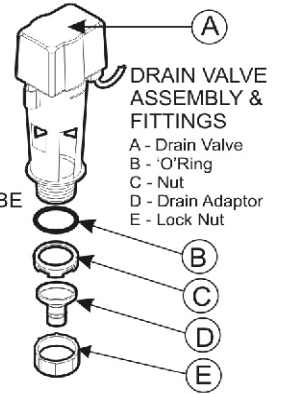

DRAIN VALVE ASSEMBLY & FITTINGS

- A - Drain Valve
- B - O'Ring
- C - Nut
- D - Drain Adaptor
- E - Lock Nut

##### HARMONY SENSORTOUCH® WALL CONTROL PACKOUT KIT CONTENTS



**SENSORTOUCH®**  
WALL CONTROL,  
WALL MOUNT PLATE  
& FASTENERS

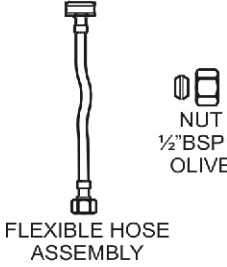

FLEXIBLE HOSE ASSEMBLY



NUT 1/2" BSP & OLIVE



BRASS ADAPTOR 1/2" BSP to 1/4" COMPRESSION

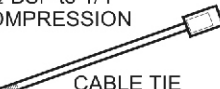

CABLE TIE



RUBBER WASHER



CONTROL CABLE

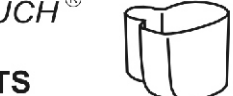

SOLENOID COVER



SOLENOID



SCREWS & WALL PLUGS



STRAIGHT TUBE (Water Inlet)

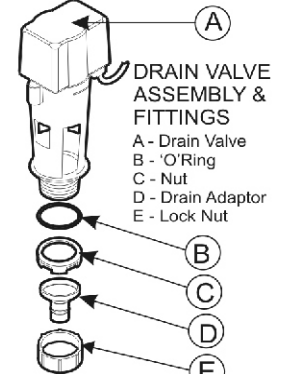

DRAIN VALVE ASSEMBLY & FITTINGS

- A - Drain Valve
- B - O'Ring
- C - Nut
- D - Drain Adaptor
- E - Lock Nut

**UNPACKING THE COOLER**

Cut and remove the shrink wrap from around the cooler. Using 2 people, carefully lift the cooler up and away from it's skid (Fig 1).

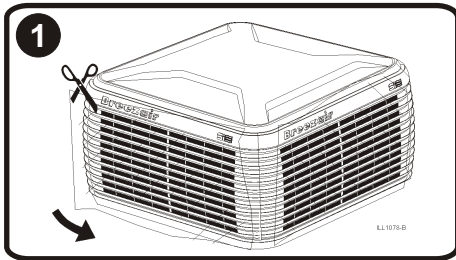

**REMOVING PAD FRAMES**

Firstly remove the corner clips, which are located above the top louvre and third louvre from the bottom on all corner joints. The clips will require a screw driver to aid removal.

Each frame is clipped into the cooler and is removed by use of a medium sized screwdriver. Insert the screwdriver into the small slots at the top of the frame and lever upwards until the clips disengage. The frame is now free to be lifted out of the cooler cabinet (Fig.2).

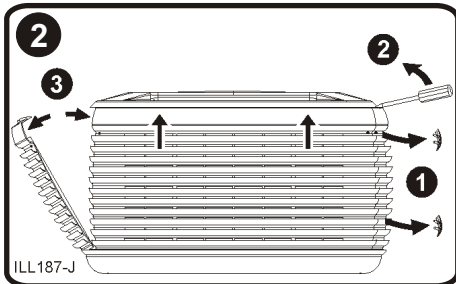

**REPLACING PAD FRAMES**

Ensure the pad frame is the correct way up by checking that the louvres face upwards. Fit the frame in at the bottom along the edge of the pan and rotate it in at the top. Take care not to damage the Chillcel as the frame approaches the plastic water spreader under the top panel. Then two sharp hits by hand should locate the frame into its correct location under the top panel. Replace the pad frame clips at the corners

**COOLER LOCATION**

Check the proposed cooler location first, to ensure it is structurally capable of supporting the weight of the cooler. Polymer coolers are light-weight but they require adequate support. The largest cooler in the EXH range is about 185 lbs (84 Kgs).

Always locate the cooler where there is a plentiful supply of clean fresh air, and not in a recess or close to the ground where the air may be dusty or polluted.

**Keep the cooler away from heater flues, exhaust vents (especially kitchens) and sources of ignition. Avoid dangerous situations.**

Allow for adequate, SAFE access around the cooler for maintenance, especially for pad cleaning, water connections, electrical connections, drain connections.

It is mandatory that water cannot enter the building as a result of poor sealing (caulking or flashing) of the various penetrations into the building (ducts, necks, water pipes, electrical conduits).

The cooler must be mounted at least 10ft (preferably 15ft) away from the closest element of any TV antenna. Make sure the cooler is not between the antenna and the transmission tower that is providing the television signal to the home. Ensure that all antenna cables are at least 10ft from the cooler.

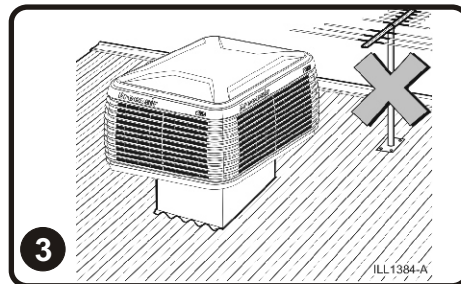

**MOUNTING THE AIR COOLER.**

Handling and installing the cooler is always much easier if you remove the pad frames first.

**New installation, roof jacks**

Use 24 G or stronger metal roof jack. The cooler may then be attached directly to the jack.

**Replacement installation, roof jacks**

Roof Jack recommended wall thickness should be 24 G steel or stronger. The supplied roof jack adaptor may be required to attach the cooler to the existing roof jack.

For assembly of the roof jack adaptor, see Fig. 4.

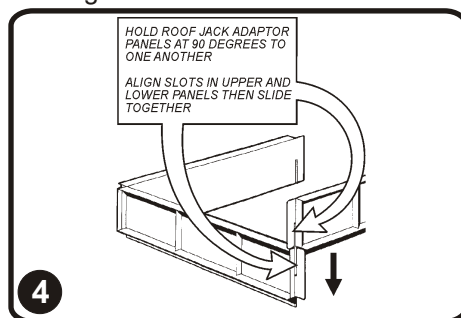

**NOTE!** It is recommended that a strip of foam or sealant is applied to the upper flange on the roof jack before securing the cooler to provide an airtight seal.

Ensure that the top of the roof jack is level, then check the lip of the pan for level when the cooler is in position on the roof jack. (Fig. 5)

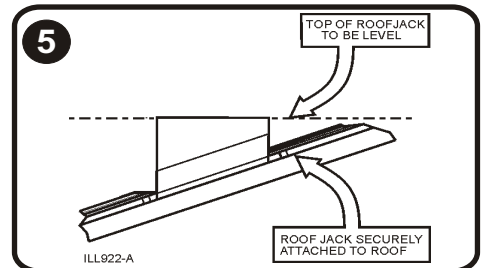

**RAISING COOLER TO IT'S FINAL LOCATION**

**HANDLE WITH CARE. DO NOT DROP.**

For lifting or pulling the cooler, always apply the ropes around the full cabinet or the fan housing and NEVER tie them to any of the four corner posts.

**WARNING!** Take care when moving the cooler that nothing is allowed to penetrate into the discharge opening (such as the end of a ladder), as damage may occur to the internal cooler components. If a ladder is used as a slide for the cooler to be pulled onto a roof or platform, we strongly recommend the cooler be turned upside-down first. Protect the lid from scratching.

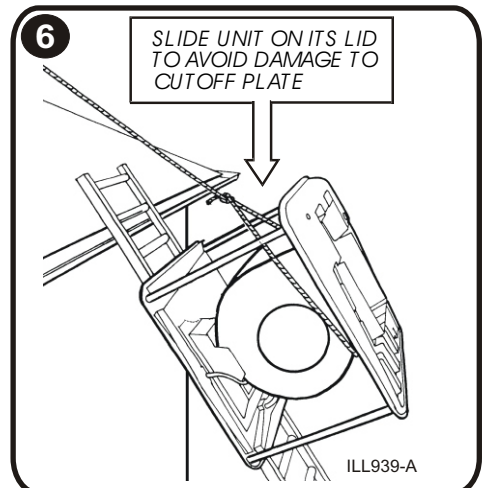

After placing the cooler on the roof jack check that water spreaders and other internal components are all securely in place.

Attach the cooler to the roof jack from inside the cooler (Fig. 6), using 1 1/4" long self-tapping screws. Use a minimum of six (6) screws. In high wind areas or when not using leg supports use a minimum of eight (8) screws, 3 per side and 2 at the front.

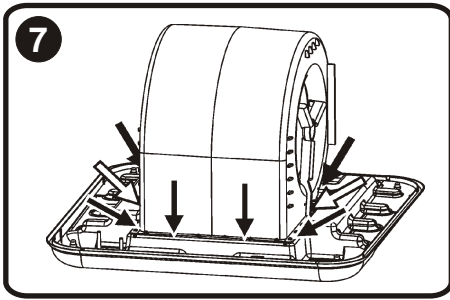

The sump of the pan is designed to be located on the low side of the roof (Fig. 8)

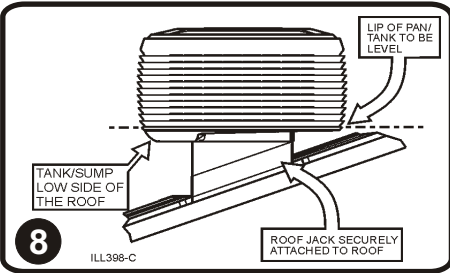

**SECURING LEG SUPPORTS**

After levelling and securing the cooler onto the roof jack you are ready to fix the four leg supports. The telescopic leg supports (with feet attached) slide up and down inside the four cooler corner posts. By removing the screw from the lower end of the corner post you enable the leg support to slide down to roof level. Refer figs 9, 10 & 11 for the procedure for adjusting and securing the leg supports.

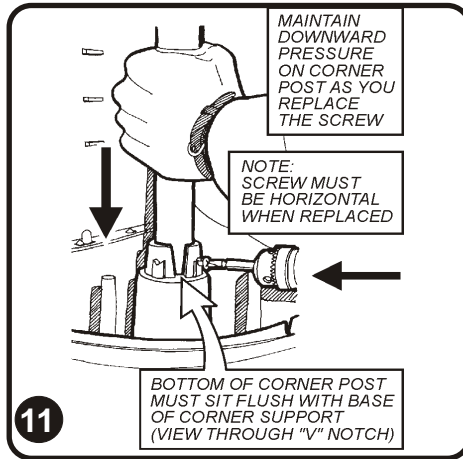
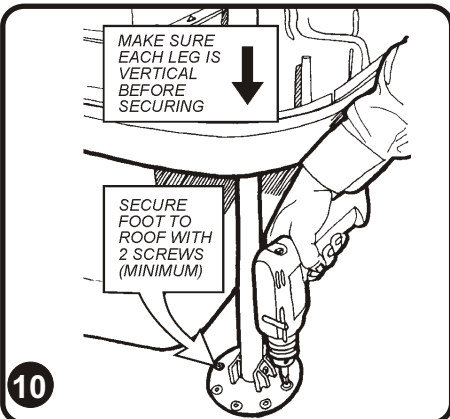
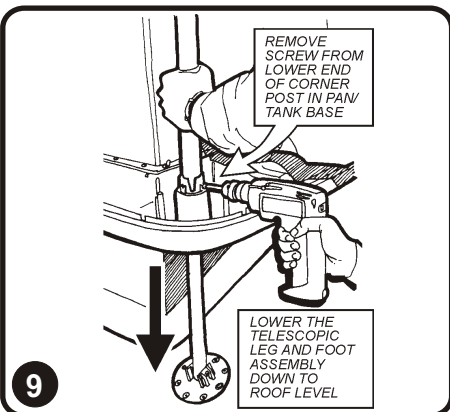

The support legs are not full weight bearing and are only intended for additional support in case of high winds, etc.

**WATER INSTALLATION**

A permanent water supply is required to be connected to the water inlet solenoid valve assembly that is supplied with the cooler. The float valve then controls the water level in the pan automatically. (Fig. 12) The permanent water supply connection point is located underneath the pan, and is attached to the flexible hose and tube assembly. (Fig 14, item "F")

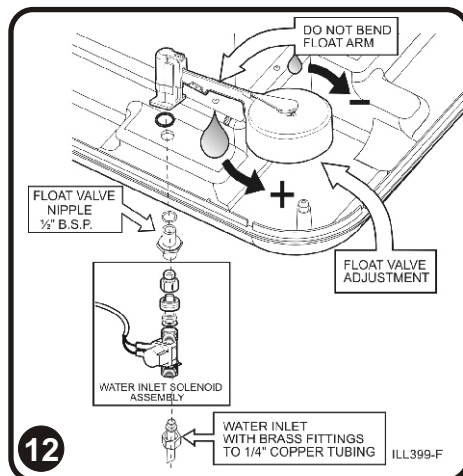

Install a manual water shut-off valve near the point of entry of the water supply to the cooler, in the permanent water supply. In areas subject to winter freezing, install a drain down feature. **DO NOT FIT SHUT OFF VALVES DIRECTLY ONTO THE FLOAT VALVE NIPPLE OR SOLENOID VALVE.**

**WARNING!**

Flush foreign matter from water supply pipe before final connection to the flexible hose, to avoid damage to the water solenoid and float valve.

**INSTALLING THE INLET SOLENOID VALVE**

Fit the inlet solenoid valve under the pan as shown (Fig 14).

Insert the solenoid valve cable through the hole (behind the drain valve) and connect the plugs to the solenoid valve. (Fig. 13) Make sure the cable is fitted to the groove underneath the pan. The electrical cable leads may be connected to the solenoid valve either way around.

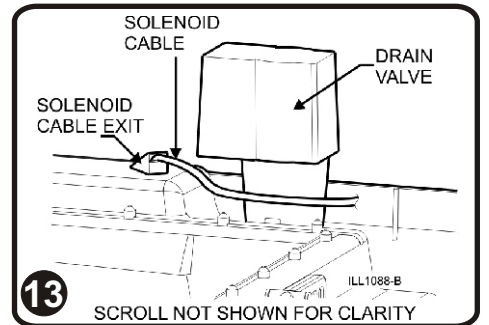

Use thread seal tape between solenoid hose assembly and brass 1/2" BSP to 1/4" compression adaptor or 1/2" BSP Nut.

If freezing conditions can occur at any time, a drain down facility must be provided at the lowest point of the water supply pipe.

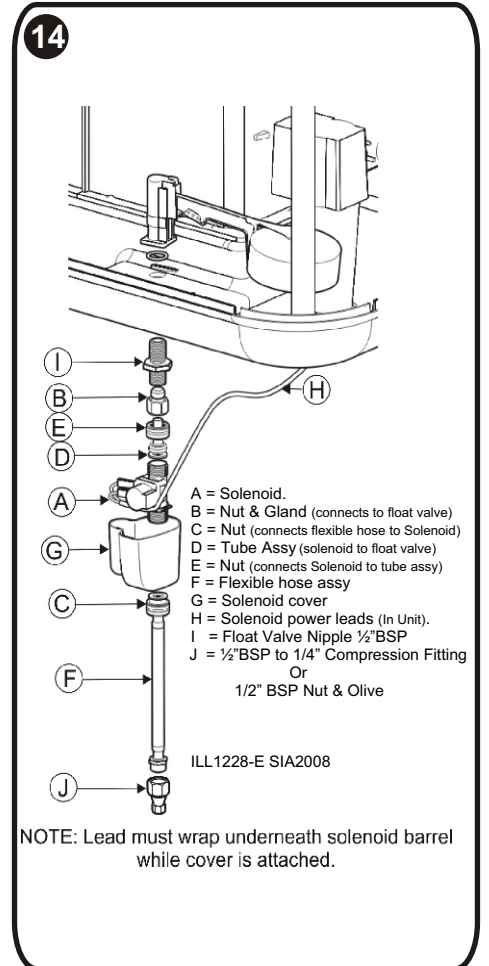

NOTE: Lead must wrap underneath solenoid barrel while cover is attached.

**INSTALLING THE DRAIN KIT**

**It is a requirement of Seeley International - Never drain the water directly on to the roof (This applies to all types of control/drain systems).**

Assemble drain valve as shown (Fig 15).

Make sure that the o-ring is fitted before placing the drain valve into the hole. Screw the nut up tightly by hand underneath the cooler. **Do not over-tighten.** Now connect the cable (Fig 15, item B) to the electronic module.

The drain adaptor allows the attachment of a 3/4" drain hose to run water to a waste point. Attach it to the drain valve fitting underneath the pan by using the drain nut. (Fig. 16)

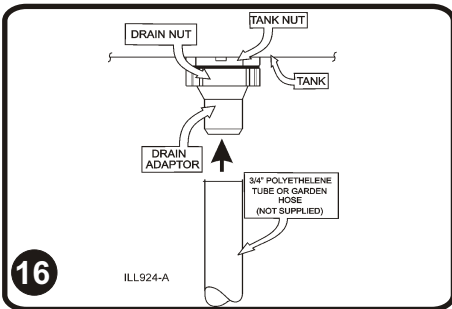
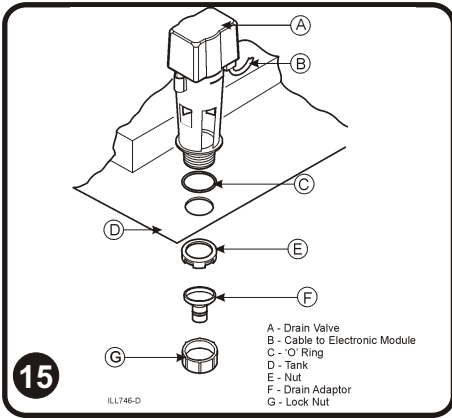

**OPERATING ADJUSTMENTS**  
**Water level:**

The water level in the cooler is important. Adjust the level at the float valve inside the cooler. Rotate the large plastic float CCW or CW to change the level. CW will lower the level; CCW will raise the level. (Fig. 17)

**NEVER ADJUST THE WATER LEVEL WITH THE COOLER RUNNING** because the residual water in the pads and pipes will cause the water to over flow when it runs back into the pan. Water level should be about 1/4" above the float valve support shelf. (Fig. 18)

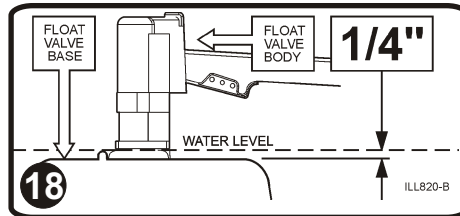
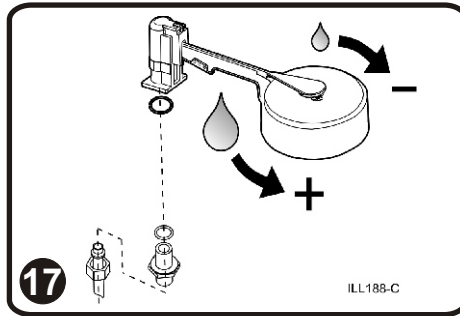

**ELECTRICAL INSTALLATION**

The cooler requires a split phase 240V, 60Hz power supply.

In the termination box connect:

- Phase 1 to the black wire
- Phase 2 to the red wire
- Earth to the green wire

**The electronic module is factory sealed; do not attempt to open it; there are no field serviceable parts inside**

The electronic module contains plug receptacles for fan motor, water pump, and other optional features if used.

Sub-circuit wiring must be rated at cooler rated amperes or higher, and must be protected by a suitable fuse or circuit breaker. Sub-circuit cables are to be double insulated all the way into the main power termination box.

**WARNING!** When retro-fitting the cooler to an existing installation always turn off the electrical power at the source of the wiring. **DO NOT TAKE RISKS!** Turn off and tape over the circuit breaker or remove the fuses and keep them with you until the job is complete. Set cooler, isolator switch, wall switch, motor and pump to "off". Be sure to tell other occupants of the building what you are doing.

**WARNING!** Check to be sure that the voltage rating of the cooler matches your electrical system voltage.

The electrical installation must be carried out by a licensed and qualified electrician.

**INSTALLING THE MAIN POWER CABLES**

The point of entry into the cabinet of the cooler is by knockouts in the pan. Seal the gap between the conduit and knock-out hole with silicone sealant

after making connections and clamping the conduit cable.

Ensure that all electrical connections are tight. Loose connections will cause overheating that may lead to machine damage or fire.

Replace all covers on completion of the work, using only the screws supplied.

Do not tamper with factory wiring.

Before leaving the job, a trained, licensed technician must check that the cooler is operating correctly.

This cooler contains an electronic module with main power supply termination box separated and connected via a cable and plug assembly.

The main power termination box is provided to facilitate easy wiring connections. Cable glands are provided for 1/2" ID conduit. (Fig. 19)

**Running the Wall Control Cable**

Plug the Wall Control cable to point Fig 22 "M" on the electronic controller. Run the cable to the roof space and then to the controller via the mains power cable entry point and plug to the rear of the Wall Control.

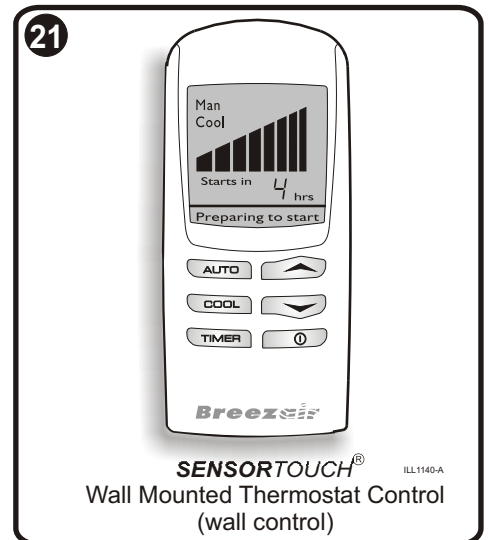
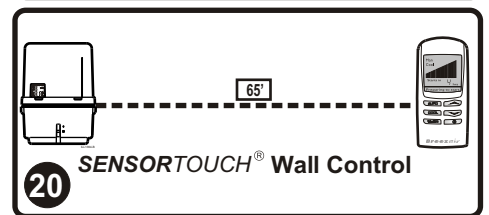
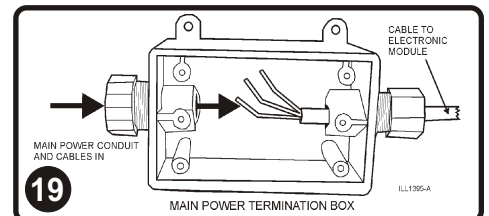

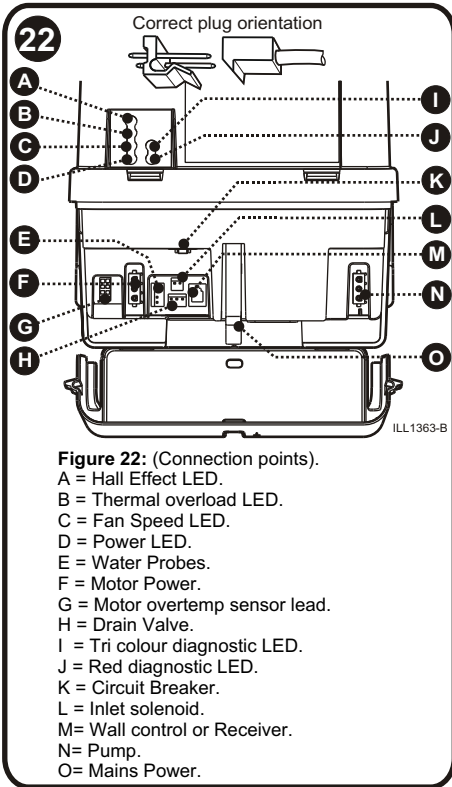

- Do not locate in the direct airflow of the duct outlets.
- Do not locate in strong drafts or in dead spots such as cupboards / drawers.

**INSTALLING THE RECEIVER**

**Note:** The following section describes installation of the receiver, which requires positioning of the receiver external to the cooler, inside the attic or below the ceiling. The supplied receiver lead is 16' (5.0m) long, sufficient to reach into the attic or below the ceiling, from the cooler electronic module.

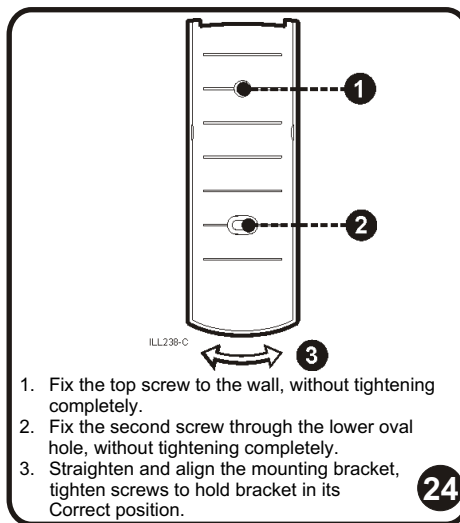

**Running the Receiver Cable**

Plug the receiver cable to point Fig 22 "M" on the electronic controller. Run the cable to the attic space or below the ceiling to the receiver location and plug the 6 pin end (with sticker) to the receiver. (Fig 27)

**Aim to secure the receiver away from the ductwork, but as near as possible to the location of the remote control.**

For installations where the roof is framed in steel, position the receiver between the metal joists keeping the antenna as far away from metal joists as possible and directing the antenna perpendicular (right angle) to the joists will give the best results.

For most installations, mounting the receiver to the roof rafter as shown (Fig 26) will provide satisfactory performance.

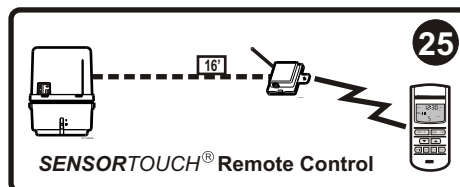

**Other Options for Mounting Receiver**

The standard installation arrangement will satisfy the majority of applications. However you may find difficult cases as follows:

**Signal Problems**

For signal problems in houses with a metal roof, position the receiver as close as possible to the metal roof with the antenna pointing directly away from the roof (Fig 26).

**Flat Roof Installation**

Where the installation is on a building with a flat roof and the attic space is less than 4' (1.2 metres) deep, alternative mounting locations may need to be found for the receiver. For example, install the receiver below the ceiling in the top of a nearby cupboard.

**Do not wrap any excess receiver cable around the receiver. Do not extend the receiver cable.**

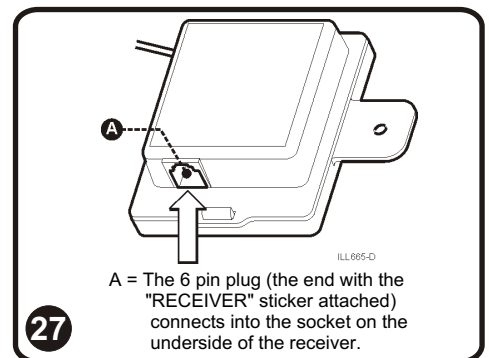
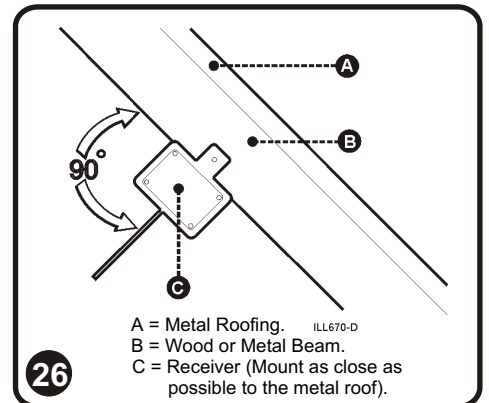

**Important:**

The orientation and position of the receiver may affect the receiver's performance. Other factors that may also influence performance are:

- (1).....Shielding from metal in the attic lying between the receiver and Remote Control. This may include Sisalation/sarking (foil sheets), and ductwork.
- (2).....Reflections from metal around the receiver.

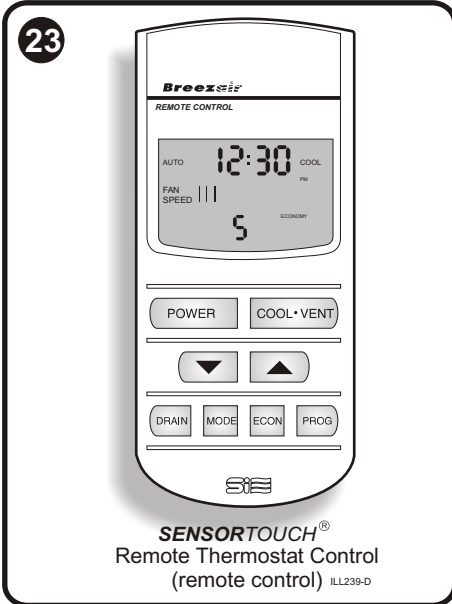

**LOCATING THE REMOTE CONTROL**

The remote control should be placed approximately 5 feet (1.5 metres) above the floor, in the most used room in the home. This will give the optimum temperature sensing and operating position for the user.

Placement is critical for correct functioning of the thermostat (incorporated in the remote control). The following points must be taken into consideration:

- Avoid direct sunlight exposure.
- Avoid mounting on external walls.
- Avoid mounting the remote control near heat sources such as stoves and televisions.



(3).....Interference from nearby transmitters (e.g. mobile phone, AM radio, Television, RF security systems).

**SETTING THE ADDRESS CODE**

The Breezair electronics module will automatically recognize the remote control connection, provided the address code has been correctly set.

This is simply achieved by fitting the batteries into the remote control **within 4 minutes after turning on the main power at the electronics module**. The screen will stay blank for 5 seconds then display "Id" for 1 second. The communication address code will take a few seconds to set, then the remote control can be turned on. (Fig. 28)

If communication cannot be achieved, the power to the cooler will need to be turned off, and the batteries need to be removed from the remote control. Wait until the screen goes completely blank, then repeat the above procedure.

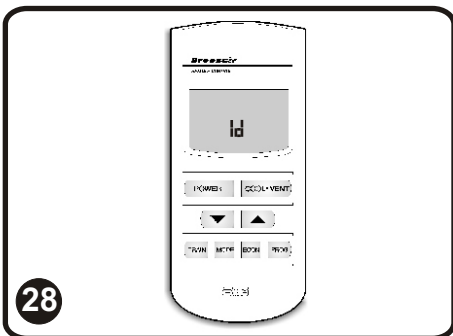

**LOCATION AND TESTING**

**Important!** One of the most critical parts of the installation is the location of the remote control and receiver. If this combination of components are not set up / located correctly, it can result in chargeable service calls.

After the cooler has been installed, place the remote control in the selected wall position and operate the cooler.

Switch the cooler to high speed and switch on and off 20 times at approximately 3 second intervals. 1 missed transmission in 20 is acceptable, 2 missed transmissions is not. This procedure is done to check that the location you have chosen is not prone to interference or blocks the radio transmission. If the operation is intermittent, try another location.

**COMMISSIONING USING THE REMOTE CONTROL**

Take the remote control to the roof and control the Cooler from there. This will save you a lot of time.

Power up the cooler using the on / off switch on the Electronics Module. Test motor and pump operation. Look at the front of the Module where 2 light emitting diodes (LEDs) are situated (Fig. 22 I & J). The top LED is "tricolour" and can glow green, red or amber. The bottom LED is red only. If the top LED (Fig. 22, item I) is double flashing green, everything is OK, this is normal operation.

**The following information allows quick diagnosis at start up -**

**The "Tricolour (top) LED" acts as a general diagnostic indicator, and will function as follows:**

- **Green double flash every 2 seconds** indicates the control is running normally. If it does not glow at all, then there is either no power to the Electronics Module (check isolating switch, circuit breaker, plug and socket connections), or a failure has occurred.
- **Amber for 1 second** ( **SENSORTOUCH®** controls only) indicates that the Electronics Module has received a command at an incorrect ID address. (See the **SENSORTOUCH®** remote control - setting address code section above, to re establish the code)

• **Red flashing** indicates one or more of the following faults:

- 1 Red Flash** indicates ....Fault Code #1 – Communication Failure.
- 2 Red Flashes** indicates ....Fault Code #2 – Failure to Detect Water at Probes.
- 4 Red Flashes** indicates ...Fault Code #4 – Failure to Clear Probes during drain.
- 7 Red Flashes** indicates ....Fault Code #7 - Incorrect Main Power Supply Frequency.

**The "Red (bottom) LED" indicates the status of the WaterManager measurement circuit and will function as follows:**

- 1 Flash** indicates ....WaterManager is operating and the measured salinity is below the set point.
- 2 Flashes** indicates ....WaterManager is operating and the measured salinity is above the set point.
- 3 Flashes** indicates ....The Salinity Control Method = Drain every 65 minutes.
- 4 Flashes** indicates ....Incorrect Salinity Control Method selected.

**Continuously On** indicates: The probes are open circuit, or measured salinity is less than 20us/cm (the water is very pure, ie has very little salt content).

**DIP SWITCHES**

There are 2 rows of DIP switches located under the battery cover on the remote control.

**WARNING: Do not alter DIP switches 1 to 8 on top row and 7 & 8 on bottom row as the cooler will cease to work.**

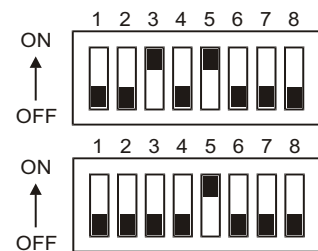

EXAMPLE ONLY ILL217-H

Definition of DIP switch positions (first 6 in bottom row only) are as follows:

- (1) Reserved for later use.
- (2)  OFF, 24 hour clock.  
 ON, 12 hour clock.
- (3) Not Used
- (4)  OFF, no pre-cool.  
 ON, pre-cool.
- (5)  OFF, drains 3 days after power off.  
 ON, drains 3 hours after power off.
- (6)  OFF, drains every 65 minutes of operation.  
 ON, activates water salinity circuit (WaterManager).



**TESTING THE COOLER**

Once you are satisfied that the cooler is installed and commissioned correctly, it is important to run the cooler and ensure that everything is working as it should.

Try turning the cooler on and off with the remote control in all of the rooms in the house. This will make sure that the receiver is located correctly.

Check that the cooler runs quietly and with a balanced distribution of air to all outlets.

Make sure there are no water leaks.

Initiate a drain of the pan by pressing the **DRAIN** drain button on the remote control or  &  button together on Wall Control.

Check the drain fittings and pipes, making sure there are no leaks.

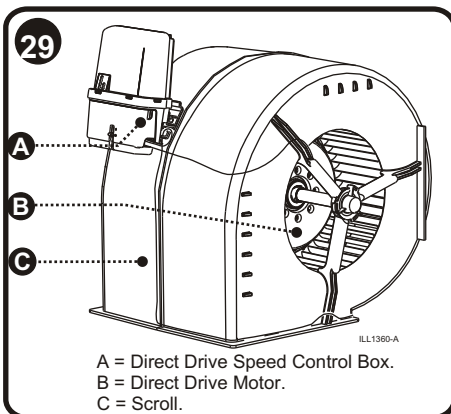

**DIRECT DRIVE MOTOR**

This Breezair cooler incorporates the revolutionary Seeley electronically commutated direct drive motor.

No setup is required for this motor, it automatically adjusts to provide optimum performance for the installation.

This new direct drive system eliminates the need to adjust belts and pulleys. There is no need to set motor current and low speed.

Please familiarize yourself with the LED display (Fig 30), to ensure that the system is running as intended when you have installed the cooler.

**Component location**

All Breezair coolers are fitted with a main cooler control box (Fig 29 - A).

**Note!** The control box cover will only open and close with the ON / OFF switch in the "OFF" position. Do not try to force the cover open with the switch in the "ON" position.

**Note!** Take care to position the cables into the cover slots when closing, so that they do not become caught or pinched. The direct drive motor (Fig 29 - B) is situated inside the fan scroll assembly (Fig 29 - C).

**Electrical Connections**

The motor and control box will arrive assembled and connected. All coolers are factory tested.

Refer to figure 30 for the correct connection points and corresponding components if necessary.

**Note!** The control box is a non-serviceable part. Do not open or attempt to repair any components.

**LED 3** when on (glows green), indicates the motor is rotating at the correct speed for the given setting.

**LED 4** when on (glows green) indicates main power is applied to the motor when the ON button has been pressed.

**Important! Always turn "OFF" main power to the cooler before checking connections or touching wiring and components.**

If some or all of the LEDs are not glowing green, check the connections for the associated components.

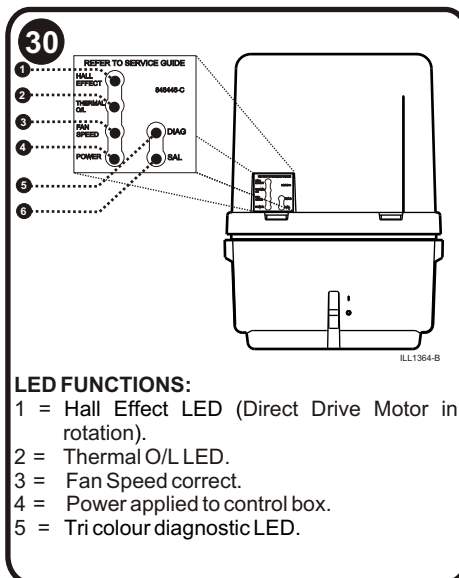

**TESTING THE DIRECT DRIVE SYSTEM**

Turn the cooler on in "Ventilation" mode. The fan only will commence operation.

Observe the LED readout on the top of the Direct Drive speed control box (Fig 30). LEDs 1 - 4 should be on (glowing green).

**LED 1** when on (glows green), indicates the direct drive motor is rotating.

**LED 2** when on (glows green), indicates the motor temperature sensor is working, and the motor is operating within its temperature range.

Owners Name: \_\_\_\_\_

Telephone: \_\_\_\_\_

Address: \_\_\_\_\_

Dealer: \_\_\_\_\_

Installer: \_\_\_\_\_

Date Installed: \_\_\_\_\_

Model No.: \_\_\_\_\_

Serial No.: \_\_\_\_\_

Motor Type: \_\_\_\_\_

Motor Power: \_\_\_\_\_

- Cooler level and secure.
- All roof work properly sealed.
- Ductwork and air distribution checked and outlets correctly set.
- All wiring complete.
- Control switch correctly installed.
- Motor and pump correctly plugged into sockets.
- Drain/overflow fitting correctly installed.
- Water level and float adjustment checked.
- Pump runs and water evenly distributed to all cooling pads.
- All control functions checked.
- Owner instructed on correct operating procedure and supplied with operating instructions.

**REMOTE CONTROL DIP SWITCHES**

Record the dip switch settings for this cooler below (if applicable)

**WARNING: Do not alter DIP switches 1 to 8 on top row and 7 & 8 on bottom row as the cooler will cease to work.**



EXAMPLE ONLY ILL217-H

Definition of DIP switch positions (first 6 in bottom row only) are as follows:

- (1) Reserved for later use.
- (2)  OFF, 24 hour clock.  
 ON, 12 hour clock.
- (3) Not Used
- (4)  OFF, no pre-cool.  
 ON, pre-cool.
- (5)  OFF, drains 3 days after power off.  
 ON, drains 3 hours after power off.
- (6)  OFF, drains every 65 minutes of operation.  
 ON, activates water salinity circuit (WaterManager).

Signed by Installer: .....  
Dated: .....

**SERVICE ENQUIRIES:**  
Contact your local Dealer or Installer for assistance.

PROBLEM	PROBABLE CAUSE	SUGGESTED REMEDY
Inadequate Cooling	Under-sized cooler.	Replace with larger cooler.
	Under-sized ducts.	Replace with larger ducts.
	Clogged or dirty cooling pads.	Clean or replace pads.
	Dry pads or lack of water while cooler is operating.	Check water distribution system for possible obstruction in hoses. Check pump.
	Insufficient air discharge openings or inadequate exhaust from building, causing high humidity and discomfort.	Make sure there is adequate provision for exhausting stale air from building (open windows and doors).
	Excessive resistance from poorly located backdraft damper.	Remove backdraft damper and substitute manual slide damper.
	Excessive ambient humidity (see also item above re inadequate exhaust).	On days during summer when ambient humidity is high the cooler will not reduce the temperature as much as on drier days. There is no remedy except to shut off the pump.
Noisy cooler.	Fan out of balance due to dirt. etc.	Clean the fan.
	Air distribution system creating too much back pressure, or changes of direction too sudden, or grilles too small.	Have contractor re-evaluate his design; use bends instead of elbows; change grille sizes.
Pump fails to operate.	Pump circuit breaker tripped.	Check pump for faults. Replace if necessary.
	Pump motor failure.	Replace pump.
Fan fails to start.	Main power circuit breaker tripped or fuse blown.	Check cause of overload. Reset circuit breaker or replace fuse. Adjust motor amp setting if necessary.
	Fan motor burned out.	Replace motor.
	Low system voltage.	Consult with power supply authority.
	Check fault condition via the tri-colour LED on electronic module.	Rectify fault as indicated and restart the cooler. (Refer Pg. 15-16)
	Controller failed.	Replace controller.

**PROBLEM**

**PROBABLE CAUSE**

**SUGGESTED REMEDY**

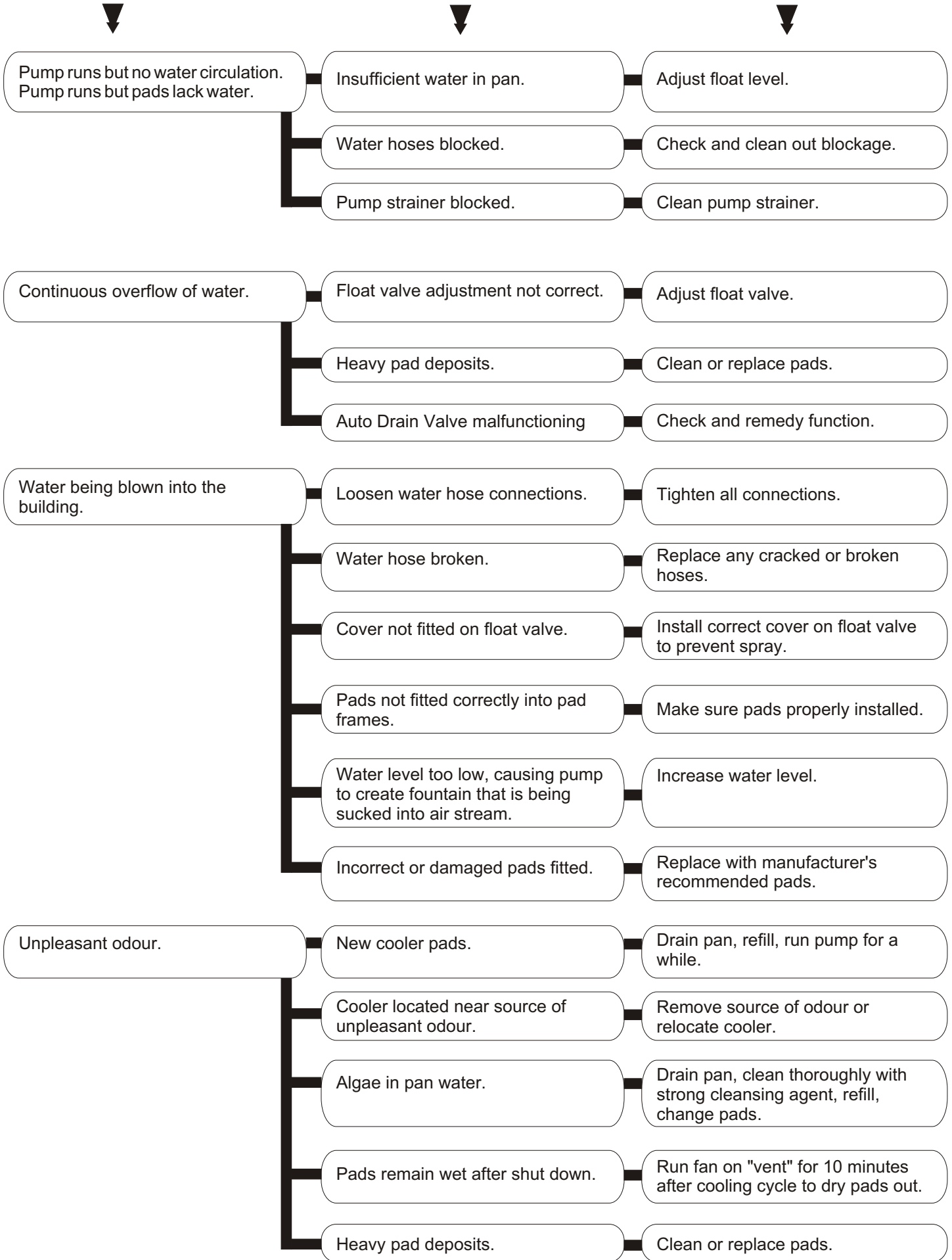

*BREEZAIR COOLER*

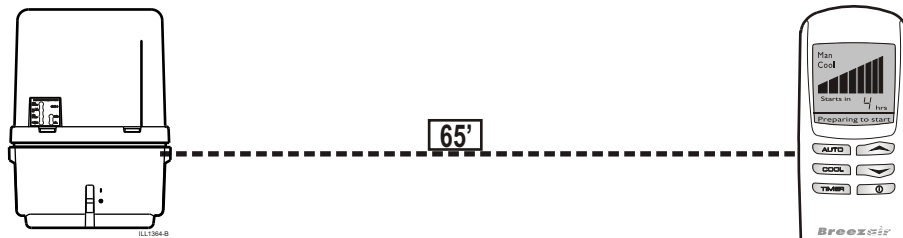
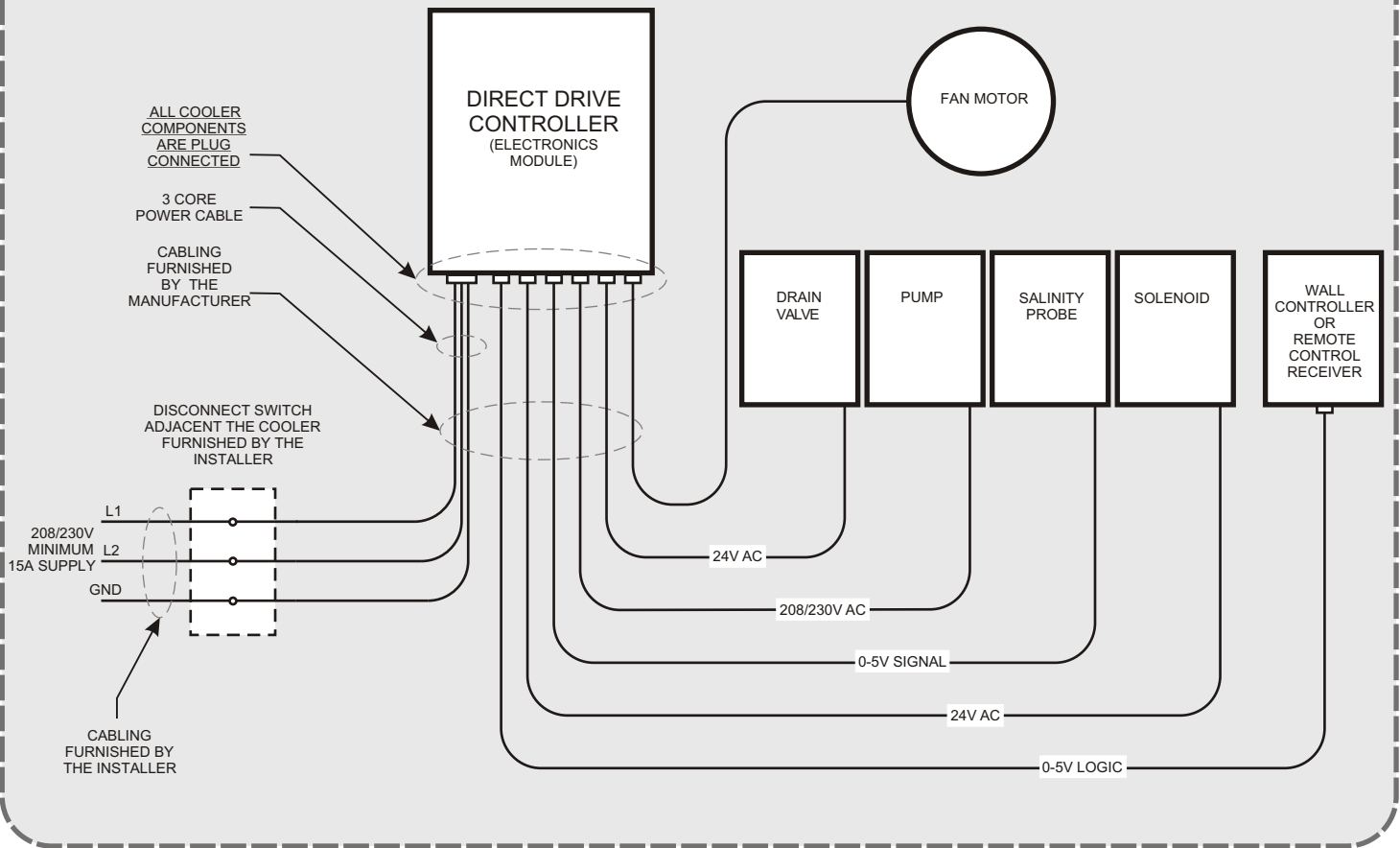

**SENSORTOUCH<sup>®</sup> Wall Control**

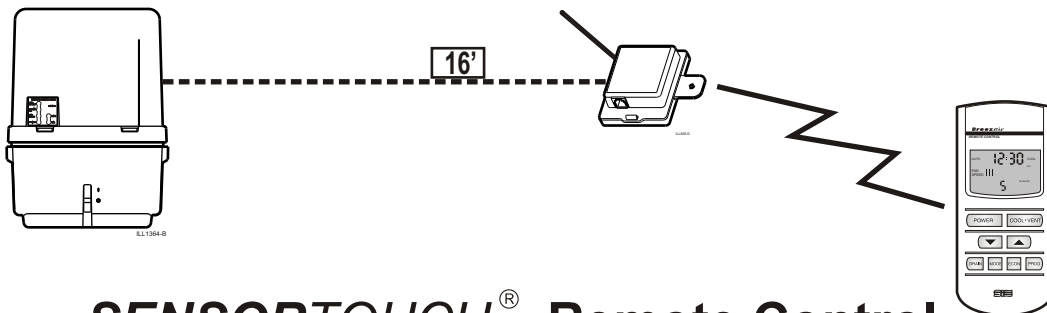

**SENSORTOUCH<sup>®</sup> Remote Control**





Seeley International (Americas)

Phone: 602-353-8066  
Fax: 602-353-8070  
Toll Free: 1-800-926-6824  
[www.convaircooler.com](http://www.convaircooler.com)