

This Owner's Manual is provided and hosted by [Appliance Factory Parts](#).



WHIRLPOOL GL3030WL1 Owner's Manual

[Shop genuine replacement parts for WHIRLPOOL
GL3030WL1](#)



[Find Your WHIRLPOOL Dryer Parts - Select From 3706 Models](#)

----- Manual continues below -----

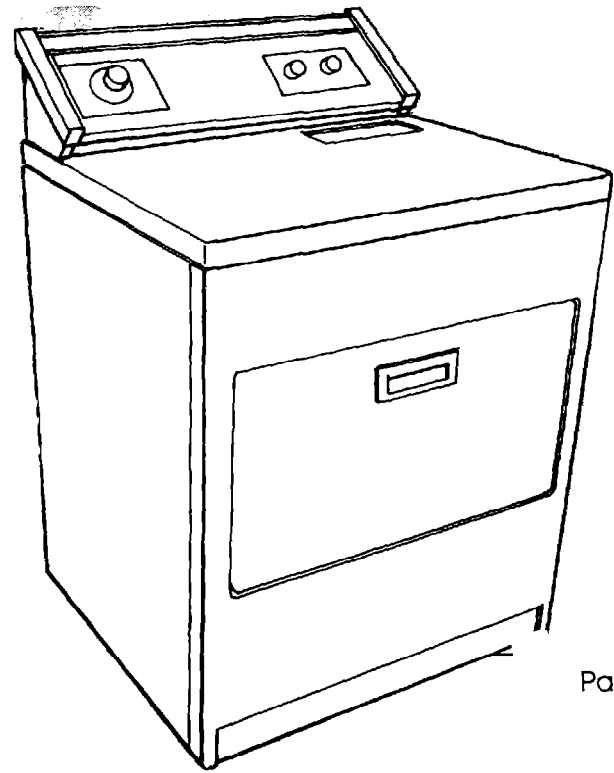

Pa

IMPORTANT:
Read and save
these instructions.

IMPORTANT:

Installer: Leave Installation Instructions with the homeowner.

Homeowner: Keep Installation Instructions for future reference.

Save Installation Instructions for local electrical inspector's use.

Gas Dryer

Before you start...

⚠ WARNING

Fire Hazard

For your safety the information in this manual must be followed to minimize the risk of fire or explosion or to prevent property damage, personal injury or loss of life.

- Do Not store or use gasoline or other flammable vapors and liquids in the vicinity of this or any other appliance.
- WHAT TO DO IF YOU SMELL GAS
 - Do Not try to light any appliance.
 - Do Not touch any electrical switch; Do Not use any phone in your building.
 - Clear the room, building or area of all occupants.
 - Immediately call your gas supplier from a neighbor's phone. Follow the gas supplier's instructions.
 - If you cannot reach your gas supplier, call the fire department.
- Never install dryer up against draperies or curtains or on carpet.
- Keep any and all items from falling or collecting behind the dryer.

Installation and service must be performed by a qualified installer, service agency or the gas supplier.

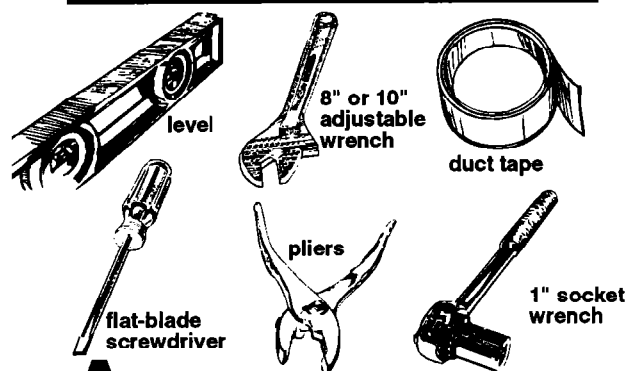

A. You need these tools to install your gas dryer. Get them together in one place to keep track of them.

B. Check the spot where you're going to install the dryer... proper installation is your responsibility. The dryer must not be installed or stored in an area where it will be exposed to water and/or weather.

C. Make sure you have everything necessary for proper installation.

- **Code requirements:** Some codes keep from or limit installation of clothes dryers in garages, closets, mobile homes and sleeping quarters. (Check with your local building inspector.)

⚠ WARNING

Fire Hazard

If you install the dryer in a garage, car port, or areas near vehicles where fumes from gasoline or other flammable materials may be present, the vapors may be heavier than air and remain near floor. Place dryer a minimum of 18 inches above floor. Check with your building

Size: Must be large enough to fully open dryer door. For recessed or closet installation spacing, see back cover.

Support: The floor must be able to support the appliance weight of 175 pounds.

Level floor: Maximum floor slope under dryer — 1 inch.

Protection from the weather: Proper operation of dryer cycles requires temperatures above 45°F., or the dryer may not shut off when automatic cycles are used.

This appliance is suitable for mobile home installations. The installation of the dryer must conform to the Manufactured Home Construction and Safety Standard, Title 24 CFR, Part 3280 (formerly the Federal Standard for Mobile Home Construction and Safety, Title 24, HUD, Part 280).

For mobile home use, this appliance MUST be fastened to the floor and MUST be exhausted to the outside. Order Mobile Home Installation Kit No. 346765 from your dealer. Kit includes the necessary fastening hardware and detailed installation instructions. Exhaust system hardware is also available through your dealer.

This installation must conform with American National Standard, National Fuel Gas Code ANSI Z223.1 — latest edition, and all local codes and ordinances.

Input ratings shown on the serial/rating plate are for elevations up to 2,000 feet. For elevations above 2,000 feet, ratings are reduced at a rate of 4% for each 1,000 feet of sea level.

Gas supply requirements

⚠ WARNING

Fire Hazard

- This dryer must be connected to a regulated gas supply. Failure to do so could cause high-pressure gas release, resulting in a fire or explosion.
 - Have the L.P. gas checked by a qualified person before installing the dryer. The L.P. gas supply must not exceed a pressure of 13" water column.
 - New flexible tubing should be used. Reusing old flexible tubing might result in possible leaks or fire hazard.
- Failure to follow these instructions may result in fire or explosion.

OBSERVE ALL GOVERNING CODES AND ORDINANCES.

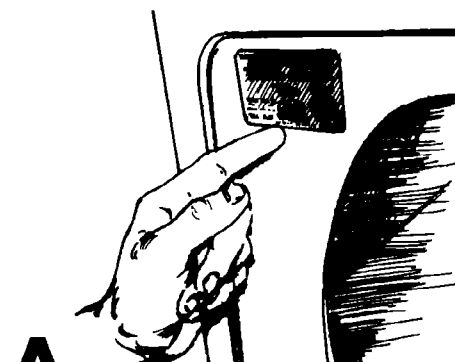

A. First make certain that this dryer is

to dryer



D.

with a... located... should... opening... to shut...

E.

area su... closet, air for a... govern... refer to... covering... instruct...

F.

recom... tubing, Gas As... applian... pipe w... of the a... thread...

G.

supply fittings in-line a...

H.

cabine... the dry... adequ... combu... installa... for min...

I.

For servicing should...

J.

access... be insta... gas sup...

Electrical requirements

⚠ WARNING

Electrical Shock Hazard

- Electrical ground is required on this appliance.
- If cold water pipe is interrupted by plastic, non-metallic gaskets or other insulating materials, Do Not use for grounding.
- Do Not ground to a gas pipe.
- Do Not modify the power supply cord plug. If it does not fit the outlet, have a proper outlet installed by a qualified electrician.
- Do Not have a fuse in the neutral or grounding circuit. A fuse in the neutral or grounding circuit could result in an electrical shock.
- Do Not use an extension cord with this appliance.
- Check with a qualified electrician if you are in doubt as to whether the appliance is properly grounded.

Failure to follow these instructions could result in serious injury or death.

If codes permit and a separate grounding wire is used, it is recommended that a qualified electrician determine that the grounding path is adequate.

A 120-volt, 60-Hz, AC-only, 15- or 20-ampere fused electrical supply is required. Time-delay fuse or circuit breaker is recommended. It is recommended that a separate circuit serving only this appliance be provided.

Recommended grounding method

For your personal safety, this appliance must be grounded. This appliance is equipped with a power supply cord having a 3-prong grounding plug. To minimize possible shock hazard, the cord must be plugged into a mating 3-prong grounding-type wall receptacle, grounded in accordance with the National Electrical Code, ANSI/NFPA 70 — latest edition, and all local codes and ordinances. If a mating wall receptacle is not available, it is the personal responsibility and obligation of the customer to have a properly grounded 3-prong wall receptacle installed by a qualified electrician.

3-prong grounding - type wall receptacle

3-prong grounding plug

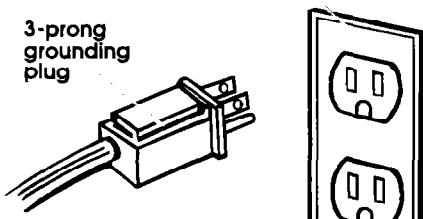

Exhaust requirements

⚠ WARNING

Fire/Health Hazard

- Do Not use non-metal, flexible duct.
- Do Not use metal duct smaller than four inches in diameter.
- Do Not Use exhaust hoods with magnetic latches.
- Check that exhaust system is not longer than specified. Exhaust systems longer than specified will:
 - Accumulate lint.
 - Shorten the life of the dryer.
 - Reduce performance, resulting in longer drying times and increased energy usage.

Failure to follow specifications may result in a fire.

- Do Not exhaust dryer into a chimney, furnace cold air duct, attic or crawl space, or any other duct used for venting.
- Clean the exhaust system every other year.
- Do Not install flexible duct in enclosed walls, ceilings or floors. Accumulated lint could result in a fire or cause moisture damage.
- Exhaust the dryer outside to prevent exposure to substances in the gas fuels and combustion which may be harmful to your health.

The moisture and lint indoors may cause:

- FIRE HAZARD from lint collected in dryer;
- Moisture damage to woodwork, furniture, paint, wallpaper, carpet, etc.
- House cleaning problems and possible health problems.

Failure to follow these instructions could result in fire damage or personal injury.

Use duct tape to seal all joints.

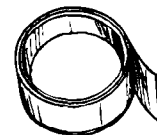

For mobile home installation, the dryer must have an outside exhaust. If you exhaust the dryer through the floor and the area under your mobile home is enclosed, the exhaust system **must** terminate outside the enclosed area. Extension beyond the enclosure will prevent lint and moisture build-up under the mobile home.

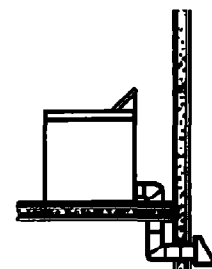

The exhaust duct can be routed up, down, left, right or straight out of the back of the dryer. Detailed space requirements can be found in "Recessed and closet installation instructions" on the back cover.

The ex...
cente...
Detail...
in the...
instruc...
panel...

The m...
deper...
numb...
hood...
and fl...



NUMBER 90° TURN

0
1
2
3
4
0
1
2
3
4

The Maxi...
with 2 elb...

For ex...
exhau...
Part N...
parts...
Service...
exhau...
inches...
incline...
exhau...

Now start...
with dryer in laundry area.

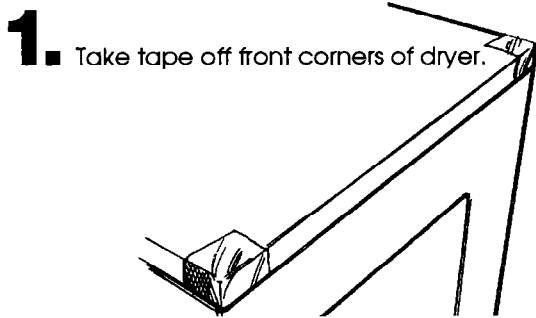

2. Open dryer and remove the literature and parts packages. (If dryer has a drying rack it should be removed also.) Remove all parts from the plastic packages. Line these up next to your tools so each part is there when you need it. Check to see that you have these parts:

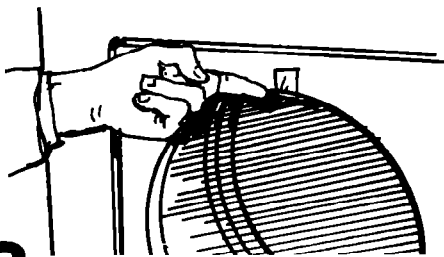
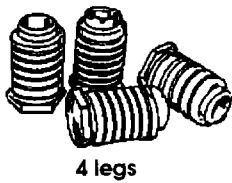

3. Remove the tape that holds the drum to the cabinet. (Some dryer drums are not taped for shipping.) Move the drum by hand to make certain all tape has been removed. Wipe the interior of the drum thoroughly with a damp cloth before using the dryer.

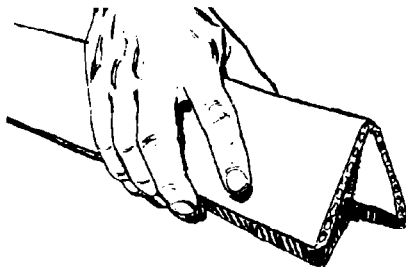

4. Take two of the cardboard corners from the carton and place them on the floor in back of the dryer.

5. Firmly grasp the body of the dryer and gently lay it on its back on the cardboard corners.

6. With one of the legs in hand, check the ridges for a diamond marking. That's how far the leg is supposed to go into the hole. Start to

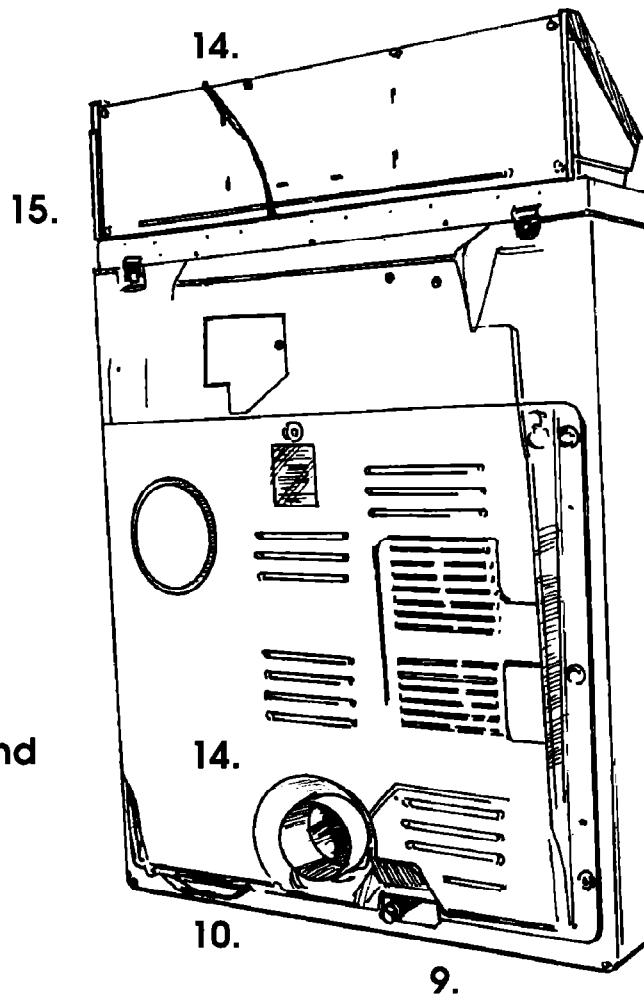
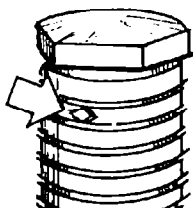

Numbers correspond to steps.

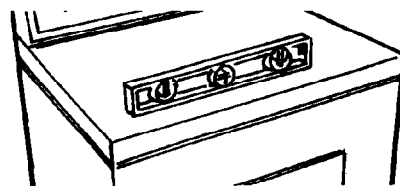

8. Move the dryer close to its final location. To make sure the dryer is level, take a carpenter's level and place it on the top of the dryer, first side to side, then front to back. If the dryer is not level, screw the legs of the dryer up or down to adjust.

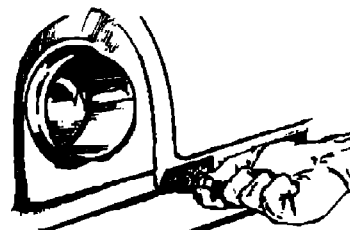

9. Remove the red cap from the gas pipe. Move the dryer into its final position.

10. Connect gas supply to dryer. Use pipe-joint compound resistant to the action of L.P. gas for gas connections. If flexible metal tubing is used, be certain there are no kinks.



13. exhaust... see Exh... require... Conne... duct to... hood... tape in... joints in... compo... around

14. the po... cord in... ground

15. dryer o... air from... supply... full hea... the air... dryer ru... five mi... burner... heat in... five mi... shutoff... five-mi

Recessed and closet installation instructions

! WARNING

Fire/Health Hazard

- Exhaust the dryer to the outside to prevent exposure to substances in the gas fuels and combustion which may be harmful to your health.
 - If dryer is installed in a closet, the dryer MUST be exhausted outside.
- Failure to do so may result in a fire.

The following installation spacings and door air openings for the dryer are possible when installed and exhausted as noted. (Spacing as indicated is in inches and is minimum allowable. For ease of installation and service, additional spacing should be considered.)

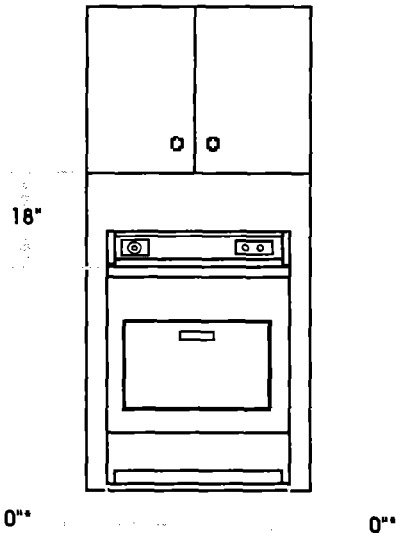

Recessed front view

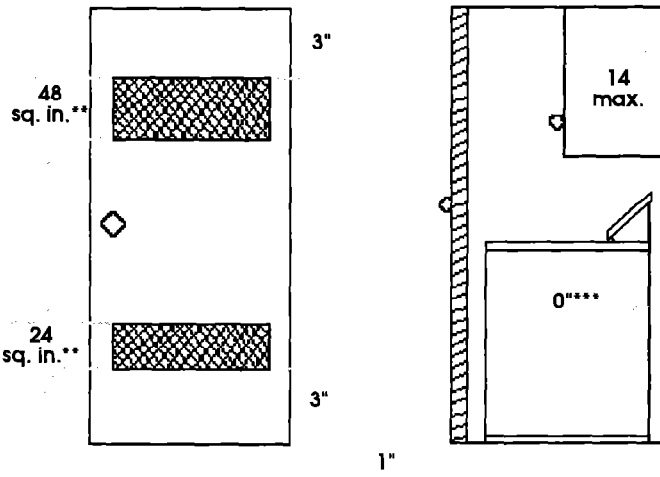

TO PREVENT LARGE AMOUNTS OF LINT AND MOISTURE FROM ACCUMULATING, TO MAINTAIN DRYING EFFICIENCY AND TO PREVENT EXPOSURE TO POSSIBLE HEALTH HAZARDS, THIS MACHINE MUST BE EXHAUSTED OUTDOORS.

- * Additional clearances for wall, door and floor moldings may be required.
- ** Opening is minimum for closet door. Louvered door with equivalent air openings is acceptable.
- *** Additional space is needed when external exhaust elbow is used.

Companion appliance spacings should be considered.

Detailed space requirements can be found on the label located on the back panel of dryer.

NOTE: No other fuel burning appliance may be installed in the same closet.

If dryer operates

If dryer will not operate that:

- Electrical supply is not correct.
- The house circuit breaker is tripped.
- Door is closed.
- Controls are not in correct position.
- Start button is not pushed.
- Gas supply is not correct.

When moving

- Disconnect the dryer from the wall securely to the wall.
- Shut off the gas supply to the gas supply.
- Disconnect the gas supply and cap the pipe.
- Tape the door to the dryer door.
- Tape the dryer gas pipe to the dryer gas pipe.
- Screw leveling feet to the bottom of the dryer.

Before installing the dryer in the home, check the installation instructions with the dealer to see if the correct type of gas in the closet. Information may be found on the plate in the door.

If you need assistance

Check your User Manual for a free number to call for assistance. The dealer to whom you purchased the dryer is listed in the phone directory. When you call, have the model number and serial numbers ready. The numbers are located in the door and on front of the dryer.