

# Eureka 4885AT Owner's Manual

[Shop genuine replacement parts for Eureka 4885AT](#)

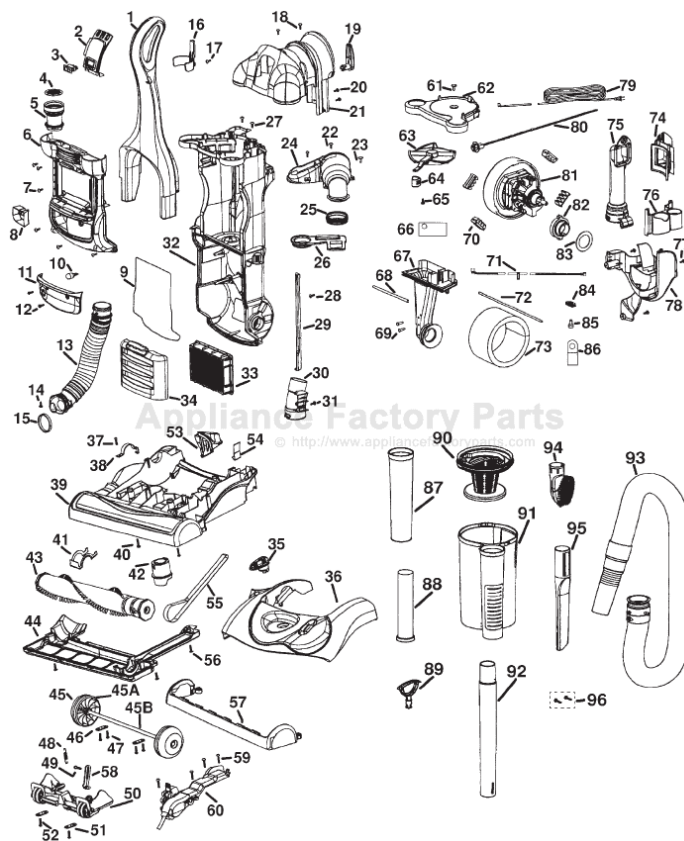

[Find Your Eureka Vacuum Cleaner Parts - Select From 855 Models](#)

----- Manual continues below part list -----

## Available Replacement Parts for Eureka 4885AT

<a href="#">ER-1039</a>	VACUUM BELT AFTERMARKET 1 PACK EUREKA
<a href="#">ER-1882</a>	FILTER, HEPA, UPRIGHTS, 1PK
<a href="#">e-60990-2</a>	BRUSH
<a href="#">E-54943</a>	Spring,

# EUREKA Original & Replacement

LITESPEED CYCLONIC UPRIGHT  
4880AT, 4880BT, 4885AT, 4885BT

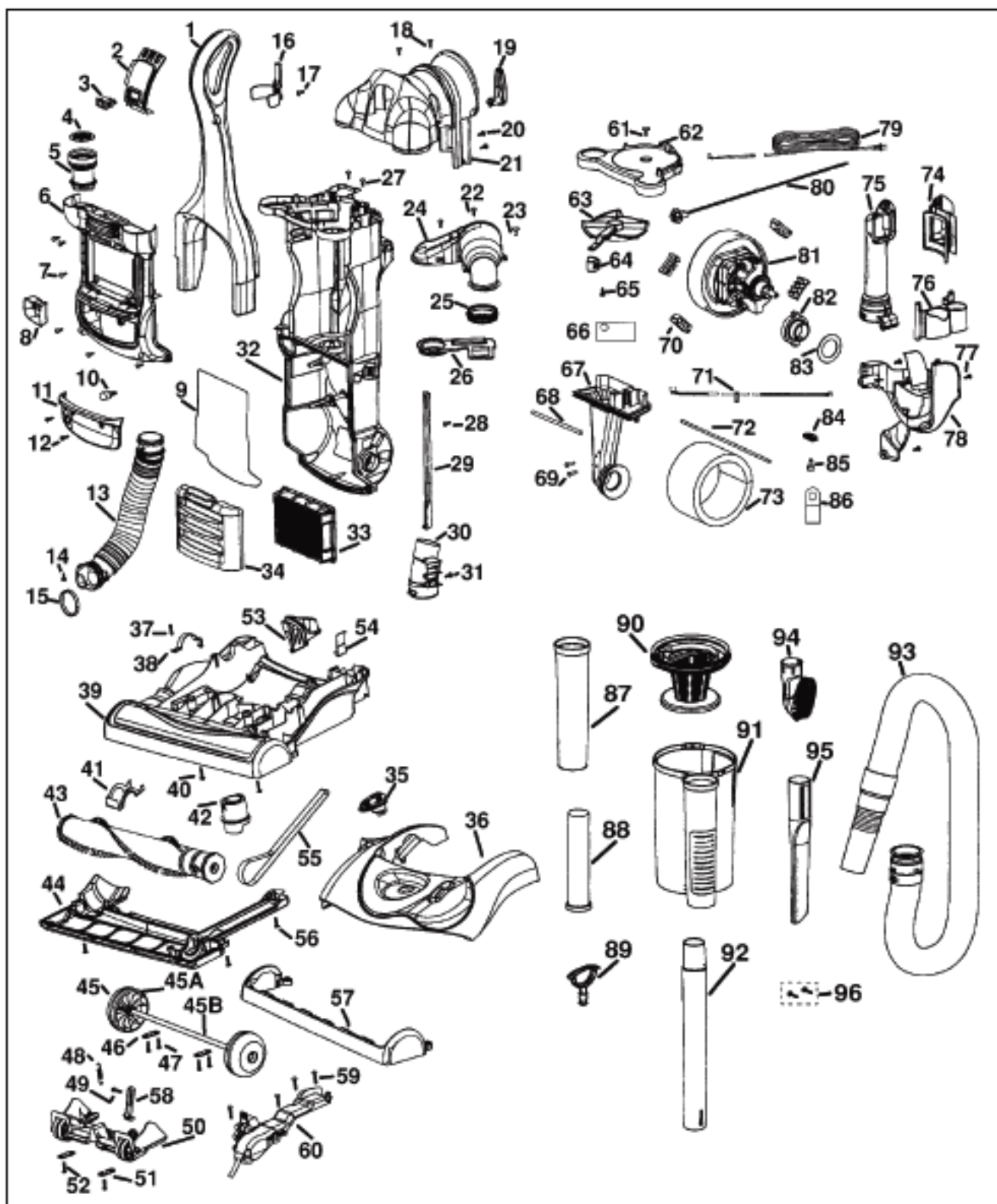

# Original & Replacement **EUREKA**

## LITESPEED CYCLONIC UPRIGHT 4880AT, 4880BT, 4885AT, 4885BT

KEY	PART NO.	DESCRIPTION
1	E-70540-1	Upper Handle Assembly
2	E-70561-313N	Electronics Cover
3	E-20873A	Switch 4880AT
3	E-39455-1	Switch 4880BT, 4885BT
3	E-28073A	Switch 4885AT
4	E-71145	Motor Intake Screen
5	E-70612	Filter Tube Seal
6	E-61773-1	Motor Cover
7	E-53238-27	Screw
8	E-71339	Light Shield
9	E-70055-1	Bag Housing Gasket
10	E-57940-2	Light Bulb
11	E-70552-313N	Lens
12	E-54669-3	Screw
13	E-70588-1	Connector Hose & Adaptor
14	E-53238-27	Screw
15	E-70654	Base Adaptor Seal
16	E-70618-119N	Filter Tube Retainer
17	E-53238-27	Screw
18	E-60160	Screw
19	E-28013-119N	Cord Release
20	E-53238-27	Screw
21	E-70543-355N	Top Cover
22	E-53238-27	Screw
23	E-60160	Screw
24	E-70577	Cyclone Assembly
25	E-70770-119N	Dirt Cup Gasket
26	E-70617-119N	Cyclone Assembly Gasket
27	E-53238-7	Screw
28	E-53238-27	Screw
29	E-70576-119N	Tube Cover
30	E-70546-119N	Adaptor Coupling
31	E-53238-27	Screw
32	E-70550-119N	Rear Housing
33	E-61111	HEPA Filter Style HF2
33	ER-1832	HEPA Filter Style HF2
34	E-70557-3	Filter Cover
35	E-70031-333N	Height Adjustment Knob
36	E-61252-4	Hood
37	E-53238-27	Screw
38	E-38420-2	Clamp
39	E-61253-4	Base Assembly
40	E-53238-27	Screw
41	E-70039	Felt Gasket
42	E-70030-119N	Height Adjustment Actuator
43	E-61250-1	Brushroll
44	E-70024ASV	Bottom Plate
45	E-70026SV	Rear Wheel & Axle Assembly
45A	E70027-119N	Rear Wheel
45B	E-70029-1	Rear Axle
46	E-53201	Clamp

KEY	PART NO.	DESCRIPTION
47	E-53238-11	Screw
48	E-54943	Spring
49	E-60860	Screw
50	E-70034-119N	Front Wheel Carriage Assembly
	E-39173-119N	Front Wheel
	E-70022-1	Front Axle
51	E-53201	Clamp
52	E-53238-27	Screw
53	E-70042-333N	Handle Release
54	E-70043	Spring
55	E-61110	Belt Style R Kevlar
56	E-53238-8	Screw
57	E-70041-288N	Furniture Guard
58	E-70199-119N	Linkage Arm
59	E-53238-27	Screw
60	E-70194CSV	Belt Tensioner
61	E-60160	Screw
62	E-71413-1	Platform Assembly
63	E-70573-119N	Elevator Cam
64	E-70615-333N	Elevator Knob
65	E-53238-4	Screw
66	E-71720	Cord Shield
67	E-70608-1SV	Air Duct Assembly
68	E-70055-3	Gasket
69	E-71384	Plug
70	E-70085	Motor Support Gasket
71	E-70609	Wiring Harness
72	E-70651	Flexible Tube
73	E-70652	Sound Foam
74	E-70843-2	Dirt Sensor Housing Assembly
75	E-70622-1	Dirt Tube Assembly
76	E-70547-119N	Wand & Crevice Tool Retainer
77	E-53238-27	Screw
78	E-70563-119N	Tool Caddy
79	E-38680-27	Cord
80	E-71331-2	Socket Assembly
81	E-61256-1	Motor
82	E-70084	Motor Bushing
83	E-70665	Motor Hub Seal
84	E-70621-288N	Grommet
85	SS-3270	Wire Nut
86	E-57687-1	Cable Clamp
87	E-71681	Pre-Filter Tube Assembly
88	E-71643	Pre-Filter
89	E-70611-119N	Filter Screen Handle
90	E-71548	Filter Screen & Handle Assembly
91	E-61498-1	Dust Cup Assembly
92	E-39186	Nesting Wand Assembly
93	E-61499-1	Hose Assembly
94	E-60990-2	Combination Brush
95	E-28251-119N	Crevice Tool
96	E-71031	Hardware Package