

This Owner's Manual is provided and hosted by [Appliance Factory Parts](http://www.ApplianceFactoryParts.com).

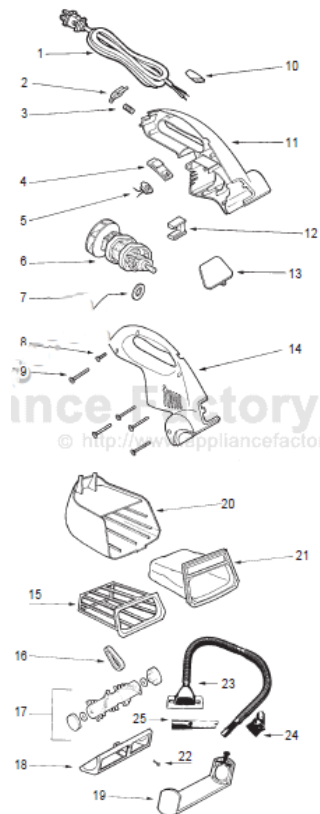

Eureka 55AT Owner's Manual

[Shop genuine replacement parts for Eureka 55AT](#)



[Find Your Eureka Vacuum Cleaner Parts - Select From 855 Models](#)

----- Manual continues below -----

EUREKA Original & Replacement

CORVETTE HAND VAC 53A, 55AT

KEY	PART NO.	DESCRIPTION
1	E-27080-1	Cord and Plug Ass'y
1	FA-3020	Cord and Plug Ass'y
2	E-26917-2	Latch Button 55AT
2	E-26917-1	Latch Button 53A
3	E-55794	Spring
4	NLA	Switch Button
5	E-56006	Switch
6	E-53875	Motor Ass'y
7	E-58251	Motor Mount 55AT
7	E-56973	Motor Mount 53A
8	E-53839-1	Screw, 5 Pk
9	NLA	Screw
10	E-37996-1	Strain Relief Sleeve
11	NLA	Housing Ass'y Set
12	E-26911	Wire Tube
13	E-37990-2	Belt Cover Ass'y
14	NLA	Belt Ass'y Set
15	E-14329-1	Filter Support
16	NLA	Belt, 2 Pk
16	E-38001	Belt
17	NLA	Brushroll Ass'y
18	E-14331-2	Sole Plate 55AT
18	E-14331-1	Sole Plate 53A
19	E-38000-2	Disturbulator Cover Ass'y 55AT
19	E-38000-1	Disturbulator Cover Ass'y 53A
20	E-14472-2	Dust Container & Graphics Ass'y 55'y
20	E-14472-1	Dust Container & Graphics Ass'y 53A
21	E-53820	Filter Ass'y
22	E-53842	Screw, 5 Pk
23	E-54554	Hose and Adapter
24	E-53455-5	Dusting Brush
25	E-54355-3	Crevice Tool

