

This Owner's Manual is provided and hosted by [Appliance Factory Parts](http://www.appliancefactoryparts.com).

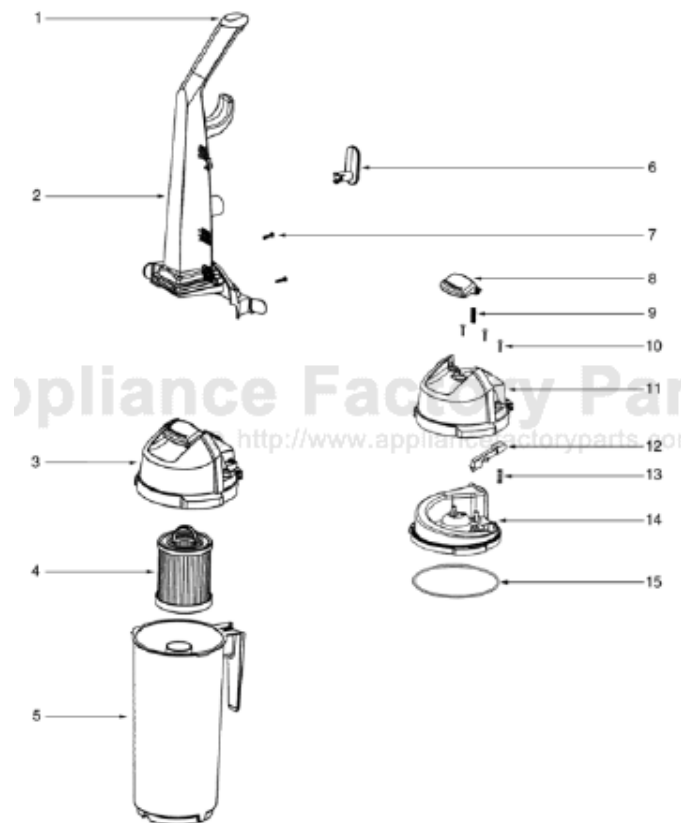

Eureka 5740A-1 Owner's Manual

[Shop genuine replacement parts for Eureka 5740A-1](#)



[Find Your Eureka Vacuum Cleaner Parts - Select From 853 Models](#)

----- Manual continues below -----

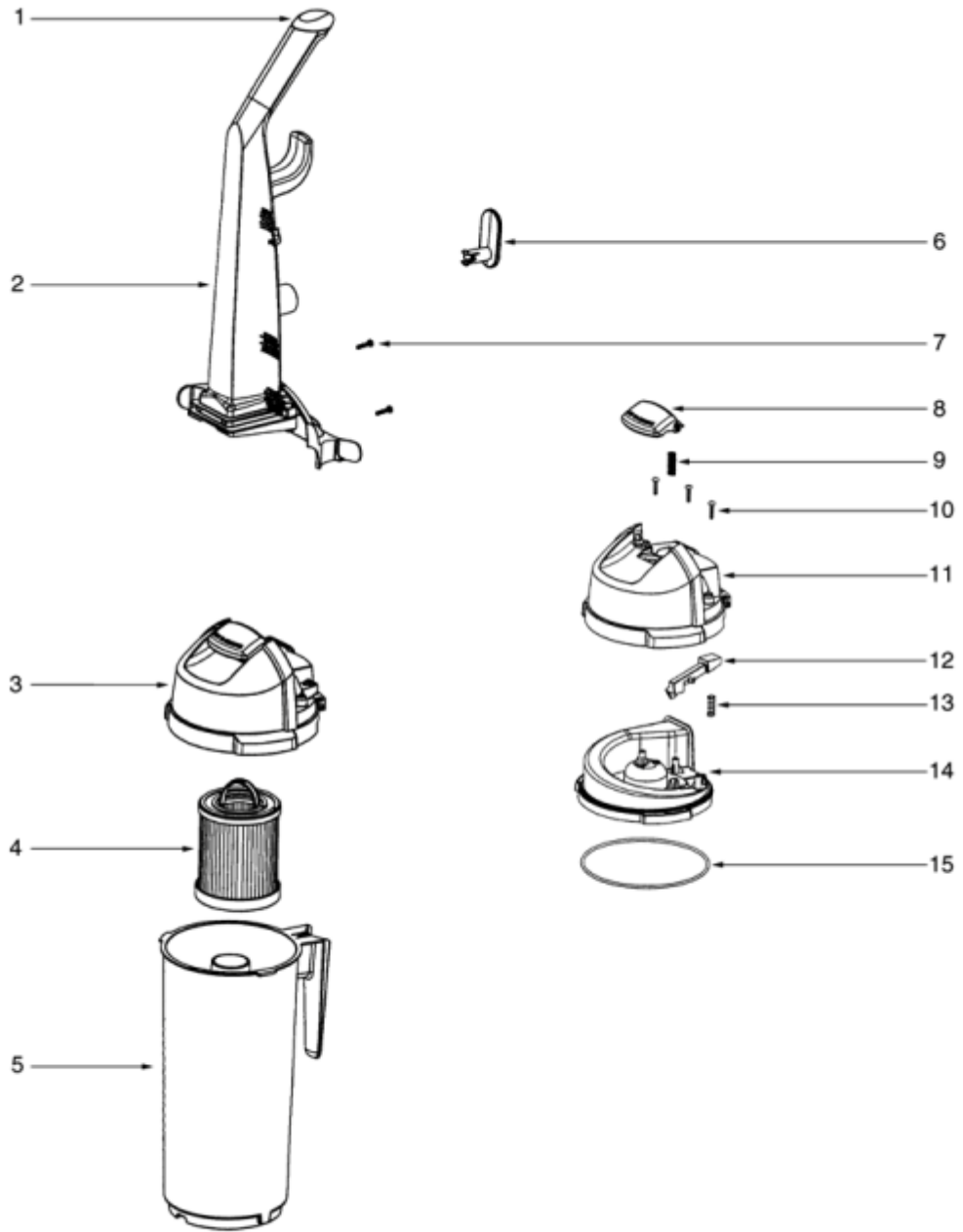

PARTS 3 - 5740A-1

Ref #	Part	Description	Comments	Qty
1	E-71235-119N	CAP - HANDLE		
2	E-71473	HANDLE ASSEMBLY		
3	E-71537-1	CYCLONE ASSEMBLY		
4	E-61825	DUST CUP FILTER (57/5800'S)		
5	E-61864-1	DUST CUP ASSY - PKGD		
6	E-70864A-119N	HOOK - CORD		
7	E-53238-44	SCREW PACKAGE		
8	E-71479-333N	LATCH - DUST CUP		
9	E-61866	SPRING PACKAGE		
10	E-53238-27	SCREW PACKAGE		
11	E-72004-1	CYCLONE ASSEMBLY		
12	E-71785-119N	CATCH - FILTER IN PLACE		
13	E-61867	SPRING PACKAGE		
14	E-71451-119N	CYCLONE		
15	E-71475	GASKET - CYCLONE		

PARTS 2 - 5740A-1

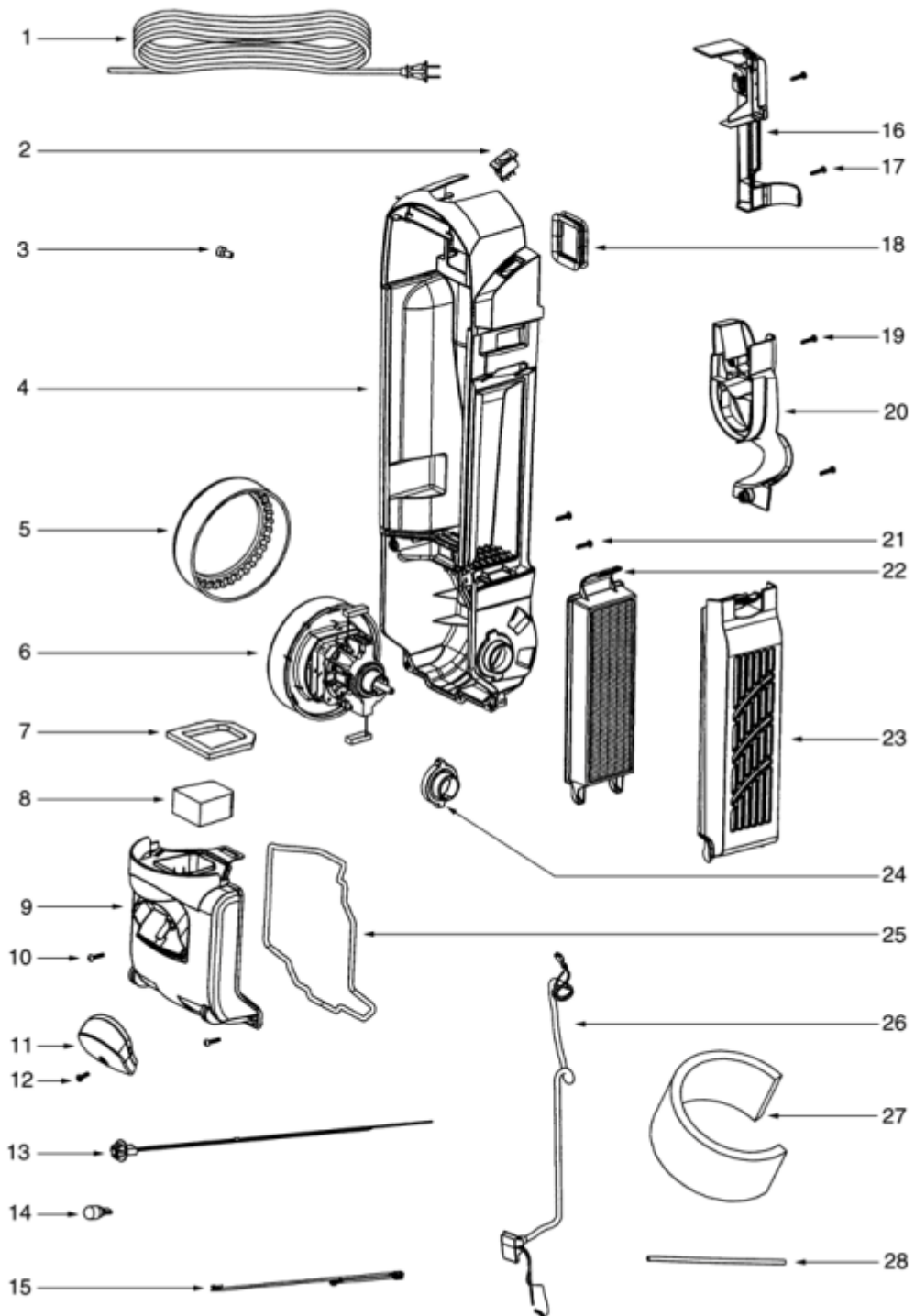

PARTS 2 - 5740A-1

Ref #	Part	Description	Comments	Qty
1	E-38680-29	SUPPLY CORD & TERMINAL AS		
2	E-39455-1	SWITCH - ROCKER		
3	E-60192-1	WIRE SPLICE 5		
4	E-72126B	REAR HOUSING ASSEMBLY		
5	E-71649	GASKET-MOTOR		
6	E-60261-11	MOTOR ASSY. (NLA)		
7	E-71483	GASKET - DIRT CUP LOWER		
8	E-71480	FILTER - PRE-MOTOR		
9	E-61863-1	MOTOR COVER ASSY - PACKAG		
11	E-71460-313N	LENS - HEADLAMP		
12	E-53238-44	SCREW PACKAGE		
13	E-70701-2	SOCKET & TERMINAL ASSY		
14	E-57940-2	HEADLIGHT		
15	E-39252-1	THERMOSTAT & TERMINAL ASS		
16	E-72127	SWITCH COVER ASSEMBLY		
18	E-71482	GASKET - INTAKE		
20	E-71455-119N	TOOL PACK - LOWER		
21	E-53238-27	SCREW PACKAGE		
22	E-61830	HEPA FILTER PKG - STYLE H		
23	E-72006-1	FILTER COVER & GRAPHICS A		
24	E-70084	BUSHING - MOTOR SUPPORT		
25	E-71484	GASKET - MOTOR COVER		
26	E-71465	CORD - JUMPER		
27	E-72224-1	FOAM - SOUND		
28	E-70651-1	TUBE - FLEXIBLE		

PARTS 1 - 5740A-1

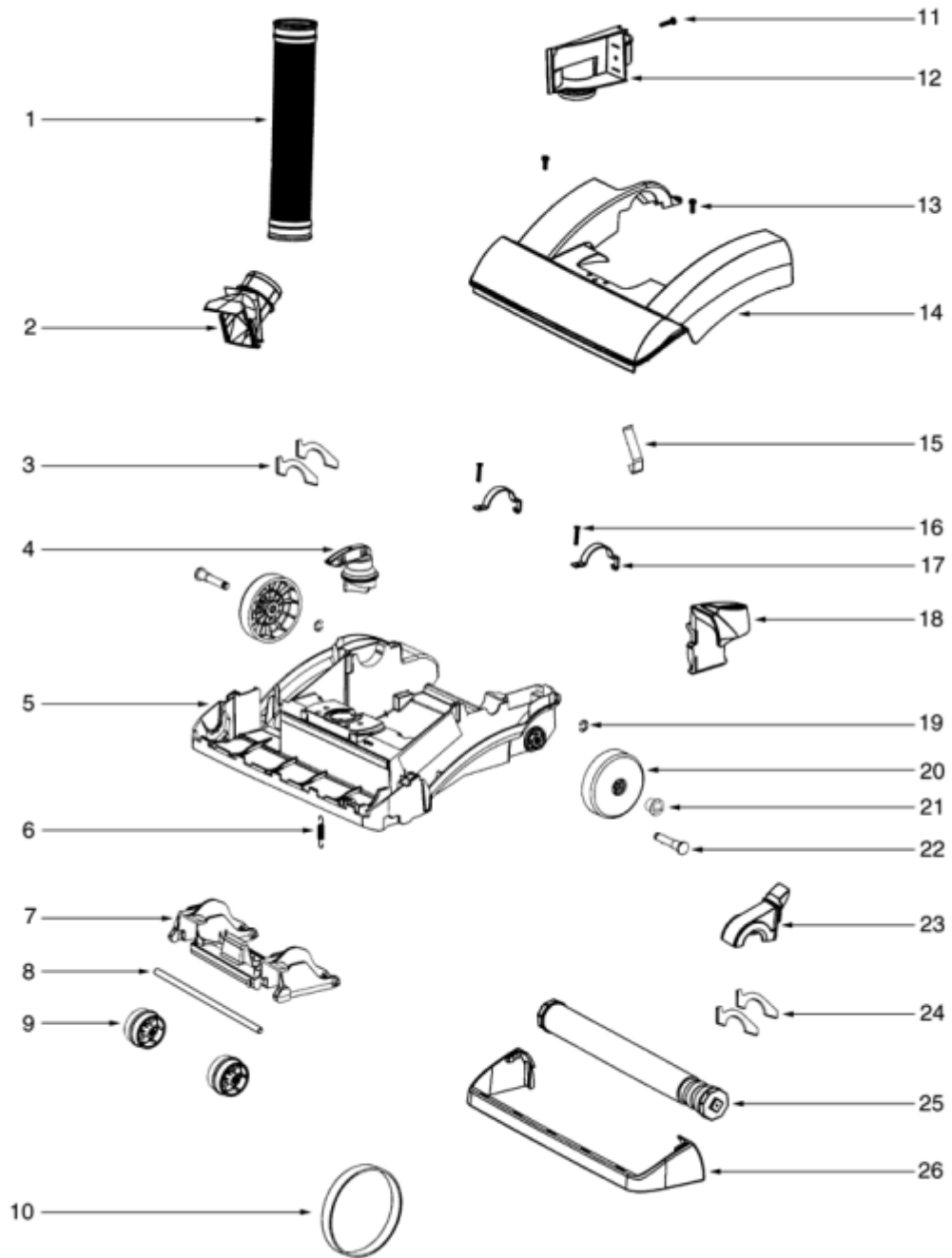

PARTS 1 - 5740A-1

Ref #	Part	Description	Comments	Qty
1	E-71466	BASE HOSE ASSY.		
2	E-71447-119N	BASE HOSE ASSY		
3	E-71673A	FELT - BASE		
4	E-71448-333N	KNOB-HEIGHT ADJUSTMENT		
5	E-61860-1	BASE ASSEMBLY - PACKAGED		
6	E-54943	SPRING PACKAGE		
7	E-71446-119N	CARRIAGE WHEEL		
8	E-71478	AXLE - FRONT		
9	E-39173A-119N	WHEEL - FRONT		
10	E-61120A	BELT (LONG LIFE)-U		
12	E-71726-119N	BASE HOSE ASSY		
13	E-53238-44	SCREW PACKAGE		
14	E-61862-3	HOOD ASSEMBLY - PACKAGED		
15	E-71574	SPRING - HANDLE RELEASE		
16	E-53238-27	SCREW PACKAGE		
17	E-71487	CLAMP - MOTOR		
18	E-71457-333N	RELEASE - HANDLE		
19	E-54432-1	PKG-RTNG RING10		
20	E-72117-119N	WHEEL - REAR		
21	E-70004			
22	E-38590A	AXLE - REAR		
23	E-71741	BELT CAP ASSEMBLY		
24	E-71672A	FELT-BELT CAP		
25	E-61861-2	BRUSH ROLL ASSY		
26	E-71456-355N	GUARD - FURNITURE		

ACCESSORIES - 5740A-1

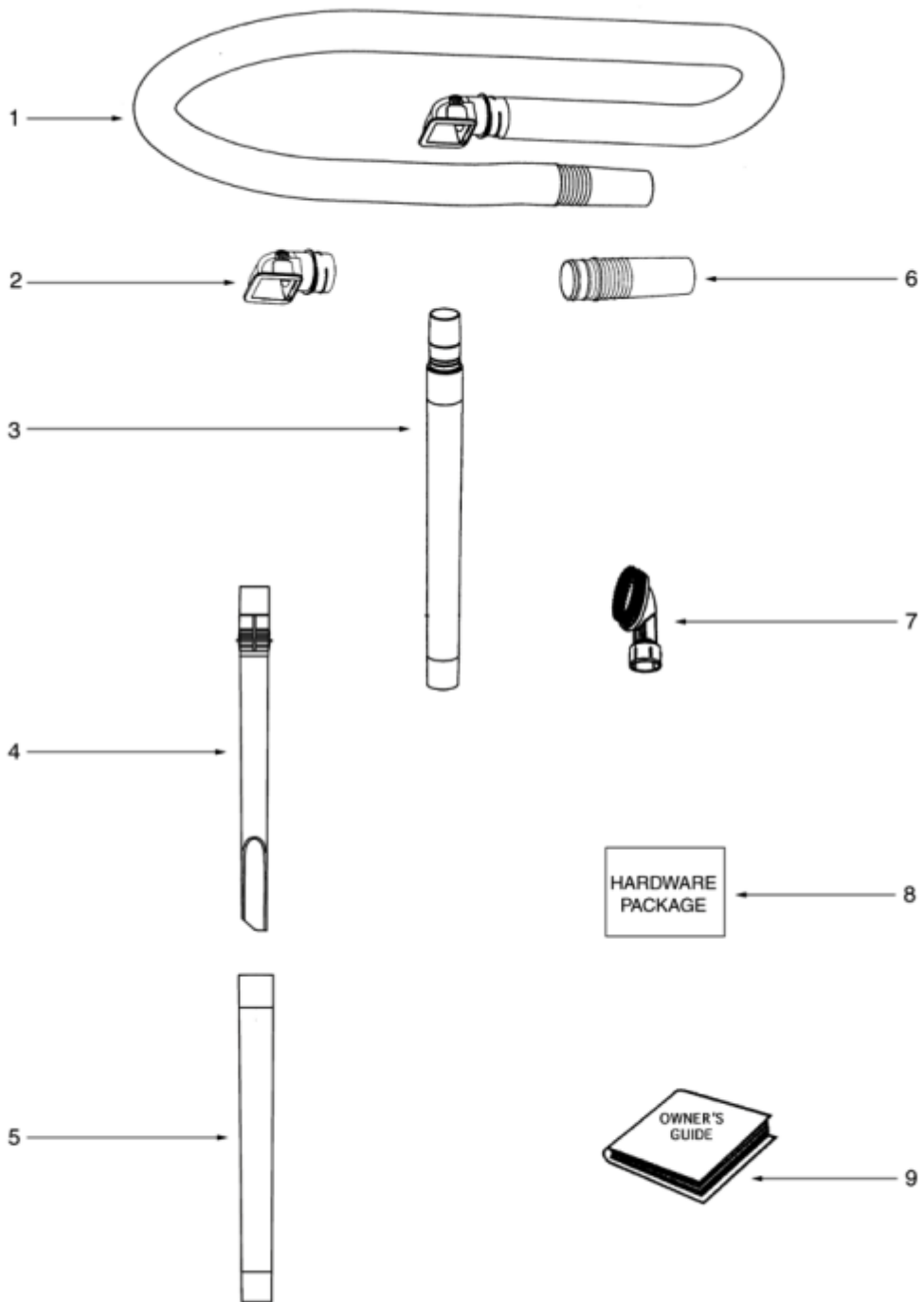

ACCESSORIES - 5740A-1

1	E61865-1	HOSE ASSEMBLY - CARTONED		
2	E-71725-313N	ADAPTER - HOSE		
3	E-71492A	NESTING WAND ASSEMBLY		
4	E-71956A-355N	WAND - CREVICE		
5	E-71973-119N	WAND - OUTER		
6	E-70559A-119N	COUPLING - HOSE		
7	E-60990-2	COMBINATION BRSH BRSTLD-C		
8	E-72323	HARDWARE PACKAGE		
9	E-71496	OWNER'S GUIDE		