

This Owner's Manual is provided and hosted by [Appliance Factory Parts](http://www.appliancefactoryparts.com).

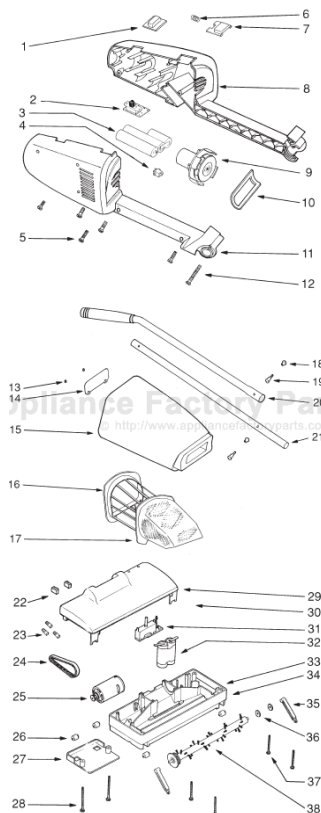

Eureka 94A Owner's Manual

[Shop genuine replacement parts for Eureka 94A](#)



[Find Your Eureka Vacuum Cleaner Parts - Select From 855 Models](#)

----- Manual continues below part list -----

Available Replacement Parts for Eureka 94A

[E-55692](#)

RETAINER RING, DIRT FLAP FOR EUREKA

Original & Replacement

EUREKA

BRUSH-UP/BOSS LITE

Model 93A, 94A

KEY	PART NO.	DESCRIPTION
1	E-37631-1	Switch Button
2	NLA	Circuit Board & Switch Ass'y
3	E-37460	Battery Set
4	E-37663	Jack
5	E-55712	Screw
6	E-55794	Spring
7	E-37449-2	Latch 94A
7	E-37449-5	Latch 93A
8	E-01672-1	Housing & Graphics (LH) 94A
8	E-14486-4	Housing & Graphics (LH) 93A
9	E-37461	Motor Ass'y
10	E-37457	Seal
11	E-01671-1	Housing & Graphics (RH) 94A
11	E-01671A-4	Housing & Graphics (RH) 93A
12	E-55712-1	Screw
13	E-55692	Push-on Ring
14	E-37464	Flap
15	NLA	Dust Container
16	E-13920-1	Filter Support
17	E-37466-1	Filter Ass'y
18	E-56003	Handle Retainer Nut
19	E-56004	Handle Retainer Screw
20	E-37665-1	Handle Ass'y - Upper
21	E-37671-1	Handle Tube - Lower
22	E-56328	Motor Pad
23	E-52314-1	Wire Nut
23	SS-3270	Wire Nut
24	E-56334	Drive Belt
25	E-37664	Motor & Pulley Ass'y 94A
25	E-38546	Motor & Pulley Ass'y 93A
26	E-53252	Wheel & Axle
27	E-14050-1	Base Cover Plate 94A
27	E-14050-4	Base Cover Plate 93A
28	E-55712-3	Screw
29	E-01674-1	Nozzle Cover & Graphics Ass'y 94A
29	E-14487-3	Nozzle Cover & Graphics Ass'y 93A
30	E-37476	Upper Gasket
31	E-53288	Circuit Board & Breaker Ass'y
32	NLA	Battery Set
33	E-01673-1	Nozzle Base 94A
33	E-01673-4	Nozzle Base 93A
34	E-37477	Lower Gasket
35	E-37658	Bearing Arm
36	E-56333	Sealing Washer
37	E-55712-4	Screw
38	E-26654	Disturbulator Ass'y
	E-56396	Hardware Package (Not Illustrated)
	E-56003	Hand. Ret. Nut
	E-56004	Hand. Ret. Screw
	E-56019	Screw
	E-56020	Plastic Anchor
	E-26655-1	Transformer (Not Illustrated)
	E-14089-1	Charging Stand (Not Illustrated)

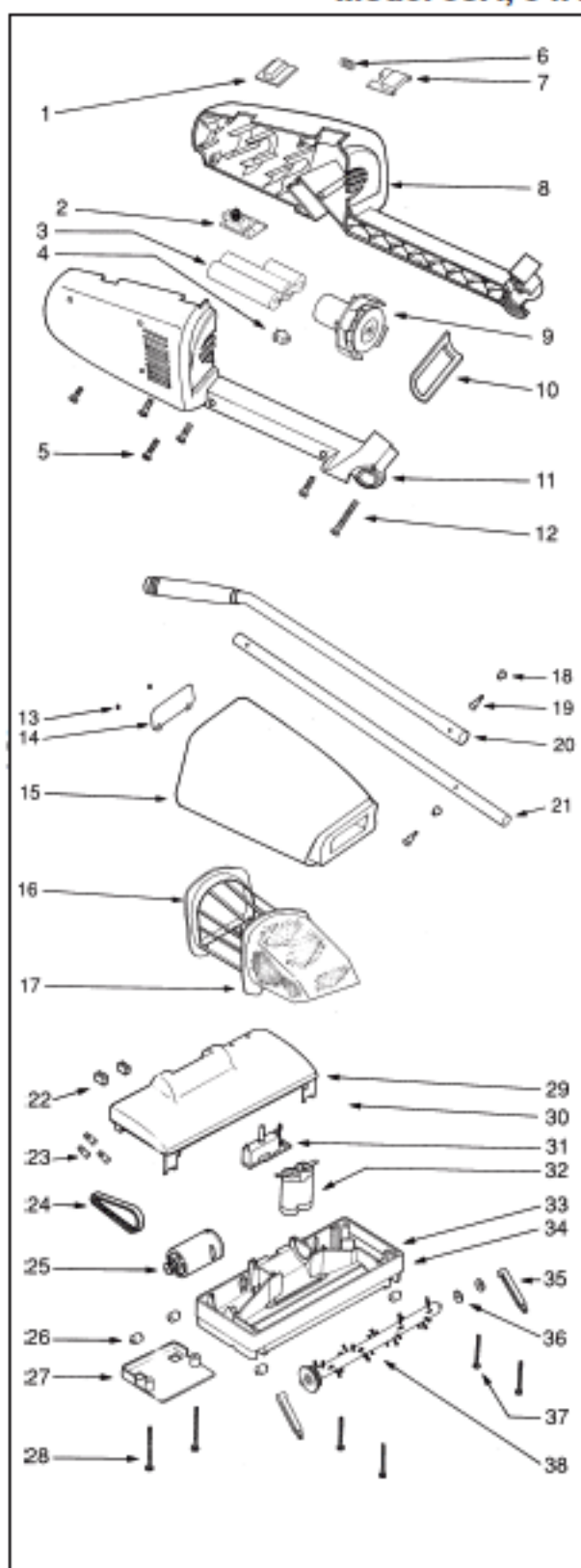

NLA= No Longer Available