

This Owner's Manual is provided and hosted by [Appliance Factory Parts](http://ApplianceFactoryParts.com).

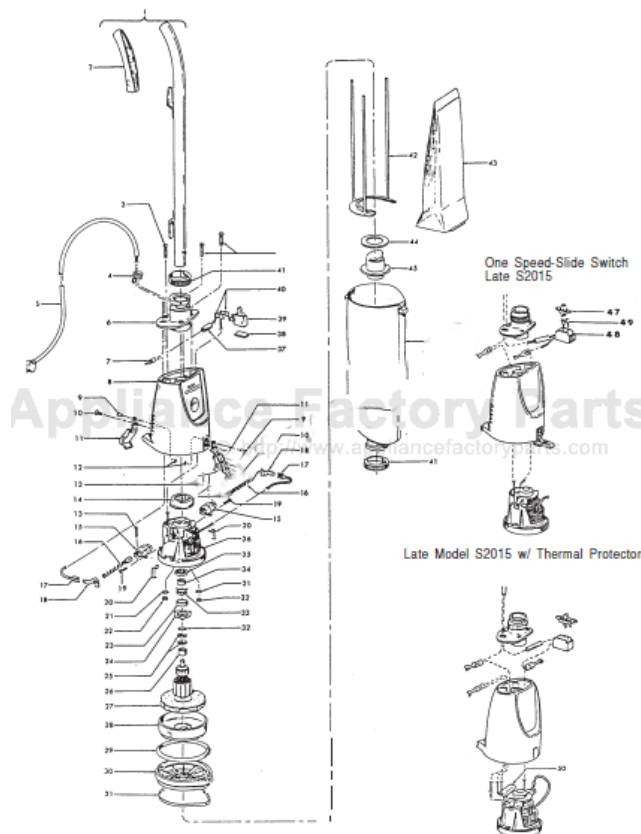

HOOVER 2910 Owner's Manual

[Shop genuine replacement parts for HOOVER 2910](#)



[Find Your HOOVER Vacuum Cleaner Parts - Select From 1456 Models](#)

----- Manual continues below -----

HOOVER Original

HANDIVAC

Models 2900, 2901, 2904, 2910, 2911, 2941, 2950, 2960,
2980, S2003, S2005, S2007, S2011, S2013, S2015, S2085

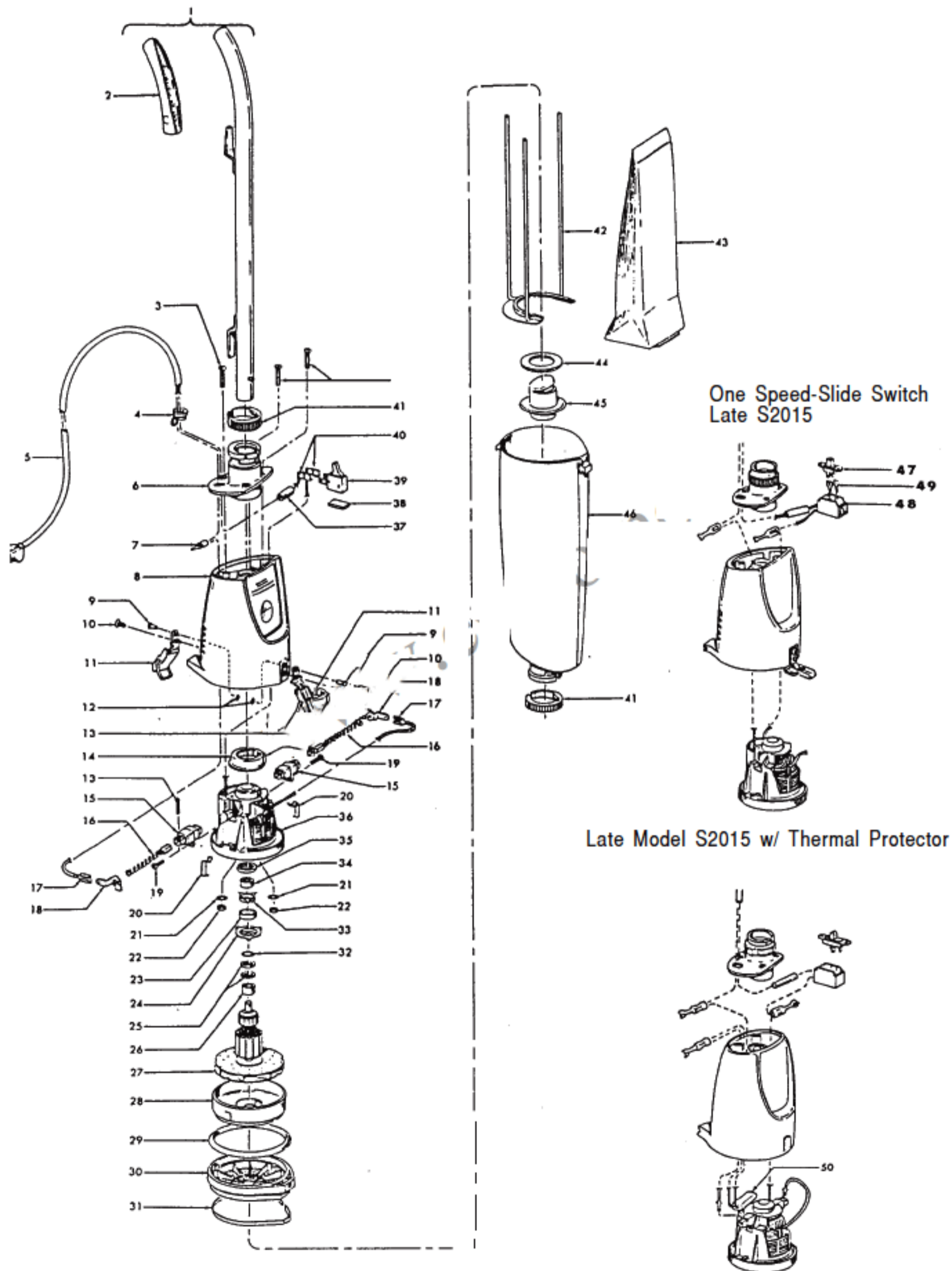

Original **HOOVER**

HANDIVAC

Models 2900, 2901, 2904, 2910, 2911, 2941, 2950, 2960, 2980, S2003, S2005, S2007, S2011, S2013, S2015, S2085

KEY	PART NO.	DESCRIPTION	KEY	PART NO.	DESCRIPTION
1	H-15665 LL +	Handle - 2900, 2901, 2904, 2910, 2911, 2950	27	H-44731003	Armature & Fan Ass'y
	H-161412 LL +	Handle - 2941	28	H-15293	Fan Hsg. & Brg. Ass'y (Used on the following Models until 6/72 - 2900, 2901, 2904, 2910, 2911, 2941, 2950, 2960, 2980)
	H-161412 DM	Handle - 2960		H-163441	Fan Housing & Bearing Ass'y
	H-166791 EK +	Handle - 2980	29	H-15315	Motor Gasket
	H-48646008	Handle - S2003	30	H-15326 BZ	Bulkhead (Req. Secondary Filter 15997)
	H-48646044	Handle - S2005		H-19586 AG	Bulkhead - 2904, 2910 (Req. Secondary Filter 15997)
	H-48645023	Handle - S2007		H-166116 AG	Bulkhead - S2003, S2005, S2007, S2011, S2013, S2015, S2085
	H-48646012 +	Handle - S2011		H-15330	Bag Housing Gasket
	H-48643084	Handle - S2015, S2013, S2085	31	H-16816 *	Washer
2	H-12230 JM	Handle Grip - S2003, S2005, S2011, S2013	32	H-15851 *	Bearing Retainer
	H-12230 DS +	Handle Grip	34	H-24117209	Bearing
3	H-15738 EF	Screw (3)	35	H-15295 *	Felt Washer
4	H-12226	Strain Relief Bushing	36	H-15272 +	Mtr. Casing & Field Ass'y (Used on the following Models until 6/72 - 2900, 2901, 2904, 2910, 2911, 2941, 2950, 2960, 2980) - Toggle Switch
	H-163768	Strain Relief - S2011, S2013, S2015, S2085		H-45312021	Mtr. Casing & Field Ass'y - Toggle Switch
5	H-46383241	Attach. Cord		H-45312055	Mtr. Casing & Field Ass'y Model S2015's equipped w/Slide Switch
6	H-37226118	Closure Plate - Common - One Speed - Toggle Switch		H-45312038 *	Motor Case & Field Ass'y - S2085
	H-42227098	Closure Plate/Latch Ring - One Speed - Model S2015's equipped w/Slide Switch	37	H-31722007 *	Insulator
	H-42227090	Closure Plate/Latch Ring - S2085	38	H-15317 *	Switch Pad (Toggle Switch)
7	H-48969 *	Wire Nut	39	H-12971 *	Switch (Toggle)
8	H-42222057	Motor Housing - 2900, 2911, 2941, 2960, 2980, S2003, S2005	40	H-161350	Terminal (2) - Toggle Switch
	H-161252 JM	Motor Housing - 2901, 2904, 2910, S2007	41	H-36153008	Latch Ring
	H-162909 AR +	Motor Housing - 2950	42	H-15650	Bag Support - Long - 2900, 2941, 2950, 2960, 2980, S2003, S2005, S2011, S2013
	H-42221011	Motor Housing - CD - S2011		H-15327	Bag Support - Short - 2901, 2904, 2910, 2911, S2007, S2015, S2085
	H-42221021	Motor Housing - DS - S2013	43	H-4010007 F	Throw Away Bag - 3 Pack - Long
	H-42221035	Motor Housing w/Thermal Protector S2015	44	H-4010008 G	Throw Away Bag - 3 Pack - Short
	H-42222149	Motor Housing w/Thermal Protector S	45	H-17295	Bag Sealing Collar
9	H-16195 *	Rivet (2)	46	H-15311 JM	Bag Gasket
10	H-12954 *	Screw (2)		H-18351 JM	Bag Housing - Short - 2901, 2904, 2910, 2911, S2015, S2085
11	H-15331 AY	Latch (2)		H-164538 DR	Bag Housing - Short - S2007
12	H-161549	Washer (2)		H-15652 LL +	Bag Housing - Long - 2900, 2941, 2960
	H-21312758	Washer (2) - S2085		H-163163 DS +	Bag Housing - Long - S2013
13	H-49435 *	Cotter Pin (2) N.A. on Model S2015's equipped w/Slide Switch Model S2085		H-163753 LL +	Bag Housing - Long - 2950
&	H-15316	Motor Mount		H-166787 EK +	Bag Housing - Long - 2980
14	H-15275 AG	Brush Holder (2)		H-42223006	Bag Housing - Long - S2003
15	H-161749 AG	Brush Holder (2) Model S2015's equipped w/Slide Switch; S2085		H-42223007	Bag Housing - Long - S2011
16	H-17353	Motor Brush & Spring (2)		H-42223011 +	Bag Housing - Long - S2005
	H-47311004	Mtr. Brush & Spring (2) Model S2015's equipped w/Slide Switch; S2085	47	H-28177005	Switch (Slide) - Late Model S2015's
17	H-12227	Terminal (2)		H-47517014	Switch w/Diode - S2085
	H-161876	Terminal (2) Model S2015's equipped w/Slide Switch; S2085	48	H-37922002	Terminal Shield - Late Model S2015's, S2085
18	H-15894 +*	Motor Brush Retainer (2) N.A. on Model S2015's equipped w/Slide Switch & Model S2085	49	H-27666702 *	Terminal - Late Model S2015's, S2085
19	H-162911	Screw (2)	50	H-28382028	Therma Protector - Late Model S2015's, S2085
20	H-163416	Clip (2)	ITEMS NOT ILLUSTRATED		
	H-15744	Clip (2) (Used on the following Models until 6/72 - 2900, 2901, 2904, 2910, 2911, 2941, 2950, 2960, 2980)		H-43576019	Motor Ass'y Comp. - Single Speed - Toggle Switch
21	H-21312759 *	Washer (2)		H-43576051	Motor Ass'y Comp. - Single Speed - Model S2015's equipped w/Slide Switch
22	H-162910 *	Nut (2)		H-43576021	Motor Ass'y Comp. - Two Speed - S2085
23	H-12012 *	Absorbent Washer			
24	H-15850 *	Bearing Retainer Support			
25	H-15278 *	Fiber Washer (2)			
26	H-49344 *	Insulator			
	H-31148006	Spacer - S2085			

HOOVER Original

HANDIVAC

Rug & Floor Nozzle

Models 2910, S2005, S2007, S1021, S1021-030, S2013, S2015, S2029, S2031, S2033, S2047, S2053, S2053-032, S2053-042, S2053-942, S2055, S2057, S2085

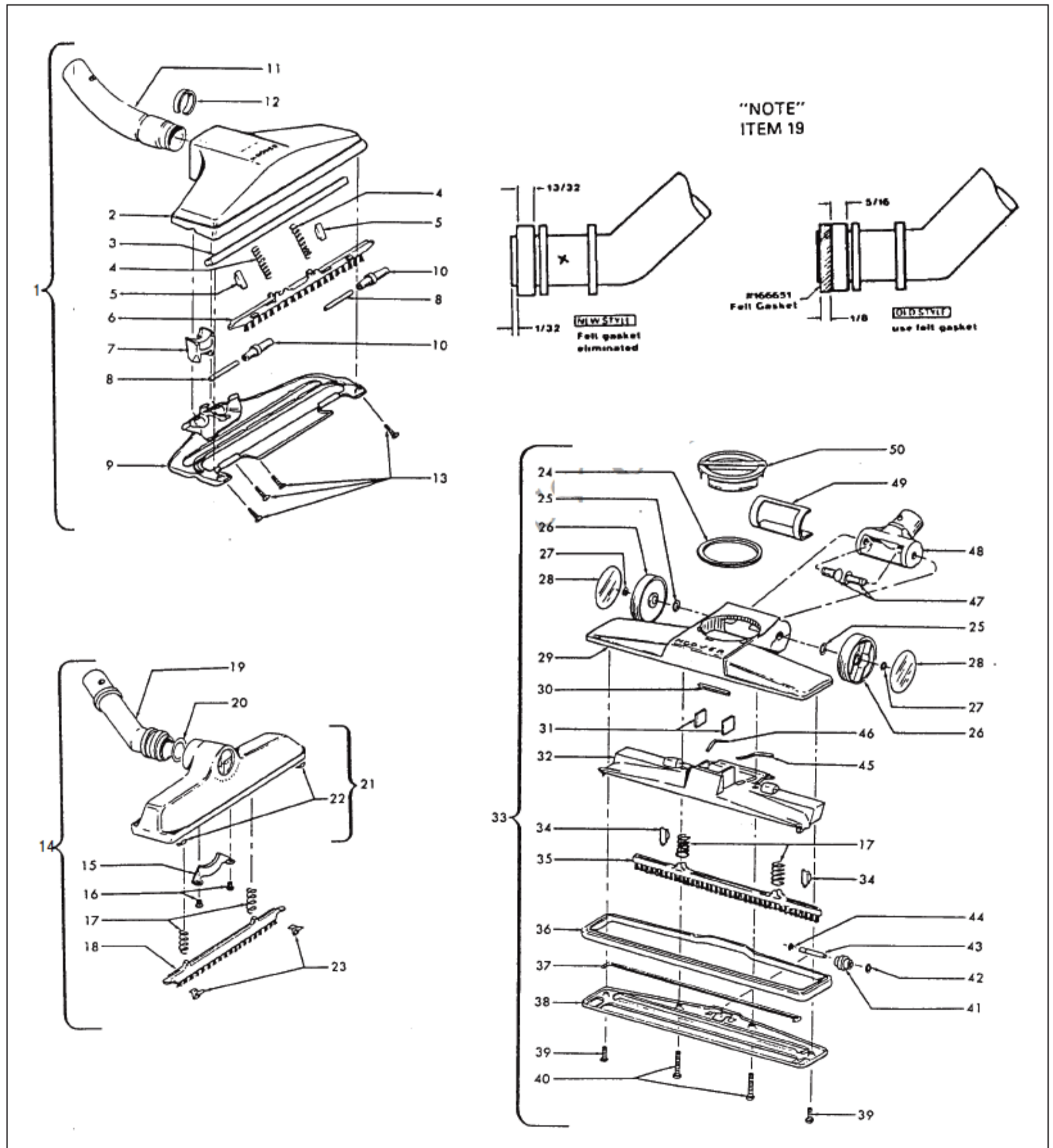

Original

HOOVER

HANDIVAC

Rug & Floor Nozzle

Models 2910, S2005, S2007, S1021, S1021-030, S2013, S2015, S2029, S2031, S2033, S2047, S2053, S2053-032, S2053-042, S2053-942, S2055, S2057, S2085

KEY	PART NO.	DESCRIPTION	KEY	PART NO.	DESCRIPTION
1	H-43414101	Rug & Floor Nozzle Comp. - AAP - S2031	28	H-169242	Wheel Cover (2) - S2029, S2053, S2053-042, S2053-942, S2055
2	H-38615156	Nozzle - JM - S2031	29	H-169260 EU	Rug & Floor Nozzle - S2029
3	H-16214	Gasket - S2031		H-169260 JZ	Rug & Floor Nozzle - S2053
4	H-15963 FW	Spring (2) - S2031		H-169260 FN	Rug & Floor Nozzle - S2055
5	H-13261 AY *	Rug Nozzle Rib Shoe (2) - S2031		H-38615164	Rug & Floor Nozzle - S2053-042, S2053-942
6	H-16184	Brush Back Ass'y - S2031	30	H-34112001	Seal - Foam - S2029, S2053, S2053-042, S2053-942, S2055
7	H-161413 *	Nozzle Tube Retainer - S2031	31	H-34223002	Seal - Felt (2) - S2029, S2053, S2053-042, S2053-942, S2055
8	H-13272 +	Roller Shaft (2) - S2031	32	H-169250 AG	Brush Housing - S2029, S2053, S2053-042, S2053-942, S2055
9	H-42246002	Bottom Plate-Edge Cleaning - S2031	33	H-43414101	Rug & Floor Nozzle Comp.- AAP - S2029, S2053
10	H-13157 AG	Roller (2) - S2031		H-48476053 +	Rug & Floor Nozzle Comp. - JZ
11	H-43463012	Nozzle Connector Tube - JM - S2031		H-48476054	Rug & Floor Nozzle Comp. - FN - S2055
12	H-13267 +*	Gasket - S2031		H-48476091	Rug & Floor Nozzle Comp. - MX - S2053-042, S2053-942
13	H-12955	Screw - Self Tapping (4) - S2031	34	H-169253 AY	Rib Shoe (2) - S2029, S2053, S2053-042, S2053-942, S2055
14	H-43414121	Rug & Floor Nozzle Comp. - JM - 2910, S2005, S2007, S1021, S1021-030, S2013, S2015, S2033, S2047, S2053-032, S2057, S2085	35	H-169256	Brush Back Comp. - S2029, S2053, S2053-042, S2053-942, S2055
15	H-166650 AY	Connector Tube Clamp - 2910, S2005, S2007, S1021, S1021-030, S2013, S2015, S2033, S2047, S2053-032, S2057, S2085	36	H-169247 JM	Furniture Guard - Litter Picker
16	H-166648 AW *	Screw - Self Tapping (2) - 2910, S2005, S2007, S1021, S1021-030, S2013, S2015, S2033, S2047, S2053-032, S2057, S2085		H-169247 AG	Furniture Guard - Litter Picker - S2053-042, S2053-942
17	H-166649 FW	Spring (2) - 2019, S2005, S2007, S1021, S1021-030, S2013, S2015, S2029, S2033, S2047, S2053-032, S2057, S2085	37	H-169251	Gasket - S2029, S2053, S2053-042, S2053-942, S2055
18	H-166656	Brush Block - 2910, S2005, S2007, S1021, S1021-030, S2013, S2015, S2033, S2047, S2053-032, S2057, S2085	38	H-169538	Bottom Plate Ass'y - S2029, S2053, S2053-042, S2053-942, S2055
19	H-166652 JM	Nozzle Tube - 2910, S2005, S2007, S1021, S1021-030, S2013, S2015, S2033, S2047, S2057 (See Note)	39	H-21481464	Screw (2) - S2029, S2053, S2053-042, S2053-942, S2055
20	H-166651	Gasket - Felt - 2910, S2005, S2007, S1021, S1021-030, S2013, S2015, S2033, S2047, S2057	40	H-21481465	Screw (2) - S2029, S2053, S2053-042, S2053-942, S2055
21	H-43482057	Nozzle, Lock, Pad Ass'y - 2910, S2005, S2007, S1021, S1021-030, S2013, S2015, S2033, S2047, S2053-032, S2057, S2085	41	H-169243 AG	Roller - S2029, S2053, S2053-042, S2053-942, S2055
22	H-34121001	Pad - Felt (2) - 2910, S2005, S2007, S1021, S1021-030, S2013, S2015, S2033, S2047, S2053-032, S2057, S2085	42	H-21312758 *	Washer - S2029, S2053, S2053-042, S2053-942, S2055
23	H-166646	Brush Retainer Clips (2) - 2910, S2005, S2007, S1021, S1021-030, S2013, S2015, S2033, S2053-032, S2047, S2085	43	H-169244 AW	Roller Shaft - S2029, S2053, S2053-042, S2053-942, S2055
24	H-34113001 +	Seal - Foam - S2029, S2053, S2055	44	H-24735081 *	Lock Ring - S2029, S2053, S2053-042, S2053-942, S2055
25	H-169241 AW *	Washer (2) - S2029, S2053, S2053-042, S2053-942, S2055	45	H-34513001	Seal - Foam L.H. - S2029, S2053, S2053-042, S2053-942, S2055
26	H-169239 JR	Wheel (2) - S2029	46	H-34513002	Seal - Foam R.H. - S2029, S2053, S2053-042, S2053-942, S2055
27	H-13730	Wheel - S2053, S2053-042, S2053-942, S2055	47	H-169240 AY	Wheel Shaft (2) - S2029, S2053, S2053-042, S2053-942, S2055
		Lock Ring (2) - S2029, S2053, S2053-042, S2053-942, S2055	48	H-169249 JM	Connecting Tube Ass'y - S2029, S2053-042, S2053-942, S2055
				H-43486002	Connecting Tube Ass'y - S2053
			49	H-34122006	Seal - S2029, S2053, S2053-042, S2053-942, S2055
			50	H-43271039	Suction Control Knob - JM - S2029, S2053
				H-43271042 +	Suction Control Knob - JX - S2055
				H-169254 MX	Suction Control Knob - S2053-042, S2053-942