

This Owner's Manual is provided and hosted by [Appliance Factory Parts](http://ApplianceFactoryParts.com).

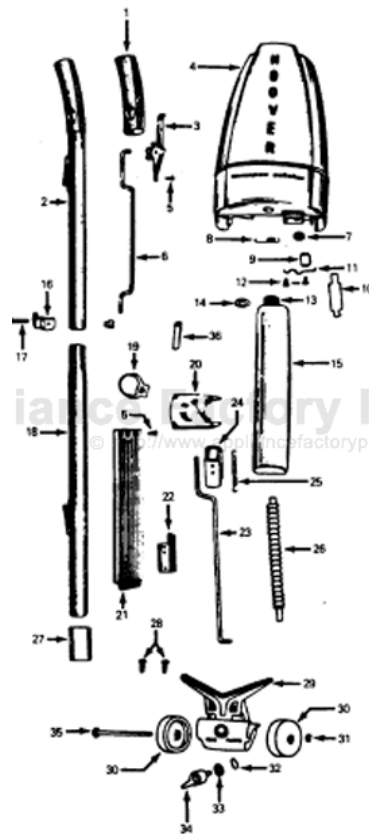

HOOVER 5137 Owner's Manual

[Shop genuine replacement parts for HOOVER 5137](#)



[Find Your HOOVER Vacuum Cleaner Parts - Select From 1456 Models](#)

----- Manual continues below part list -----

Available Replacement Parts for HOOVER 5137

12738	THUMB SCREW ASSEMBLY
KO-2410	Felt Buffing Pads, Pair.

Handle & Tank

Models 5020, 5130, 5131, 5137, 5240, 5350, 5450, 5460, 5466, 5468

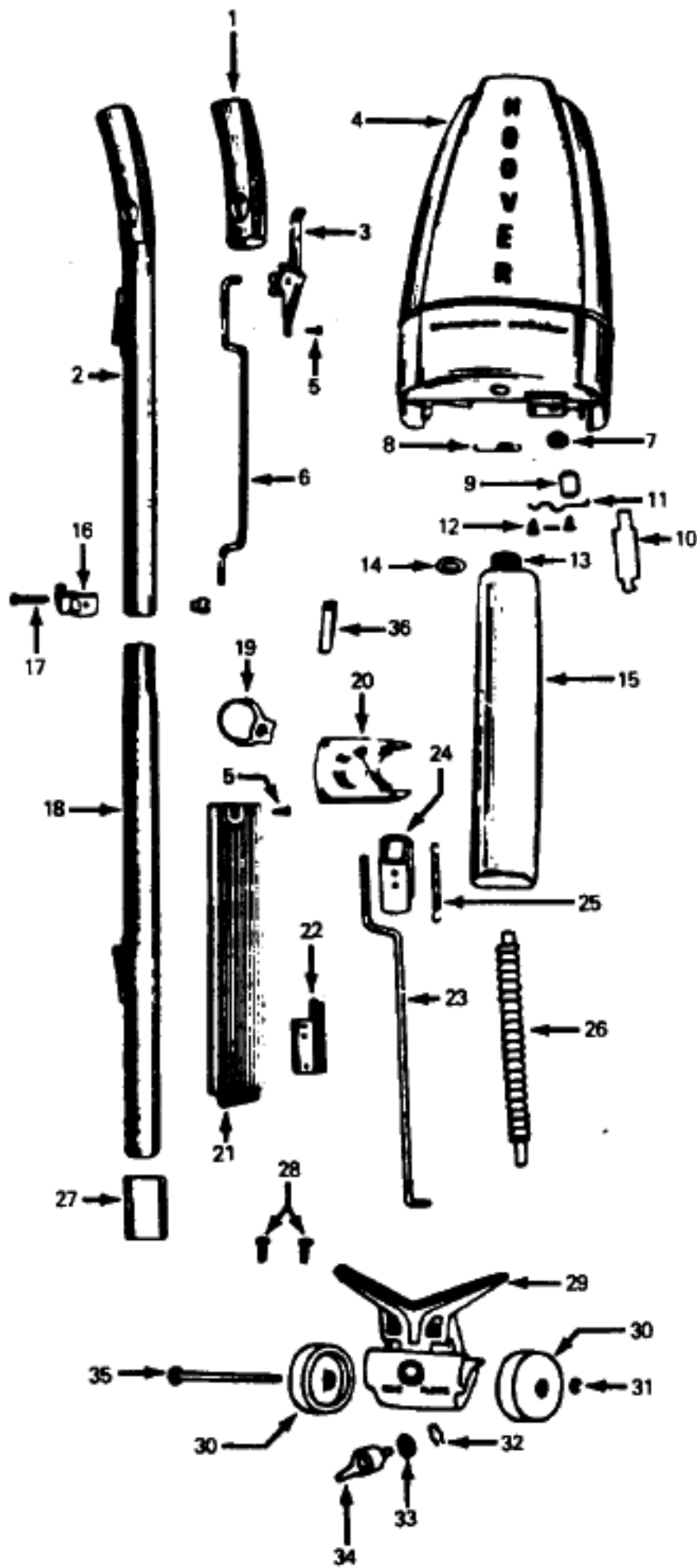

Ref. No.	Part No.	Description
1	12230JM	+ Handle Grip
	35636CC	+ Upper Handle - 5460, 5466, 5468
	49133A	+ Upper Handle - 5240
	35006A	+ Upper Handle - 5020, 5450
	49137A	+ Handle Assem. - Upper 5130, 5131, 5137, 5350
3	35433JM	+ Control Housing - 5460, 5466, 5468
4	35460AG	+ Detergent Tank - 5460, 5466
	35460BB	+ Detergent Tank - 5468
	35460X	+ Detergent Tank - All Models
5	21465314	* Screw
6	35405	+ Upper Valve Rod
7	48831	+* Seal
8	49220	+ Spring
9	35215T	+ Tank Valve
10	49126	+ Tank Valve Depressor
11	35379	+ Valve Closure Support
12	19254	+* Screw
13	49507	+ Wax Bottle Cap - All Models
14	49506	+* Washer
15	49187	+ Wax Bottle Assem.
16	35665A	+ Cord Support Clip - 5350
	12910	+ Cord Clamp - 5130, 5131, 5137
17	48294AW	+ Handle Bolt & Nut
18	35434R	+ Handle Assem. - Lower Half - 5240, 5460, 5466
	35434CC	+ Handle Assem. - Lower Half - 5468
	35007JM	+ Lower Handle - 5020, 5130, 5131, 5137, 5350, 5450
19	49219	+ Bottle Latch
20	11902X	+ Detergent Tank Cap
	11902BB	+ Detergent Tank Cap - 5468
21	35456	+ Trim Plate
22	35454DM	+ Cap Retainer
23	612866	+ Lower Valve Rod
24	12465	+ Handle Plug
25	12984AY	+ Spring
26	17473	+ Distributor Hose
27	35430	+ Handle Insulator
28	12956	* Screw
29	18853DN	+ Wheel Carriage & Distr. - All Models
	23348HH	+ Wheel Bracket - Only 5240
30	32175003	+ Caster Wheel
31	13306	* Ring
32	12979	* Ring
33	18249	+* Washer
34	17234	+ Valve Body
35	35662AY	+ Wheel Shaft - 5460, 5466, 5468
	49114	+ Wheel Shaft - 5240
36	14503	+ Insulating Tube - 5460, 5466, 5468

ITEMS NOT ILLUSTRATED

48750	+* Pin - 5460, 5466, 5468
35381	+ Distributor - 5240
35005AB	+ Cord Support - 5020, 5240, 5450
35004	+ Cord Support - 5020, 5240, 5450

Motor & Housing

Models 5130, 5131, 5137, 5350, 5460,
5466, 5468

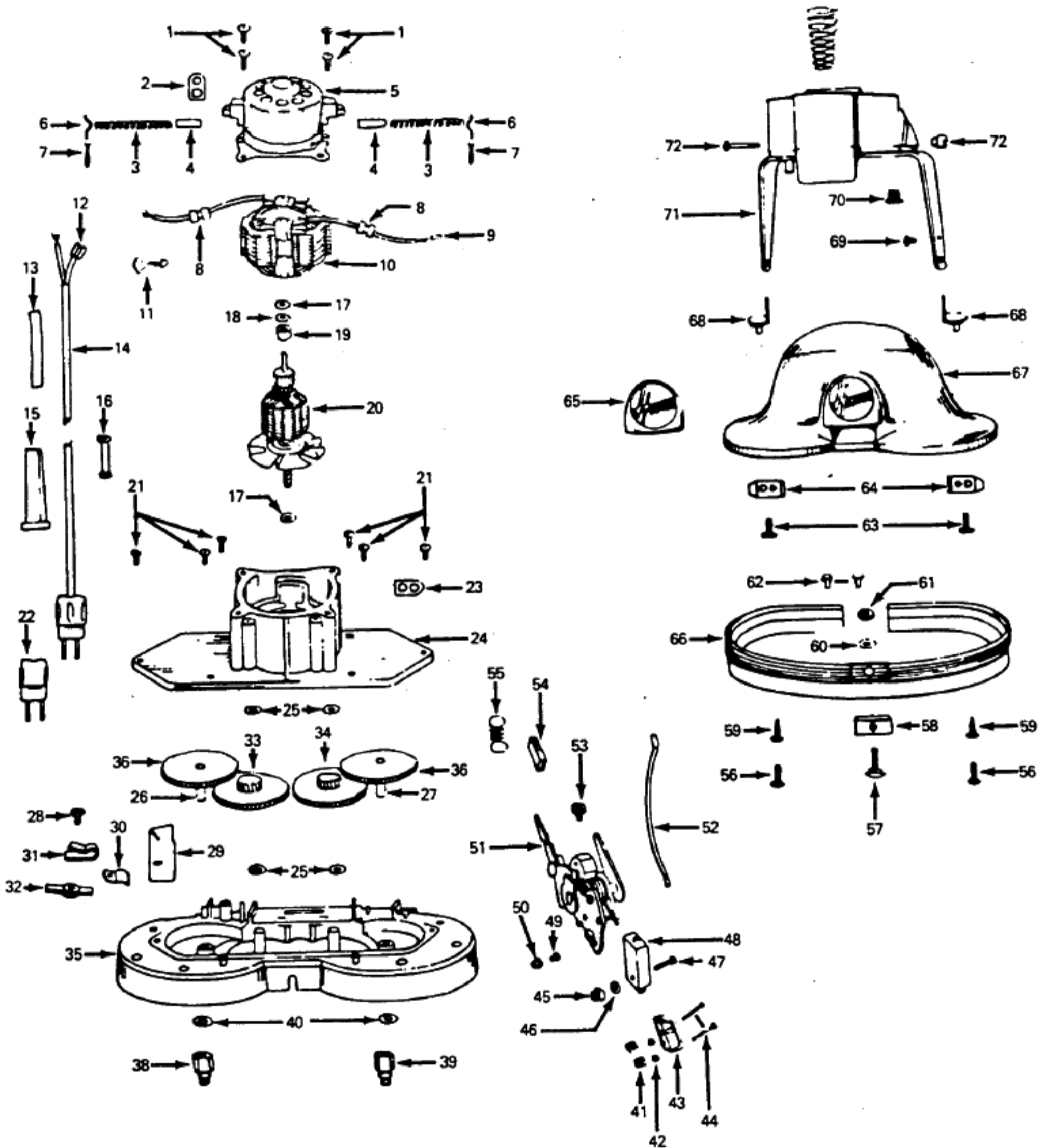

Motor & Housing

Models 5130, 5131, 5137, 5350, 5460, 5466, 5468

Ref.	Part	No.	No.	Ref.	Part	No.	No.
Description				Description			
1	17001FW	*	Screw	43	35589	+	Switch
2	13190	+*	Lead Wire Holder	44	12892	*	Screw - Machine
3	49423	+	Motor Brush Spring	45	21388105	+*	Nut - Special
4	49351	+	Motor Brush	46	21312761	*	Washer
5	42197002		Motor Cap Assem.	47	12892	*	Screw - Machine
6	49397	+*	Retainer	48	19512AH		Switch
7	49435	+*	Pin	49	14360	+*	Eyelet
8	49379	+	Lead Wire Collar	50	14377	+*	Switch Insulator
9	14197	+*	Terminal	51	35676	+	Bail Mounting Bracket Assem.
10	23444		Field Assem.	52	12574	+	Lead Wire - By Foot
11	48969	*	Wire Nut	53	49429	+*	Screw
12	160356	*	Terminal	54	34207AG		Foot Pad
13	48262A	+	Cord Cover Tube	55	12891		Handle Control Lever Spring
14	46363338		Attach. Cord	56	49188	+*	Screw
15	12229JM	+	Cord Protector	57	12548	+	Carriage Bolt
16	14504	+	Bail Socket Insulator	58	49403	+	Furniture Guard Retainer
17	49407	+	Washer	59	12738	+*	Screw
18	15865	*	Washer	60	12236	+*	Washer
19	49344	+*	Insulator	61	15673	*	Hex Nut
20	23445		Armature	62	49571AY	+	Rivet
21	49417AZ	+*	Screw	63	44099	+*	Screw
22	35380		Service Plug Assem.	64	47779	+	M. H. Attach. Plate
23	45517	*	Wire Holder	65	35581	+	Nameplate
24	12165		Gear Cover Assem.	66	23469A	+	Furniture Guard - 5460, 5466, 5468
25	21312724	*	Washer		23401A	+	Furniture Guard - 5130, 5131, 5137, 5350 (Wide)
26	168402		Brush Shaft & Insert - R.H.	67	23450B	+	Hood Assem.
27	168403		Brush Shaft & Insert - L.H.	68	19978BG	+	Ball Arm Retainer
28	14378	+*	Screw	69	49433	+*	Screw
29	14367	+	Cord Insulator	70	14491	+	Snap Bushing
30	34312011	*	Clip - Early Model	71	35644CC	+	Ball - 5460, 5466, 5468
31	12910		Cord Clamp - Late Model		35605A	+	Bail Assem. - 5103, 5131, 5137, 5350
32	49388AY	+	Bail Shaft - R.H.	72	48294AW		Handle Bolt & Nut
33	35675BZ		Idler Gear - R.H. (Black)				
34	35674		Idler Gear - L.H.				
35	42273011		Gear Housing Comp.				
36	38541002		Brush Gear				
38	35583		Shaft & Nut - R.H.	14503	+	Insulating Tube - 5460, 5466, 5468	
39	35584	+	Shaft & Nut - L.H.	168505	+	Brush Shaft Bushing	
40	21312756	*	Washer	12622	*	Plastic Washer - Used with Bearing 168505	
41	14199	+*	Nut				
42	14287	+	Lock Washer				

ITEMS NOT ILLUSTRATED

Polisher Accessories

Models 5020, 5130, 5131, 5137, 5200, 5240, 5350, 5450, 5460, 5466, 5468, 5476

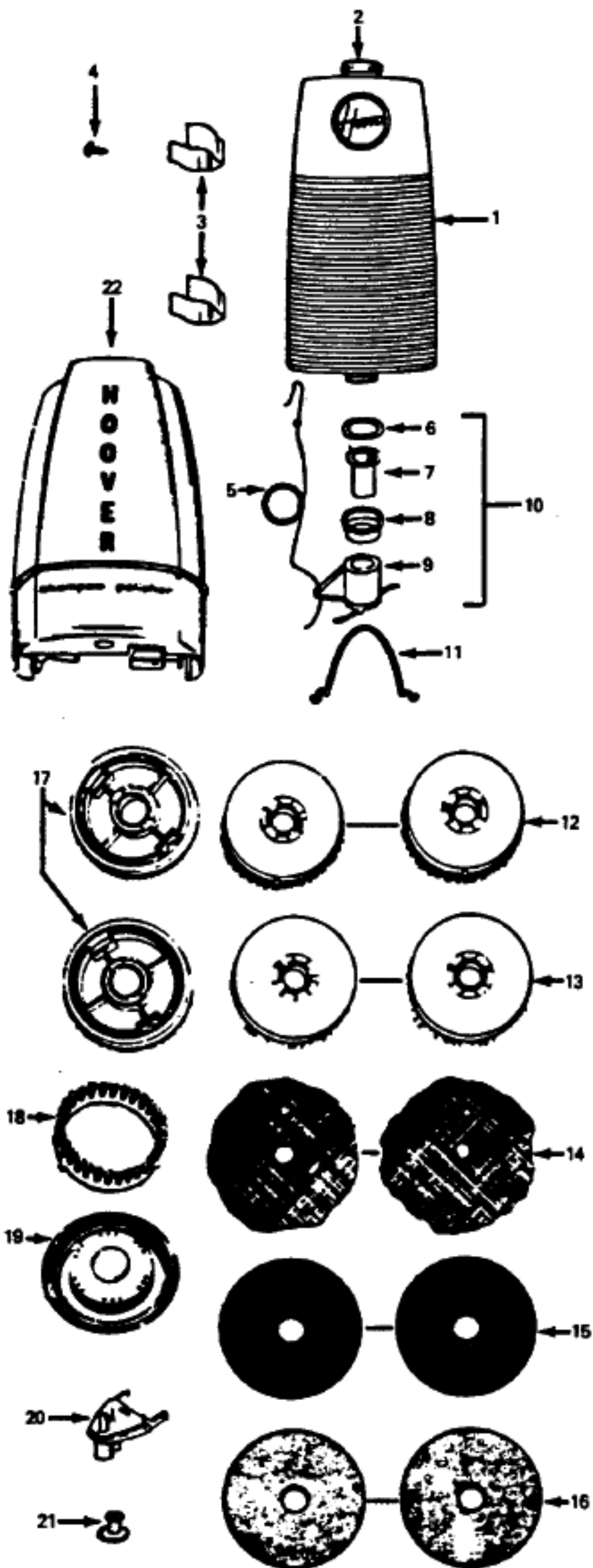

Ref. Description	Part No.	No.	No.
1	14464BA	+	Liquid Dispenser Tank - 1-1/2 Qt.
	18891BZ	+	Liquid Dispenser Tank - 1 Qt..
2	14486JM	+	Tank Cap
3	49482JM	+	Clamp Spring Clip
4	160548	+*	Screw
5	35413	+	Pull Cord, Hook & Ring Assem.
6	49539	+*	Gasket
7	35412	+	Valve Body
8	49490	+	Cap
9	35415	+	Valve Sleeve & Hose Assem.
10	43516003	+	Valve Assem.
11	35576	+	Hose Guide
12	35354		Floor Polisher Brush - Models B
	35580	+	Waxing & Scrubbing Brushes - Models A
13	35613		Polishing Brush - Models A
	35354		Polishing Brush - Models B
14	13197		High Lustre Pads, Pair - Models A
	13198	+	High Lustre Pads, Pair - Models B
15	48432014		Felt Buffing Pads, Pair - Models A
	13194	+	Felt Polishing Pads, Pair - Models B
16	13195		C. & W. Pads, Pair - Models A
	13196	+	C. & W. Pads, Pair - Models B
17	15116		Rug Shampoo Brush & Body - Models A
18	35419	+	Rug Shampoo Brush - Models B
19	35418	+	Rug Shampoo Body - Models B
	35384	+	Rug Shampoo Assem. - Models B
20	15217HH	+	Foam Wax Dispenser - Models A
21	13131		Plastic Fastener - Models A
	13132	+	Plastic Fastener - Models B
22	35460BB	+	Detergent Tank - 5200, 5468, 5476
	35460G	+	Detergent Tank - 5460, 5466

ITEMS NOT ILLUSTRATED

35575	+	Can Clamp Lever Assem.
35656	+	Spring for 35575
23067	+	Rug Applicator - 5020, 5450
161084		Steel Wool Pads, Pair - Models A

Models A - 5130, 5131, 5137, 5200, 5350, 5460, 5466, 5468, 5476
 Models B - 5020, 5240, 5450