

This Owner's Manual is provided and hosted by [Appliance Factory Parts](http://ApplianceFactoryParts.com).



# Electrolux FTW3011KW0 Owner's Manual

[Shop genuine replacement parts for Electrolux FTW3011KW0](#)

*Frigidaire*  
Appliance Parts Catalog

Product No.	FTW3011KW0
Market	North America
Color	white
Volts	120
Wiring Diagram	137155300
Owner's Guide	137153200
Installation Instructions	137153100
Energy Guide	137152300

**Electrolux**  
Electrolux Major Appliances  
North & Latin America  
P.O. BOX 212278  
AUGUSTA, GA 30917

Publication No.  
5965639375  
08/05/04  
(EN)SERVICE/WTC)  
381

TOP-LOAD WASHING  
MACHINE

Model No.  
FTW3011K

Copyright © 2009 Electrolux Home Products, Inc.  
All rights reserved.

[Find Your Electrolux Dryer Parts - Select From 57 Models](#)

----- Manual continues below part list -----

## Available Replacement Parts for Electrolux FTW3011KW0

<a href="#">134737100</a>	DAA TRANSMISSION
<a href="#">134936800</a>	LOCK AFTERMARKET
<a href="#">WV-2</a>	UNIV WASHER WATER VALVE WITH THERMISTOR

---

*Frigidaire*<sup>®</sup>

## Use & Care Guide

Washer

## Guide d'utilisation et d'entretien

Laveuse

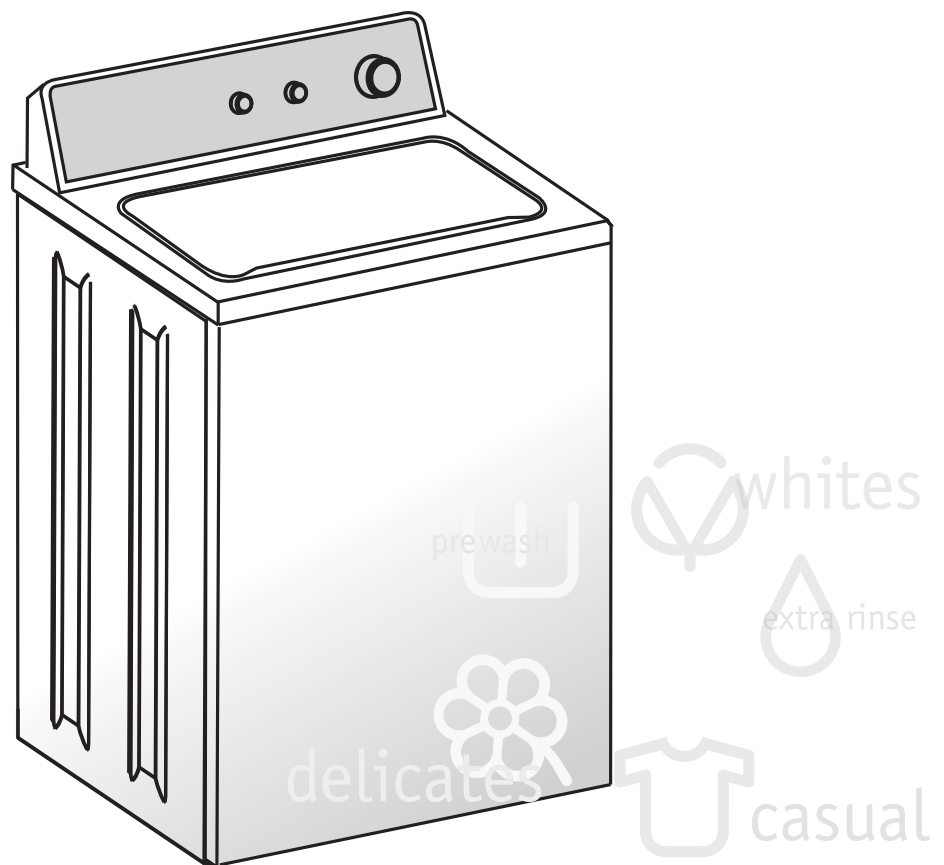

---

## Table of Contents

Product Registration.....	2	Winterizing.....	10
Important Safety Instructions.....	2-3	Common Washing Problems.....	10-11
Washing Procedures.....	4-5	Avoid Service checklist.....	11-12
Operating Instructions.....	6-7	Warranty.....	13
Stain Removal Guide.....	8-9	Notes.....	14
Care and Cleaning.....	9	Français.....	15

---

## Product Record

### **Read and Save These Instructions Record Your Model and Serial Numbers**

The model and serial numbers of your washer are found on the washer serial plate located on the washer lid. Record and retain these numbers.

**Model Number** \_\_\_\_\_

**Serial Number** \_\_\_\_\_

**Purchase Date** \_\_\_\_\_

Read all instructions before using this appliance. This book contains valuable information about:

- Operation
- Care
- Service

Keep it in a safe place.

This Use and Care Guide provides general operating instructions for your dryer. It also contains information about features for several other models. Your washer may not have every feature included.

Use the washer only as instructed in this *Use & Care Guide*.

---

## Important Safety Instructions

**⚠ WARNING** To reduce the risk of fire, electrical shock, or injury to persons when using this washer, comply with the basic warnings listed below. Failure to comply with these warnings could result in serious personal injuries. You can be killed or seriously injured if you don't follow these Important Safety Instructions:

### **Recognize safety symbols, words and labels**

Safety items throughout this manual are labeled with a WARNING or CAUTION based on the risk type as described below:

**⚠ WARNING** This symbol alerts you to situations that may cause serious body harm, death or property damage.

**⚠ CAUTION** This symbol alerts you to situations that may cause bodily injury or property damage.

**Save these instructions for future reference.**

**NOTE** The instructions appearing in this Use and Care Guide are not meant to cover every possible condition and situation that may occur. Common sense and caution must be practiced when installing, operating and maintaining any appliance.

### **PREVENT FIRE**

- Do not wash items that have been previously cleaned in, soaked in, or spotted with gasoline, cleaning solvents, kerosene, cooking oils, waxes, etc. Do not store these items on or near the washer. These substances give off vapors or chemical reactions that could ignite or explode.
- Do not put oily or greasy rags or clothing on top of the washer. These substances give off vapors that could ignite the materials.
- Do not add gasoline, cleaning solvents, or other flammable or explosive substances to the wash water. These substances give off vapors that could ignite or explode.
- Under certain conditions, hydrogen gas may be produced in a hot water system that has not been used for 2 weeks or more. HYDROGEN GAS IS EXPLOSIVE. If the hot water system has not been used for such a period, before using the washer, turn on all hot water faucets and let the water flow from each for several minutes. This will release any accumulated hydrogen gas. Hydrogen gas is flammable; do not smoke or use an open flame during this time.
- Do not store or use gasoline or other flammable vapors or liquids in the vicinity of this or any other appliance.
- Failure to comply with these warnings could result in fire, explosion, serious bodily injury and/or damage to the rubber or plastic parts of the washer.

## Important Safety Instructions, continued

### PROTECT CHILDREN

- Do not allow children to play on or in the washer. Close supervision of children is necessary when the washer is used near children. As children grow, teach them the proper, safe use of all appliances.
- Destroy the carton, plastic bag and other packing materials after the washer is unpacked. Children might use them for play. Cartons covered with rugs, bedspreads or plastic sheets can become airtight chambers.
- Keep laundry products out of children's reach. To prevent personal injury, observe all warnings on product labels.
- Before the washer is removed from service or discarded, remove the washer door to prevent accidental entrapment.
- Failure to comply with these warnings could result in serious personal injuries.

### PREVENT INJURY

- To prevent shock hazard and assure stability during operation, the washer must be installed and electrically grounded by a qualified service person in accordance with local codes. Installation instructions are packed in the washer for installer's reference. Refer to *INSTALLATION INSTRUCTIONS* for detailed grounding procedures. If the washer is moved to a new location, have it checked and reinstalled by a qualified service person.
- To prevent personal injury or damage to the washer, the electrical power cord of the washer must be plugged into a properly grounded and polarized 3-prong outlet. The third grounding prong must never be removed. Never ground the washer to a gas pipe. Do not use an extension cord or an adaptor plug.
- Follow package directions when using laundry products. Incorrect usage can produce poisonous gas - resulting in serious injury or death.
- Do not combine laundry products for use in 1 load unless specified on the label.
- Do not mix chlorine bleach with ammonia or acids such as vinegar.

**⚠ WARNING - HARMFUL VAPOR HAZARD** - Do not use or mix liquid chlorine bleach with other household chemicals such as toilet cleaners, rust removers, acid or products containing ammonia. These mixtures can produce dangerous fumes which can cause serious injury or death.



### PREVENT INJURY AND DAMAGE TO THE WASHER

To prevent serious personal injury and damage to the washer:

- All repairs and servicing must be performed by an authorized servicer unless specifically recommended in this Use & Care Guide. Use only authorized factory parts.
- Do not tamper with controls.
- Do not install or store the washer where it will be exposed to the weather.
- Do not install on carpet. Install washer on a solid floor. It may be necessary to reinforce the floor to prevent vibration or movement.
- To reduce the risk of electric shock, disconnect this appliance from the power supply before attempting any user maintenance. Turning the controls to the OFF position does not disconnect this appliance from the power supply.
- To prevent injury, do not reach into the washer while parts are moving. Before loading, unloading or adding items, push in the cycle selector knob and allow the drum to coast to a complete stop before reaching inside.
- This washer is equipped with an electrical overload protector. The motor will stop if it becomes overheated. The washer will automatically restart after a cool down period of up to 30 minutes, if the washer has not been manually turned off during this time.
- Failure to comply with these warnings could result in serious personal injuries.

### ⚠ WARNING - FIRE/ELECTRICAL SHOCK HAZARD -

Avoid fire hazard or electrical shock. Do not use an adaptor plug or extension cord or remove grounding prong from electrical power cord. Failure to follow this warning can cause serious injury, fire or death.

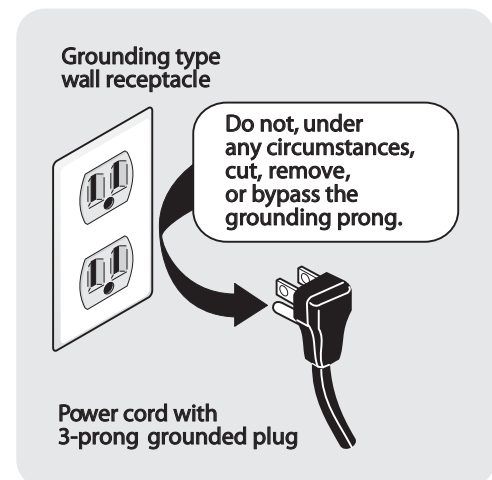

## Washing Procedures

**⚠ WARNING** To reduce the risk of fire, electric shock or injury to persons, read the IMPORTANT SAFETY INSTRUCTIONS in this *Use and Care Guide* before operating your washer.

### 1 Sort laundry into loads that can be washed together.

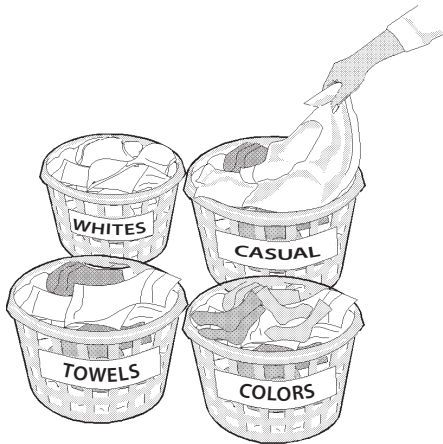

- Sort items by recommended cycle and water temperature.
- Separate white, light and colorfast items from dark and non-colorfast items.
- Separate items that shed lint from items that attract lint. Casual, synthetic, knit, and corduroy items will pick up lint from towels, rugs, and chenille bedspreads.
- Separate heavily soiled items from lightly soiled items.
- Separate lacy, sheer, loosely knit, or delicate items from durable items.
- Do not machine wash items containing fiberglass. Small particles of fiberglass left in the drum may transfer to fabrics in other loads and cause skin irritation.

### 2 Prepare items for washing.

- Empty pockets.

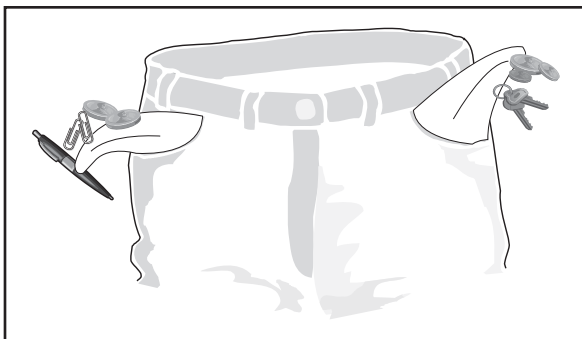

- Brush off lint and dirt. Shake out rugs and beach towels.
- Close zippers, fasten hooks, tie strings and sashes, and remove non-washable trims and ornaments.
- Mend rips and tears to prevent further damage during washing.
- Turn knit items inside out to prevent pilling.

- Place delicate and small items such as bras, hosiery and baby socks in a mesh bag.

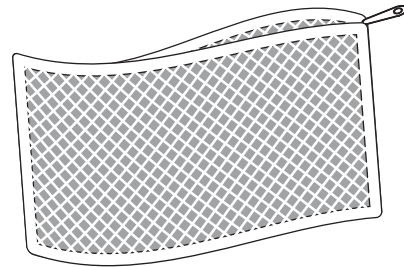

(Mesh bag not included.)

### 3 Pretreat stains and heavy soil.

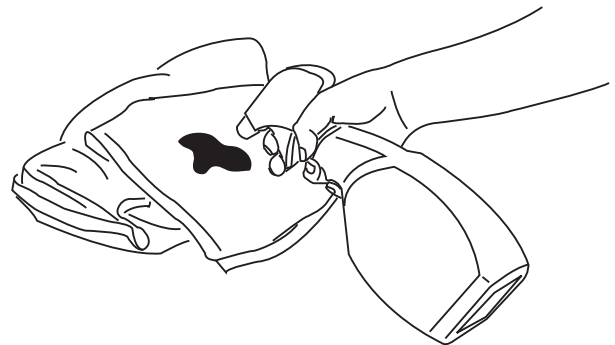

- See Stain Removal Guide in this guide for safe, successful stain removal instructions.

### 4 Add a measured amount of detergent to the wash tub before adding the laundry load.

Follow detergent manufacturer's directions. The amount required depends on type of detergent, load size and soil level, and water hardness.

### 5 If desired, add liquid bleach to bleach dispenser.

Before adding the wash load, add liquid bleach to bleach dispenser located in left front corner under the lid:

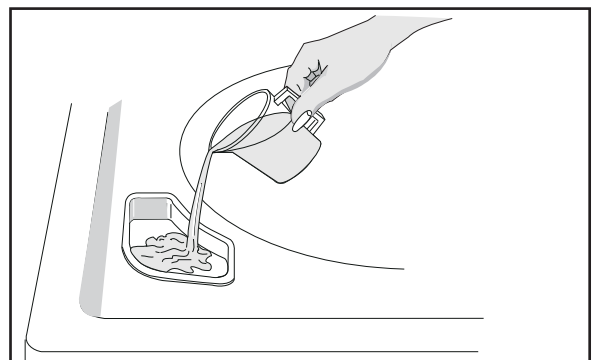

- Refer to bleach manufacturer's directions for quantity to add.
- Then add 1 cup (240 ml) water to flush the dispenser.
- Do not use powdered bleach in the bleach dispenser. Add powdered bleach to the empty tub.

## Washing Procedures, continued

### 6 Add laundry load to washer.

- Dry load level should not be higher than the top of the agitator vanes. Do not overload the washer.

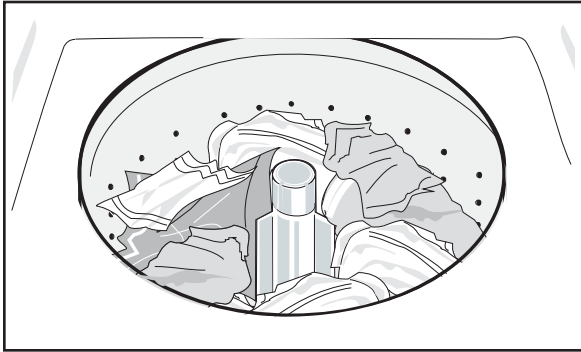

- Do not put items on top of agitator or wrap them around it. Load items evenly.
- Combine large and small items in a load. Load large items first. Large items should not be more than half the total wash load.
- When washing a single heavy item, add 1 or 2 towels to balance the load.

### 7 If desired, add liquid fabric softener to fabric softener dispenser (available on some models).

**For models with a built-in dispenser:**

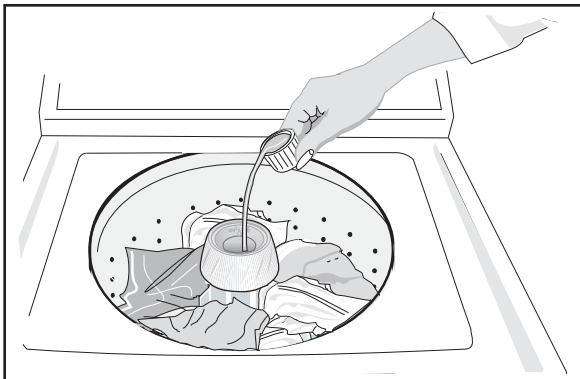

- Add liquid softener to the dispenser, following fabric softener label directions. DO NOT use granular detergent in this dispenser.
- Add water to bring liquid level to fill line on dispenser cap.
- Remove the dispenser from the agitator after each use. Rinse both cap and cup with warm water. Replace dispenser in the agitator.
- Do not use bleach in this dispenser.

**NOTE** To separate cap from cup, put thumb into dispenser and push against side of cup (see picture to the left). After cleaning, push cap and cup firmly together. Replace dispenser by lining up the ribs and grooves and snapping it into position.

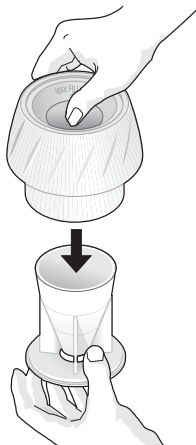

If a build-up of fabric softener occurs, clean with hot water. **DO NOT REMOVE SERVICE CAP FOUND INSIDE THE AGITATOR POST.**

**For models without a fabric softener dispenser,** follow fabric softener label directions. Add diluted fabric softener to the final rinse. **Do not pour fabric softener directly on the wash load.**

### 8 Select cycle and settings according to type, size and soil level of each load.

See **Operating Instructions** on next page.

### 9 Start the washer.

Close the washer lid and pull out the cycle selector knob. The washer will not fill with water, agitate or spin when the lid is open, and will only start to do so if the lid is closed. The washer will automatically turn off if the lid is lifted during agitation to add a garment or laundry product after the cycle has begun. The washer will resume the cycle where it left off when the lid is again closed. If the washer doesn't agitate when the lid is closed, check the cycle selector knob. It may have accidentally been pushed in when the lid was opened. Pull out the knob to restart the washer.

- To stop the washer during agitation, push in the cycle selector knob.
- Do not stop and restart washer during a spin when using the fabric softener dispenser.
- To change a cycle after it has started, push in the cycle selector knob. Turn it clockwise to the desired setting. Pull out the knob to restart the washer.

### 10 Remove items when the cycle is completed.

The lid must be closed during spin. For your safety, the lid locks when pre-pumping and remains locked when pumping and spinning. It will remain locked for about 2-3 minutes after the cycle ends and the tub has come to a complete stop.

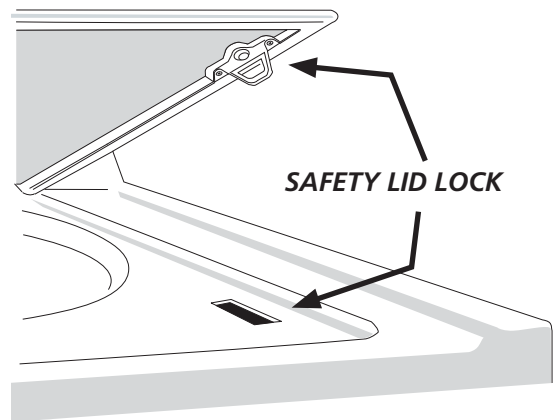

- To open the lid during a spin, push in the cycle selector knob and wait about 2-3 minutes for the lid lock to release. **Do not force open the locked lid.**
- Place washed items in automatic dryer, line dry, or dry flat as directed by fabric care label. Excess wrinkling, color transfer or odors may develop in items left in the washer after the cycle has ended.

**CAUTION** To avoid serious personal injury, do not operate washer if safety lid lock is missing, damaged or operating improperly.

# OPERATING INSTRUCTIONS

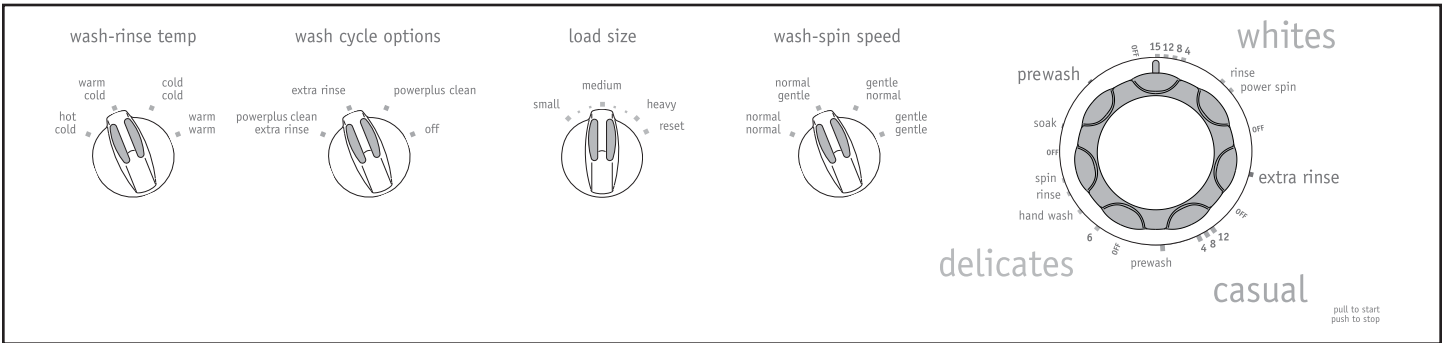

This manual covers many models and not all cycles, options, or features listed are available on every model. Console shown above for reference only. Your model may differ.

## Cycle Selection

Push in and turn the Cycle Selector knob clockwise to the desired cycle.

**For best results**

Follow the fabric care label instructions on items to be washed.

The **Whites**, **Casual** and **Delicates** cycles progress through wash agitation, drain and spin with a spray rinse, rinse agitation, and a spray rinse during the final spin.

### WHITES

- This cycle provides up to 15 minutes of normal agitation and a fast spin for most fabrics.
- **Power Spin** provides 12 minutes of spin for maximum removal of water. This conserves energy by reducing drying time.

### EXTRA RINSE

- Use the **Extra Rinse** cycle after any complete wash cycle when an additional deep rinse may be needed to remove excess detergent and soil. It provides 3 minutes of rinse agitation in cold water, followed by a spray rinse at the selected rinse water temperature during spin.
- If desired, add liquid fabric softener to the water (not the fabric softener dispenser) or use a softener sheet in the dryer. DO NOT pour fabric softener directly onto the load.

### CASUAL

- This cycle provides up to 12 minutes of normal agitation and a fast spin for cottons and blends with a no-iron finish. A cool down spray rinse helps reduce wrinkling.
- Select the **Casual Prewash** setting to help loosen soil and remove stains before washing. Add the recommended amount of detergent and other laundry products desired to tub. Add load. Select a cold water rinse and appropriate load size. Load will agitate 4 minutes, drain and spin. Follow **Casual Prewash** with a complete **Casual** cycle and a half dose of detergent.

### DELICATES

- Provides 6 minutes of gentle agitation and a slow spin for the gentle care of knits and delicate items.
- Select the **Hand Wash** setting for 3 minutes of gentle agitation and a slow spin for the gentle care of hand washable items.

## SOAK/PREWASH

### Soak

- Use **Soak** to treat heavily soiled or stained items. **Soak** provides 3 minutes of agitation and 12 minutes of soaking time in cold water. The load then advances into the **Prewash** portion of the cycle.
- Use the amount of detergent recommended for a normal wash cycle. If desired, use a bleach or a soaking agent safe for the fabric.
- Follow **Soak** with a complete wash cycle using a half dose of detergent.

### Prewash

- Use **Prewash** to loosen soils before washing and to help remove protein-based stains such as milk, grass and blood. **Prewash** provides 3 minutes of agitation before the water drains.
- Use the amount of detergent recommended for a normal wash cycle.
- The **Prewash** water temperature is the same as the wash water temperature selected. To avoid setting protein stains, select **cold** water.
- Follow **Prewash** with a complete wash cycle using a half dose of detergent.

## Cycle Settings

### WASH-SPIN SPEED (on select models)

Select the agitation and spin speed combination suitable for each load. The following chart suggests wash/spin speeds for typical wash loads.

Fabric Type	Wash/Spin Speeds
Regular/Whites	Normal/Normal
Perm Press/Colors	Normal/Gentle
Knits	Gentle/Normal
Delicates / Hand washables	Gentle/Gentle
Washable woolens	Gentle/Gentle

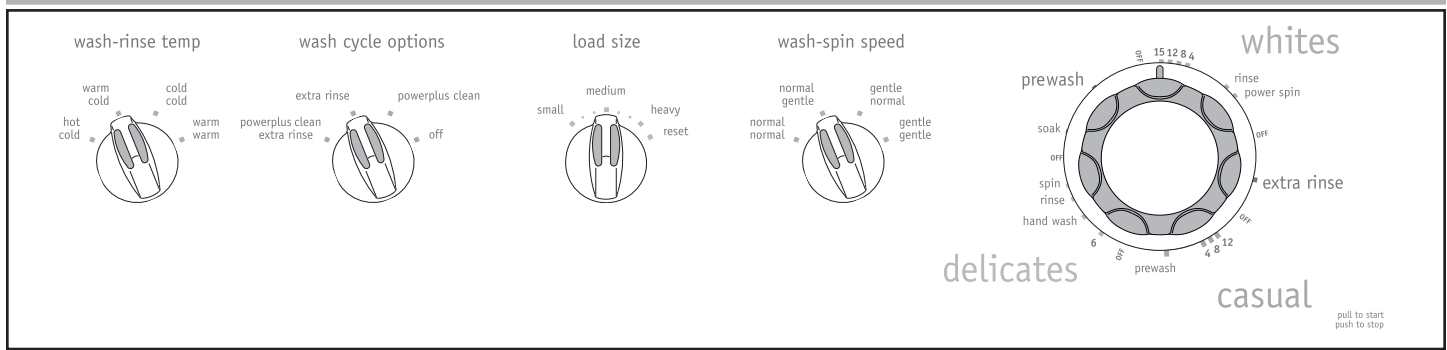

This manual covers many models and not all cycles, options, or features listed are available on every model. Console shown above for reference only. Your model may differ.

## Cycle Settings, continued

### LOAD SIZE

- Turn the **Load Size** knob to select a water level appropriate for the load size. For best results, DO NOT overload. Add items loosely to the tub. The dry load should not be higher than the top of the agitator vanes. There should be enough water in the tub for items to move freely.
- To increase the water level after the wash cycle begins, turn the **Load Size** knob to **Reset** and hold. When water begins to enter the tub, turn the knob to the desired setting.

### WASH/RINSE TEMPERATURE

- Turn the **Wash/Rinse Temp** knob to select the wash water temperature suitable for the fiber content and soil level of each load. A cold water rinse saves energy and reduces wrinkling.
- If a cold rinse is selected, the washer will fill with cold water during rinse, followed by a cold spray rinse during final spin. If a warm rinse is selected, the washer will fill with cold water during rinse, followed by a warm spray rinse during final spin.
- To conserve energy, the hot wash water is regulated. Warm and cold wash and rinse water temperatures are not regulated.
- The following chart suggests wash/rinse temperatures for basic fabric types.

Fabric Type	Wash/Rinse Temperature
Heavily soiled white/colorfast cotton, perm press	Hot/Cold
Normally soiled white/colorfast cotton, perm press	Warm/Cold
Lightly soiled cottons and perm press, noncolorfast fabrics, knits, delicates, hand washables	Cold/Cold
Washable woolens	Warm/Warm

## Cycle Options

### POWERPLUS CLEAN (on select models)

Select **PowerPlus Clean** to automatically advance a load from the **Soak** or **Prewash** setting into the **Whites** wash and **Extra Rinse** cycles.

1. Add the measured amount of detergent to wash tub, then add wash load.

2. Select appropriate **Wash/Rinse Temperature**, **Load Size**, and **Wash/Spin Speed**.
3. Select **PowerPlus Clean** under **Wash Cycle Options**.
  - To use a cycle other than **Whites** after the **Soak** or **Prewash** settings, select **OFF** and manually advance cycle selector to cycle desired.
4. Fill fabric softener dispenser with the recommended amount of **LIQUID** detergent. Add water to bring liquid level to fill line on dispenser cap.
  - When selecting **PowerPlus Clean**, the fabric softener dispenser must be filled with diluted liquid detergent at the beginning of the **Soak** or **Prewash** setting. The detergent for the **Whites** cycle will then be dispensed after the spin in Prewash.
  - DO NOT use powdered detergent in the dispenser.
  - Clean the fabric softener dispenser thoroughly after each use. Fabric softener and liquid detergent should not be mixed.
5. Set the cycle selector at **Soak** or **Prewash** and pull knob to start. The washer will provide **Soak** or **Prewash** as selected. It then automatically advances to the full **Whites** cycle and **Extra Rinse** cycle.

### EXTRA RINSE

Select **Extra Rinse** to automatically add an additional deep rinse to the **Whites** cycle. It provides 3 minutes of rinse agitation in cold water, followed by a spray rinse at the selected rinse water temperature during spin. If desired, add liquid fabric softener to this rinse (not the fabric softener dispenser) or use a softener sheet in the dryer. DO NOT pour fabric softener directly onto the load.

## Energy Saving Tips

- Wash full loads. Oversize loads use extra energy. Undersized loads waste energy.
- When small wash loads cannot be avoided, use lower water levels.
- Select the appropriate cycle and time for each load. Shorten wash times for lightly soiled loads.
- To reduce drying time, select a fast spin speed to remove more water from heavy items such as towels and jeans.
- Use warm water to wash most loads. Limit hot water washes to heavily soiled and white loads. Use cold water for lightly soiled items and rinsing.
- Operate the washer in early morning and late evening when utility demands are low.
- Follow proper laundry procedures to avoid rewashing.

## Safe Stain Removal Procedures

To reduce the risk of fire or serious injury to persons or property, comply with the basic warnings listed below:

- Read and comply with all instructions on stain removal products.
- Keep stain removal products in their original labeled containers and out of children's reach.
- Thoroughly wash any utensils used.
- Do not combine stain removal products, especially ammonia and chlorine bleach. Dangerous fumes can result.
- Never wash items which have been previously cleaned in, washed in, soaked in or spotted with gasoline, dry cleaning solvents or other flammable or explosive substances because they give off vapors that could ignite or explode.
- Never use highly flammable solvents, such as gasoline, inside the home. Vapors can explode on contact with flames or sparks.

**⚠ WARNING - HARMFUL VAPOR HAZARD -**  
Do not use or mix liquid chlorine bleach with other household chemicals such as toilet cleaners, rust removers, acid or products containing ammonia. These mixtures can produce dangerous fumes which can cause serious injury or death.



## For Successful Stain Removal:

- Remove stains promptly.
- Determine the kind of stain, then follow the recommended treatment in the stain removal chart on the next page.
- To pretreat stains, use a prewash product, liquid detergent, or a paste made from powder detergent and water.
- Use cold water on unknown stains because hot water can set stains.
- Consult care label instructions for treatments to avoid on specific fabrics.
- Check for colorfastness by testing stain remover products on an inside seam.
- Rinse and wash items after stain removal.



## Stain Removal Suggestions

STAIN	TREATMENT
Adhesive tape, chewing gum, rubber cement	Apply ice. Scrape off excess. Place stain face down on paper towels. Saturate with prewash stain remover or nonflammable dry cleaning fluid.
Baby formula, dairy products, egg	Use product containing enzymes to pretreat or soak stains. Soak for 30 minutes or more. Wash.
Beverages (coffee, tea, soda, juice, alcoholic beverages)	Pretreat stain. Wash using cold water and bleach safe for fabric.
Blood	Rinse with cold water. Rub with bar soap. Or, pretreat or soak with product containing enzymes. Wash using bleach safe for fabric.
Candle wax, crayon	Scrape off surface wax. Place stain face down between paper towels. Press with warm iron until wax is absorbed. Replace paper towels frequently. Treat remaining stain with prewash stain remover or nonflammable dry cleaning fluid. Hand wash to remove solvent. Wash using bleach safe for fabric.
Chocolate	Pretreat or soak in warm water using product containing enzymes. Wash using bleach safe for fabric.
Collar or cuff soil, cosmetics	Pretreat with prewash stain remover or rub with bar soap.
Dye transfer on white fabric	Use packaged color remover. Wash using bleach safe for fabric.
Grass	Pretreat or soak in warm water using product containing enzymes. Wash using bleach safe for fabric.
Grease, oil, tar (butter, fats, salad dressing, cooking oils, car grease, motor oils)	Scrape residue from fabric. Pretreat. Wash using hottest water safe for fabric. For heavy stains and tar, apply nonflammable dry cleaning fluid to back of stain. Replace towels under stain frequently. Rinse thoroughly. Wash using hottest water safe for fabric.
Ink	Some inks may be impossible to remove. Washing may set some inks. Use prewash stain remover, denatured alcohol or nonflammable dry cleaning fluid.
Mildew, scorch	Wash with chlorine bleach if safe for fabric. Or, soak in oxygen bleach and hot water before washing. Badly mildewed fabrics may be permanently damaged.

## Stain Removal Suggestions, continued

STAIN	TREATMENT
Mud	Brush off dry mud. Pretreat or soak with product containing enzymes.
Mustard, tomato	Pretreat with prewash stain remover. Wash using bleach safe for fabric.
Nail polish	May be impossible to remove. Place stain face down on paper towels. Apply nail polish remover to back of stain. Repeat, replacing paper towels frequently. Do not use on acetate fabrics.
Paint, varnish	WATER BASED: Rinse fabric in cool water while stain is wet. Wash. Once paint is dry, it cannot be removed. OIL BASED AND VARNISH: Use solvent recommended on can label. Rinse thoroughly before washing.
Perspiration	Use prewash stain remover or rub with bar soap. Rinse. Wash using nonchlorine bleach in hottest water safe for fabric.
Rust, brown or yellow discoloration	Use rust remover safe for fabric. Do not use chlorine bleach because it may intensify discoloration.
Shoe polish	LIQUID: Pretreat with a paste of powder detergent and water. PASTE: Scrape residue from fabric. Pretreat with prewash stain remover or nonflammable dry cleaning fluid. Rinse. Rub detergent into dampened area. Wash using bleach safe for fabric.
Tomato	Pretreat with prewash stain remover. Wash using bleach safe for fabric.
Urine, vomit, mucus, feces	Pretreat or soak in product containing enzymes. Wash using bleach safe for fabric.
Wine	Pretreat or soak in cold water. Wash in hottest water and bleach safe for fabric

## Care and Cleaning

### Inside

- Remove items from the washer as soon as the cycle ends. Excess wrinkling, color transfer, and odors may develop in items left in the washer.
- Dry the washer top, the area around the lid opening, and the underside of the lid. These areas should always be dry before the lid is closed.
- Before cleaning the washer interior, unplug the electrical power cord to avoid electrical shock hazards.
- When extremely soiled items have been washed, a dirty residue may remain on the tub. Remove this by wiping the tub with a nonabrasive household cleanser. Rinse thoroughly with water.
- The agitator or tub may become stained from fabric dye. Clean these parts with a nonabrasive household cleanser. This prevents dye transfer to future loads.

### Outside

- When washing is completed, wipe top and sides of washer with a damp cloth. Turn water faucets off to prevent pressure build-up in the hoses.
- Clean the cabinet with mild soap and water. Never use harsh, gritty or abrasive cleansers
- If the cabinet becomes stained, clean with diluted chlorine bleach (1 part bleach to 8 parts water). Rinse several times with clear water.
- Remove glue residue from tape or labels with a mixture of warm water and mild detergent. Or, touch residue with the sticky side of tape.
- Before moving the washer, place a strip of cardboard or thin fiberboard under the front leveling legs to prevent damage to the floor.

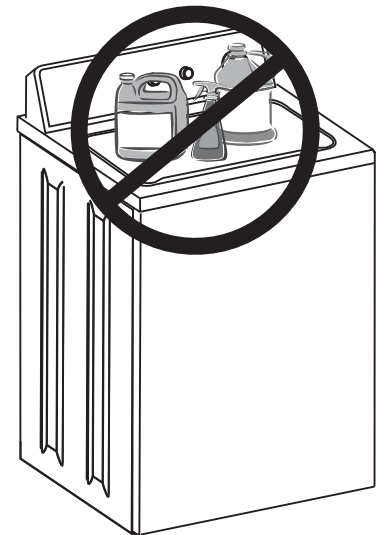

**IMPORTANT** Do not store or place laundry products on top of washer at any time. They can damage the finish or controls.

## Winterizing Instructions

**IMPORTANT** If the washer is stored in an area where freezing can occur or moved in freezing temperatures, follow these winterizing instructions to prevent damage to the washer:

1. Turn off water supply faucets.
2. Disconnect hoses from water supply and drain water from hoses.
3. Plug electrical cord into a properly grounded electrical outlet.
4. Add 1 gallon (3.8 L) nontoxic recreational vehicle (RV) antifreeze to empty wash drum. Close lid.
5. Set cycle selector knob at a spin setting. Pull out knob and let washer spin for 1 minute to drain out all water. Not all of the RV antifreeze will be expelled.
6. Push in knob, unplug electrical power cord, dry tub interior, and close lid.
7. Store washer in an upright position.
8. To remove antifreeze from washer after storage, run empty washer through a complete cycle using detergent. **Do not add wash load.**



## Common Washing Problems

Many washing problems involve poor soil and stain removal, residues of lint and scum, and fabric damage. For satisfactory washing results, follow these suggestions provided by The Soap and Detergent Association.

PROBLEM	POSSIBLE CAUSES	SOLUTIONS	PREVENTIVE MEASURES
Blue stains	<ul style="list-style-type: none"> <li>• Undiluted liquid detergent or fabric softener dispensed directly onto fabric.</li> </ul>	<ul style="list-style-type: none"> <li>• If caused by detergent, mix 1 cup (240 ml) white vinegar with 1 quart (.95 L) water in a plastic container. Soak item 1 hour. Rinse.</li> <li>• If caused by fabric softener, rub stains with bar soap. Wash.</li> </ul>	<ul style="list-style-type: none"> <li>• Avoid overfilling detergent and fabric softener compartments of dispenser.</li> </ul>
Discoloration, gray-ing	<ul style="list-style-type: none"> <li>• Not enough detergent.</li> <li>• Wash water temperature too low.</li> <li>• Incorrect sorting.</li> </ul>	<ul style="list-style-type: none"> <li>• Rewash with correct amount of detergent and hottest water safe for fabric.</li> <li>• Add bleach safe for fabric.</li> </ul>	<ul style="list-style-type: none"> <li>• Sort items by soil level and color.</li> <li>• Use correct amount of detergent, hottest water and bleach safe for fabric.</li> </ul>
Greasy, oily stains	<ul style="list-style-type: none"> <li>• Not enough detergent.</li> <li>• Undiluted liquid fabric softener poured directly on fabric.</li> </ul>	<ul style="list-style-type: none"> <li>• Treat with prewash stain remover or liquid detergent.</li> <li>• Increase detergent and water temperature. Rewash.</li> <li>• Rub fabric softener stains with bar soap.</li> </ul>	<ul style="list-style-type: none"> <li>• Use correct amount of detergent and hottest water safe for fabric.</li> <li>• Do not pour liquid fabric softener directly on fabric. See Operating Your, step 5.</li> </ul>
Holes, tears, or snags	<ul style="list-style-type: none"> <li>• Incorrect use of chlorine bleach.</li> <li>• Unfastened zippers, hooks, buckles.</li> <li>• Rips, tears and broken threads.</li> <li>• Overloading the washer.</li> <li>• Degradation of fabric.</li> </ul>	<ul style="list-style-type: none"> <li>• May be irreversible if rips, tears and seams cannot be mended.</li> </ul>	<ul style="list-style-type: none"> <li>• Never pour chlorine bleach directly on fabric.</li> <li>• Check condition of items before washing. See Operating Your, steps 2 and 5.</li> </ul>
Lint	<ul style="list-style-type: none"> <li>• Incorrect sorting.</li> <li>• Tissues left in pocket.</li> <li>• Overloading the washer.</li> <li>• Not enough detergent.</li> <li>• Undissolved detergent has left a residue resembling lint.</li> <li>• Static cling is attracting lint.</li> <li>• Load washed too long.</li> </ul>	<ul style="list-style-type: none"> <li>• Reduce load size. Rewash using correct water temperature, water level, and amount of detergent.</li> <li>• Add nonprecipitating water conditioner to wash water to remove detergent residue.</li> <li>• Add liquid fabric softener to final rinse.</li> <li>• Dry load in dryer.</li> <li>• Remove lint with lint brush or roller.</li> </ul>	<ul style="list-style-type: none"> <li>• See Operating Your, steps 1 and 2.</li> <li>• Do not overload washer.</li> <li>• Use correct temperature and amount of detergent, water and wash time.</li> </ul>
Pilling (Fibers ball up and cling to fabric.)	<ul style="list-style-type: none"> <li>• Pilling is normal with synthetic and permanent press fabrics. This is due to abrasion from normal wear.</li> </ul>	<ul style="list-style-type: none"> <li>• Use a lint brush or shaver to remove pills.</li> </ul>	<ul style="list-style-type: none"> <li>• Use fabric softener in the washer to lubricate fibers.</li> <li>• When ironing, use spray starch or fabric finish on collars and cuffs.</li> <li>• Turn items inside out to reduce abrasion.</li> </ul>

## Common Washing Problems, continued

PROBLEM	POSSIBLE CAUSES	SOLUTIONS	PREVENTIVE MEASURES
Residue or powder on dark items; Stiff, harsh fabrics.	<ul style="list-style-type: none"> <li>• Undissolved detergent.</li> <li>• Some granular detergents can combine with hard water minerals to form a residue.</li> <li>• Overloading the washer.</li> </ul>	<ul style="list-style-type: none"> <li>• Rewash load.</li> </ul>	<ul style="list-style-type: none"> <li>• Increase water temperature using hottest water safe for fabric.</li> <li>• Do not overload washer.</li> <li>• Use liquid detergent or use non-precipitating water conditioner with powder detergent.</li> </ul>
Wrinkling	<ul style="list-style-type: none"> <li>• Overloading the washer.</li> <li>• Incorrect wash cycle for wash load.</li> </ul>	<ul style="list-style-type: none"> <li>• Reduce load size.</li> <li>• Rinse in cold water with liquid fabric softener using the casual or delicate cycle.</li> </ul>	<ul style="list-style-type: none"> <li>• Do not overload washer.</li> <li>• Remove items from washer as soon as cycle is completed.</li> <li>• Use liquid fabric softener.</li> </ul>
Yellow buildup of body soil on synthetic fabrics	<ul style="list-style-type: none"> <li>• Agitation time too short.</li> <li>• Wash water temperature too low.</li> <li>• Not enough detergent.</li> </ul>	<ul style="list-style-type: none"> <li>• Soak in detergent booster or product containing enzymes.</li> <li>• Wash in hottest water safe for fabric using casual cycle.</li> <li>• Increase detergent.</li> <li>• Add bleach safe for fabric or treat with color remover.</li> </ul>	<ul style="list-style-type: none"> <li>• Select correct wash cycle.</li> <li>• Use correct amount of detergent.</li> <li>• Wash synthetics frequently using hot or warm water.</li> </ul>
Yellow or brown rust stains	<ul style="list-style-type: none"> <li>• Iron or manganese in water supply, water pipes, or water heater.</li> </ul>	<ul style="list-style-type: none"> <li>• To restore discolored load of whites, use rust remover safe for fabric.</li> <li>• Do not use chlorine bleach to remove rust stains. It may intensify discoloration.</li> </ul>	<ul style="list-style-type: none"> <li>• Use nonprecipitating water softener.</li> <li>• Before washing, run hot water for a few minutes to clear lines.</li> <li>• Drain water heater occasionally.</li> <li>• For an ongoing problem, install an iron filter in your water supply system.</li> </ul>

## Avoid Service Checklist

Before calling for service, review this list. It may save both time and expense. The list includes common occurrences that are not the result of defective workmanship or materials in this washer.

OCCURRENCE	POSSIBLE CAUSE	SOLUTION
<b>NOISE</b>		
"Clunking" or gear sounds.	A certain amount of "clunking" or gear sounds are normal in a heavy-duty washer.	This is normal.
Rattling and clanking noise.	Foreign objects such as coins or safety pins may be in drum or pump.	Stop washer and check drum. If noise continues after washer is restarted, objects may be in pump. Call your authorized servicer.
	Belt buckles and metal fasteners are hitting wash drum.	To prevent unnecessary noise and damage to tub, fasten fasteners and turn items inside out.
Thumping sound.	Heavy wash loads may produce a thumping sound. This is usually normal. If sound continues, washer is probably out of balance.	Stop washer and redistribute wash load.
Squealing sound or hot rubber odor.	Washer is overloaded.	Do not overload washer. Stop washer and reduce load.
Vibrating noise.	Washer is not resting firmly on floor.	Move washer so it rests firmly on floor. Adjust leveling legs. See INSTALLATION INSTRUCTIONS for details.
	Shipping bolt has not been removed during installation.	See INSTALLATION INSTRUCTIONS for removing shipping bolt.
	Wash load unevenly distributed in tub.	Stop washer and rearrange wash load.

## Avoid Service Checklist, continued

OCCURRENCE	POSSIBLE CAUSE	SOLUTION
<b>OPERATING</b>		
Washer does not start.	Washer lid is open.	Close washer lid. The washer will not fill with water, agitate or spin when the lid is open, and will only start to do so if the lid is closed.
	Electrical power cord may not be plugged in or connection may be loose.	Make sure plug fits tightly in wall outlet.
	House fuse blown, circuit breaker tripped, or a power outage has occurred.	Reset circuit breaker or replace fuse. Do not increase fuse capacity. If problem is a circuit overload, have it corrected by a qualified electrician. If problem is a power outage, call local electric company.
	Water supply faucets are not turned on.	Turn on water supply faucets.
	Cycle selector is not in correct position.	Move indicator clockwise slightly. Pull out knob.
	Motor is overheated. Washer motor will stop if it becomes overheated.	It will automatically restart after a cool down period of up to 30 minutes (if washer has not been manually turned off).
Washer won't spin.	Lid is not completely closed.	Close washer lid. The washer will not fill with water, agitate or spin when the lid is open, and will only start to do so if the lid is closed.
Residue left in drum.	Heavily soiled items.	Wipe drum with a nonabrasive household cleanser, then rinse. Shake or brush excess dirt and sand from items before washing
<b>WATER</b>		
Wash load too wet after spin.	Washer is overloaded.	Do not overload washer. See <b>Washing Procedures</b> .
	Load is out of balance.	Rearrange load to allow proper spinning.
	Drain hose is kinked.	Straighten drain hose.
Water does not enter washer or it enters slowly.	Washer lid is open.	Close washer lid. The washer will not fill with water, agitate or spin when the lid is open, and will only start to do so if the lid is closed.
	Water supply is not adequate in area.	Check another faucet in the house. Wait until water supply and pressure increase.
	Water supply faucets are not completely open.	Fully open hot and cold faucets.
	Water is being used elsewhere in the house.	Water pressure must be at least 30 psi (260 kPa). Avoid running water elsewhere while washer is filling.
	Water inlet hoses are kinked.	Straighten hoses.
Water level does not cover load.	Improper water level selection (for models with water level/load size control).	Select higher water level/load size.
	Washer is overloaded.	Do not overload washer. Dry load level should not be higher than top of agitator vanes.
Warm or hot water is not hot enough.	Hot water heater is set too low or is a distance from washer.	Measure hot water temperature at nearby faucet with candy or meat thermometer. Water temperature should be at least 120°F (50°C). Adjust water heater as necessary.
	Hot water is being used elsewhere in the house.	Avoid using hot water elsewhere before or during washer use. There may not be enough hot water available for proper cleaning. If problem persists, your hot water system may be unable to support more than 1 use at a time.
Water in washer does not drain or drains slowly.	Drain hose is kinked or clogged.	Clean and straighten the drain hose.
Water leaks.	Loose fill hose connection at faucet or washer.	Check and tighten hose connections. Install rubber sealing washers provided.
	House drain pipes are clogged.	Unclog drain pipes. Contact plumber if necessary.
Incorrect wash and rinse temperatures.	Hot and cold water hoses are connected to wrong supply faucets.	Connect hot water hose to hot water faucet and cold water hose to cold water faucet.
Water is entering washer but tub does not fill.	Drain hose standpipe is incorrect height.	Standpipe must be a minimum of 33" (83.82 cm) high to prevent siphoning. See <b>INSTALLATION INSTRUCTIONS</b> .
Water is present in tub after wash cycle is complete.	Lid lock malfunction.	Do not bypass lid lock. Call your authorized servicer.
The drain and spin cycles did not occur.	Lid lock malfunction.	Do not bypass lid lock. Call your authorized servicer.

# Major Appliance Warranty Information

Your appliance is covered by a one year limited warranty. For one year from your original date of purchase, Electrolux will pay all costs for repairing or replacing any parts of this appliance that prove to be defective in materials or workmanship when such appliance is installed, used and maintained in accordance with the provided instructions.

## Exclusions

This warranty does not cover the following:

1. Products with original serial numbers that have been removed, altered or cannot be readily determined.
2. Product that has been transferred from its original owner to another party or removed outside the USA or Canada.
3. Rust on the interior or exterior of the unit.
4. Products purchased "as-is" are not covered by this warranty.
5. Food loss due to any refrigerator or freezer failures.
6. Products used in a commercial setting.
7. Service calls which do not involve malfunction or defects in materials or workmanship, or for appliances not in ordinary household use or used other than in accordance with the provided instructions.
8. Service calls to correct the installation of your appliance or to instruct you how to use your appliance.
9. Expenses for making the appliance accessible for servicing, such as removal of trim, cupboards, shelves, etc., which are not a part of the appliance when it is shipped from the factory.
10. Service calls to repair or replace appliance light bulbs, air filters, water filters, other consumables, or knobs, handles, or other cosmetic parts.
11. Surcharges including, but not limited to, any after hour, weekend, or holiday service calls, tolls, ferry trip charges, or mileage expense for service calls to remote areas, including the state of Alaska.
12. Damages to the finish of appliance or home incurred during installation, including but not limited to floors, cabinets, walls, etc.
13. Damages caused by: services performed by unauthorized service companies; use of parts other than genuine Electrolux parts or parts obtained from persons other than authorized service companies; or external causes such as abuse, misuse, inadequate power supply, accidents, fires, or acts of God.

## DISCLAIMER OF IMPLIED WARRANTIES; LIMITATION OF REMEDIES

CUSTOMER'S SOLE AND EXCLUSIVE REMEDY UNDER THIS LIMITED WARRANTY SHALL BE PRODUCT REPAIR OR REPLACEMENT AS PROVIDED HEREIN. CLAIMS BASED ON IMPLIED WARRANTIES, INCLUDING WARRANTIES OF MERCHANTABILITY OR FITNESS FOR A PARTICULAR PURPOSE, ARE LIMITED TO ONE YEAR OR THE SHORTEST PERIOD ALLOWED BY LAW, BUT NOT LESS THAN ONE YEAR. ELECTROLUX SHALL NOT BE LIABLE FOR CONSEQUENTIAL OR INCIDENTAL DAMAGES SUCH AS PROPERTY DAMAGE AND INCIDENTAL EXPENSES RESULTING FROM ANY BREACH OF THIS WRITTEN LIMITED WARRANTY OR ANY IMPLIED WARRANTY. SOME STATES AND PROVINCES DO NOT ALLOW THE EXCLUSION OR LIMITATION OF INCIDENTAL OR CONSEQUENTIAL DAMAGES, OR LIMITATIONS ON THE DURATION OF IMPLIED WARRANTIES, SO THESE LIMITATIONS OR EXCLUSIONS MAY NOT APPLY TO YOU. THIS WRITTEN WARRANTY GIVES YOU SPECIFIC LEGAL RIGHTS. YOU MAY ALSO HAVE OTHER RIGHTS THAT VARY FROM STATE TO STATE.

## If You Need Service

Keep your receipt, delivery slip, or some other appropriate payment record to establish the warranty period should service be required. If service is performed, it is in your best interest to obtain and keep all receipts. Service under this warranty must be obtained by contacting Electrolux at the addresses or phone numbers below.

This warranty only applies in the USA and Canada. In the USA, your appliance is warranted by Electrolux Major Appliances North America, a division of Electrolux Home Products, Inc. In Canada, your appliance is warranted by Electrolux Canada Corp. Electrolux authorizes no person to change or add to any obligations under this warranty. Obligations for service and parts under this warranty must be performed by Electrolux or an authorized service company. Product features or specifications as described or illustrated are subject to change without notice.

USA  
1.800.944.9044  
Electrolux Major Appliances  
North America  
P.O. Box 212378  
Augusta, GA 30907



Canada  
1.800.265.8352  
Electrolux Canada Corp.  
5855 Terry Fox Way  
Mississauga, Ontario, Canada  
L5V 3E4

---

## **Notes**