

This Owner's Manual is provided and hosted by [Appliance Factory Parts](#).

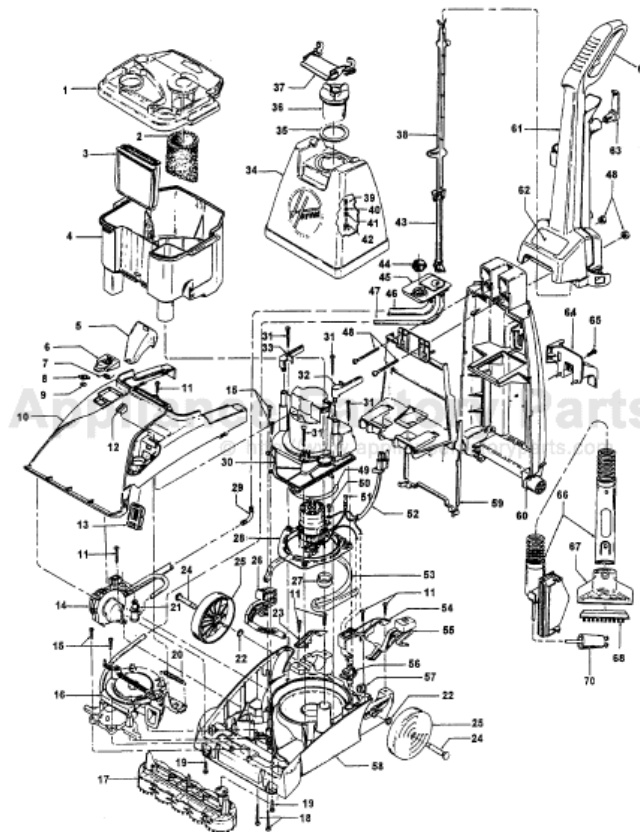

HOOVER F5858-900 Owner's Manual

[Shop genuine replacement parts for HOOVER
F5858-900](#)



[Find Your HOOVER Vacuum Cleaner Parts - Select From 1455 Models](#)

----- Manual continues below -----

Upright Extractor Models F5843-900, F5853-900, F5857-900, F5857-990 *, F5858-900, F5858-910, *F5858-920. F5860-900, F5860-990 **, F5861-900, F5861-990 *, F5863-900, F5863-990, F5886-900, F5900-900**

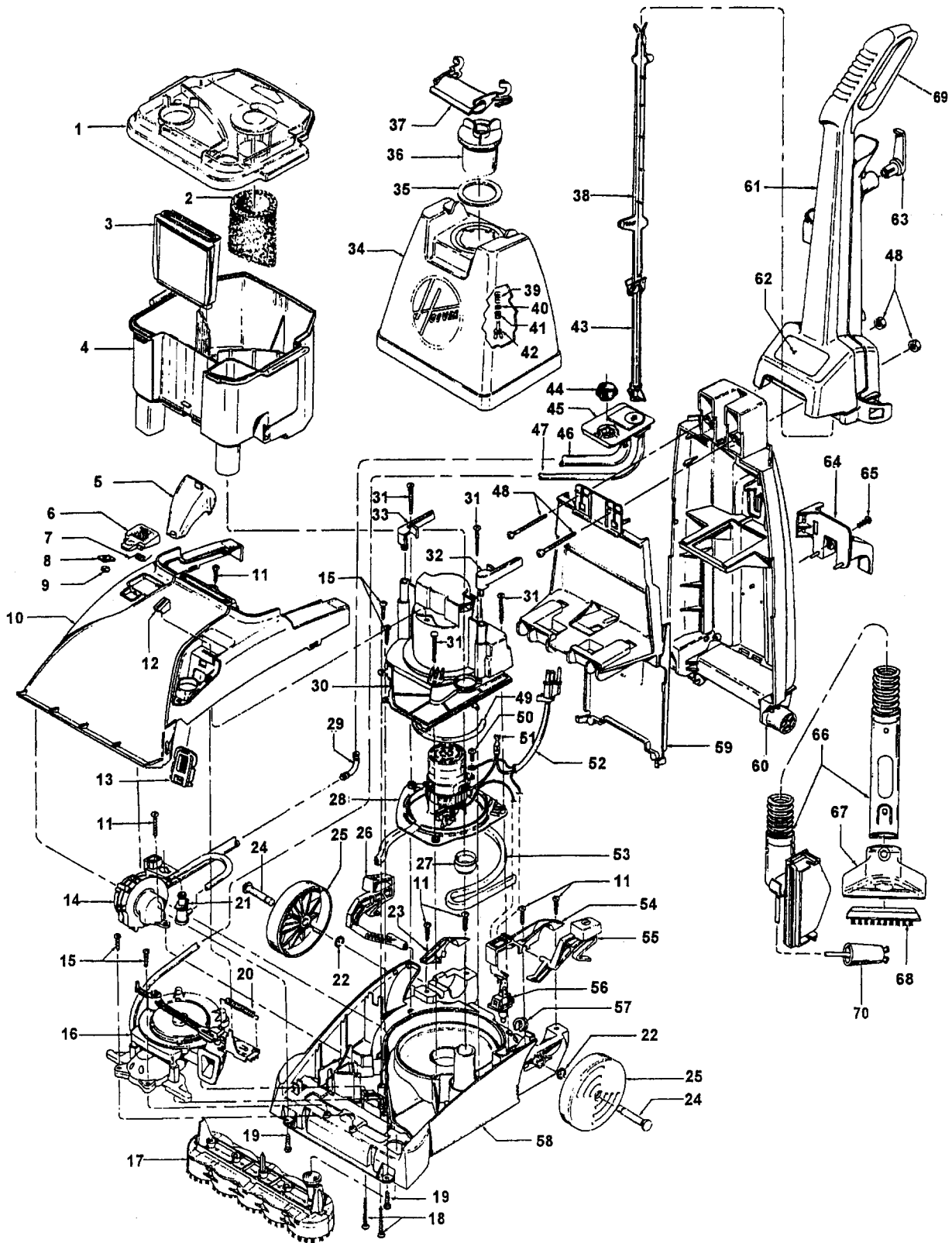

Upright Extractor Models F5843-900, F5853-900, F5857-900, F5857-990 *, F5858-900, F5858-910, *F5858-920, F5860-900, F5860-990 **, F5861-900, F5861-990 *, F5863-900, F5863-990, F5886-900, F5900-900**

Ref. No.	Part No.	Description	Ref. No.	Part No.	Description
1	42272111	Recovery Tank Lid Assem. (Incl. It. 2)	50	21447240	+ Screw - Self Tapping
2	43611041	Tank Filter	51	12227	Insulated Terminal
3	38661003	Duct - AFG	52	46583012	Cord - 33' - (use with GS Motor)
4	38777066	Recovery Tank (Inc. Items 1, 3)		46583044	Cord - 33' - (use with Hoover Motor)
5	39383106	Lens		46583056	Cord - 30' - (use with 12 Amp Motor)
6	Note: All doors include items 8 & 9		53	38781048	Motor Base Seal
	37257105	Door - F5857-900, F5857-990	54	36131086	Trunnion Cover - LH
	37257106	Door - F5853-900, F5860-900	55	38434025	Switch Actuator Lever
	37257205	Door - F5861-900, F5861-990	56	28218048	Push ON/OFF Switch
	37257208	Door - F5863-900, F5863-990	57	36172016	Cord Retainer
	37257209	Door - F5858-900 before 11/02	58	37272088	Main Body
	37257279	Door - F5858-910, F5900-900		37272090	Main Body - F5843-900, F5858-910, F5886-900
	37257102	Door - F5843-900, F5858-900 after 11/02		42274006	Main Body - F5900-900 (Inc. Exh. Duct)
	37257297	Door - F5886-900	59	37276001	Handle Cover
7	38351017	Spring -Access Door	60	39466033	Lower Handle
8	38783021	Seal	61	48663181	Upper Handle Assem. (Incl. It. 38, 63, 69)
9	21362006	* Speed Nut	62	N/A	Nameplate - Upper Handle
10	Note: All Hoods include items 6, 7, 8, and 9		63	39442039	Cord Wrap
	37271072	Hood - AFC - F5861-900, F5861-990	64	41426030	Tool Rack (Inc. item 65)
	37271036	Hood - ABY - F5853-900, F5860-900/990	65	21447003	* Screw Self-Tapping
	37271088	Hood - ABM- F5857-900, F5857-990	66	40309007	Hose Assembly (Incl. It. 64, 67, 68, 70)
	37271041	+ Hood - ACF - F5863-900, F5863-990	67	38613040	Nozzle Body (w/ release tab)
	37271065	Hood - Slate Gray-F5858-900 before 11/02	68	48445003	Brush Back Assem.
	37271072	Hood - AFC - F5858-910, F5900-900	69	39458005	Handle Lever Guard
	37271100	Hood - ABW - F5843-900, F5858-900 after 11-02	70	43513010	Connector Coupler Sleeve Assem.
	37271096	Hood - AG - F5886-900	Items Not Illustrated		
11	21447020	* Screw - Self Tapping (5)		48417003	Bare Floor Cleaning Tool - All models except F5886-900
12	38421093	Indicator Knob		39514001	Nozzle Clean Out Tool - All models except F5858-910
13	43613009	Screen Assembly		43412003	Sprayer - F5857-900, F5860-990
14	43582003	Pump Assembly (Incl. It. 21)		48439002	Turbine Nozzle - F5886-900
15	21447217	* Screw - Self Tapping (5)		38769028	Exhaust Duct - F5900-900 (main body)
16	43191001	Turbine and Gear Assem. (Incl. It. 20)		51638054	Handle Release Label - F5858-900, F5858-910
17	48437022	Brush Block Assem.		51638055	* Handle Release Label
18	21479438	* Screw (2)		51865024	* On / Off Label
19	21447072	* Screw - Self Tapping (2)		51639117	Door Label - Uph. & Stair Clng. Conn. - F5843-900, F5858-900, F5858-910
20	38333009	Spring		51639124	* Door Label - Uph. & Stair Clng Conn.
21	43523004	Quick Disconnect Assembly		51855032	+ Agitator Speed Label
22	160017	* Retaining Ring (2)		38719027	Float Retainer - Recovery Tank Lid
23	36131085	Trunnion Cover - RH		43538001	Float - Recovery Tank Lid
24	32434007	Rear Axle (2)		38784070	Seal - Float Retainer
25	38522076	Rear Wheel (2)	Accessories		
26	38458042	Handle Release Lever		57333016	Carpet Cleaning Solution - 16 Oz.
27	38784063	Standpipe Seal		40302016	Pre-Cleaner Solution - 16 Oz.
28	40309008	Motor Kit - Inc. Hoover Motor, Motor Cover and lead wire. Replaces GS Motor's		40303032	Bare Floor Cleaner - 32 Oz.
	43576202	Motor - Hoover Motor		40301064	Carpet Cleaning Solution - 64 Oz.
	41311016	Motor Brush (Hoover Motor ONLY)	Packaging Material		
	27212051	+ Motor - 12 Amp - Ametek - F5858-910		56518090	Owner Manual
	43576197	Motor - 12 Amp - Hoover - F5843-900, F5886-900, F5900-900		56518119	Owner Manual - F5843-900, F5858-900, F5858-910, F5900-900
29	33241001	Elbow Connector		58176023	Carton - Common
30	40309006	Motor Cover		58313006	Handle Protector
31	21447232	* Screw - Self Tapping (4)		58315006	Rear Support
32	36151029	Tank Release Latch - LH		58332024	+ Bottom Rear Support
33	36151019	Tank Release Latch - RH		58364017	Mid Support
34	42272134	Solution Tank- Inc. It. 35,36,39,40,41,42		58461019	Front / Rear Support
35	38784062	Gasket	* Model F5857-990 , F5861-990 are identical to models F5857-900, F5861-900 respectively except for addition of one 64 Oz. bottle of Carpet/Upholstry Cleaner.		
36	42272002	Solution Tank Cap	** Model F5860-990 is identical to model U5860-990 except for the addition of one 64 Oz. bottle of Carpet /Uph Cleaner, one 16 Oz. Pre Cleaner with sprayer, and one Car Cleaning Tool (38613028)		
37	39457016	Solution Tank Handle	***Model F5858-920 is identical to the model F5858-900 except for the addition of one 32 oz. bottle of Pre Cleaner w/ sprayer.		
38	38458031	Control Rod - Upper			
39	38312014	Spring - Solution Tank			
40	21312518	+* Washer -Brass - used on early models only			
41	38784061	Valve Seal			
42	38717009	Valve Stem - Solution Tank			
43	38458033	Control Rod - Lower			
44	38784060	Solution Tank Seal			
45	43516008	Reservoir Assem. (Incl. It. 44)			
46, 47	40309002	Tubing Assem. (Incl. It. 29,46,47)			
48	40201149	Handle Hardware			
49	34113004	Motor Seal			