

This Owner's Manual is provided and hosted by [Appliance Factory Parts](#).

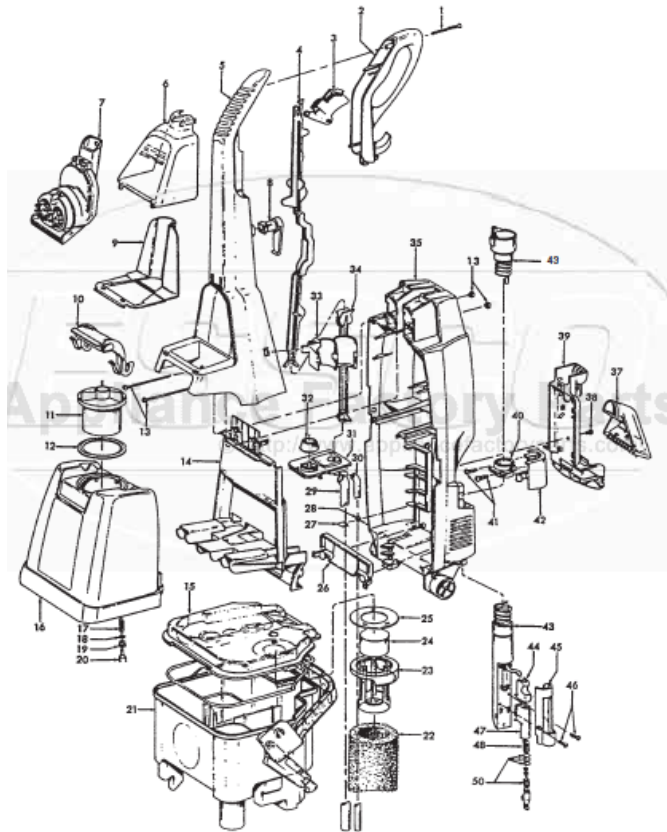

HOOVER F5883-900 Owner's Manual

[Shop genuine replacement parts for HOOVER
F5883-900](#)



[Find Your HOOVER Vacuum Cleaner Parts - Select From 1456 Models](#)

----- Manual continues below part list -----

Available Replacement Parts for HOOVER F5883-900

HR-2400	Brush block Aftermarket
H-38784062	Gasket .
H-39383106	Lens.
H-38613040	NOZZLE BODY, WITH RELEASE TAB
H-38762010	FILTER, EXTRACTOR FOAM

HOOVER Original

STEAM VAC

Models F5837-900, F5839-900, F5865-900, F5867-900, F5868-900, F5869-900, F5869-990, F5881-900, F5883-900, F5884-900

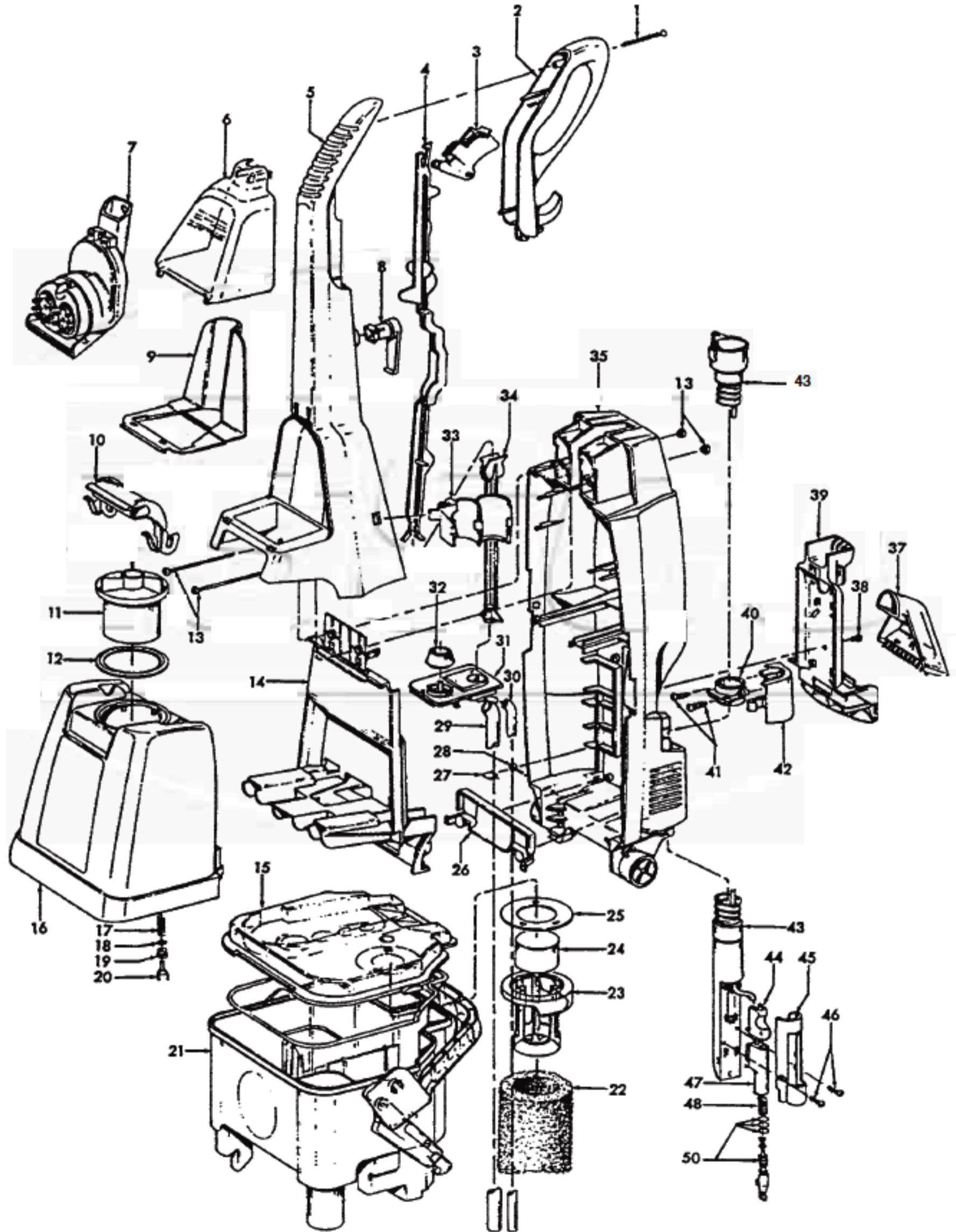

Original **HOOVER**

STEAM VAC

Models F5837-900, F5839-900, F5865-900, F5867-900, F5868-900,
F5869-900, F5869-990, F5881-900, F5883-900, F5884-900

KEY	PART NO.	DESCRIPTION	KEY	PART NO.	DESCRIPTION
1	H-21447248	Screw	32	H-38784060	Solution Tank Seal
2	H-39458006	Handle Lever Guard	33	H-36172005	Hose/Nozzle Holder
3	H-38434028	Trigger	34	H-38458033	Control Rod Lower
4	H-38458037	Upper Control Rod	35	H-39466037	Lower Handle
5	H-39466004	Upper Handle - F5881-900, F5883-900, F5884-900 (Incl. Items 1, 2, 3, 4, 8)	37	H-38613033	Nozzle Body (without Release Tab)
5	H-39466036	Upper Handle - F5837-900, F5839-900, F5865-900, F5868-900, F5869-900 (Incl. Items 1, 2, 3, 4, 8)	37	H-38613040	Nozzle Body (with Release Tab)
6	H-37276007	Tool Holder - F5881-900, F5883-900, F5884-900	38	H-21447041	Screw
7	H-48439001	Turbine Nozzle - F5881-900, F5883-900, F5884-900 (without Release Tab)	39	H-36433131	Tool Rack - Lower
7	H-48439002	Turbine Nozzle - F5881-900, F5883-900, F5884-900 (with Release Tab)	40	H-36171032	Hose Clamp
8	H-39442041	Cord Wrap	41	H-21447228	Screw (2)
9	H-36433126	Tool Holder - F5881-900, F5883-900, F5884-900	42	H-36131097	Hose Cover
10	H-39457016	Solution Tank Handle	43	H-43436002	Hose Ass'y (Incl. Item. 37 & 43 thru 50) (without Release Tab)
11	H-42272002	Solution Tank Cap (Incl. Item 12)	43	H-43436004	Hose Ass'y (Incl. Item. 37 & 43 thru 50) (with Release Tab)
12	H-38784062	Gasket	44	H-38433074	Trigger
13	H-40201154	Handle Hardware Assembly	45	H-37276006	Wand Cover
14	H-37276002	Handle Cover	46	H-21447239	Screw
15	H-42272120	Lid Ass'y (Incl. Items 22, 23, 24, 25)	47	H-43513008	Wand/Valve Assembly
16	H-42272105	Solution Tank Ass'y Without Handle (Incl. Items 11, 12, 17, 18, 19, 20)	48	H-38312019	Spring
17	H-38312014	Spring	50	H-43412004	Nozzle Valve Assembly
18	NLA	Washer - Brass	ACCESSORIES		
19	H-38784061	Valve Seal	H-48417002	Bare Floor Tool - All Models	
20	H-38717009	Valve Stem	H-57333016	Carpet Solution - 16 oz.- All Models	
21	H-38777037	Recovery Tank - (Incl. Item 15)	H-40303032	Bare Floor Solution - 32 oz.	
22	H-38762010	Tank Filter	H-40302016	Pre Cleaner Solution - 16 oz. F5839-900, F5867-900, F5868-900, F5869-900, F5881-900, F5883-900	
23	H-38719027	Float Retainer	* The F5869-990 is identical to the model F5869-900 except for the addition of one 64 oz. bottle of Carpet/Uph. cleaner.		
24	H-25661016	Float			
25	H-38784070	Seal			
26	H-37276010	Solution Tube Cover			
27	H-21378162	Retaining Clip			
28	H-21447244	Screw - Special			
29	H-40309002	Hose Kit, 4 Hoses With One Connector			
30	H-40309002	Hose Kit, 4 Hoses With One Connector			
31	H-43516008	Reservoir Ass'y (Incl. Item 32)			

NLA = No Longer Available

HOOVER Original

STEAM VAC

Models F5837-900, F5839-900, F5865-900, F5867-900, F5868-900, F5869-900, F5869-990, F5881-900, F5883-900, F5884-900

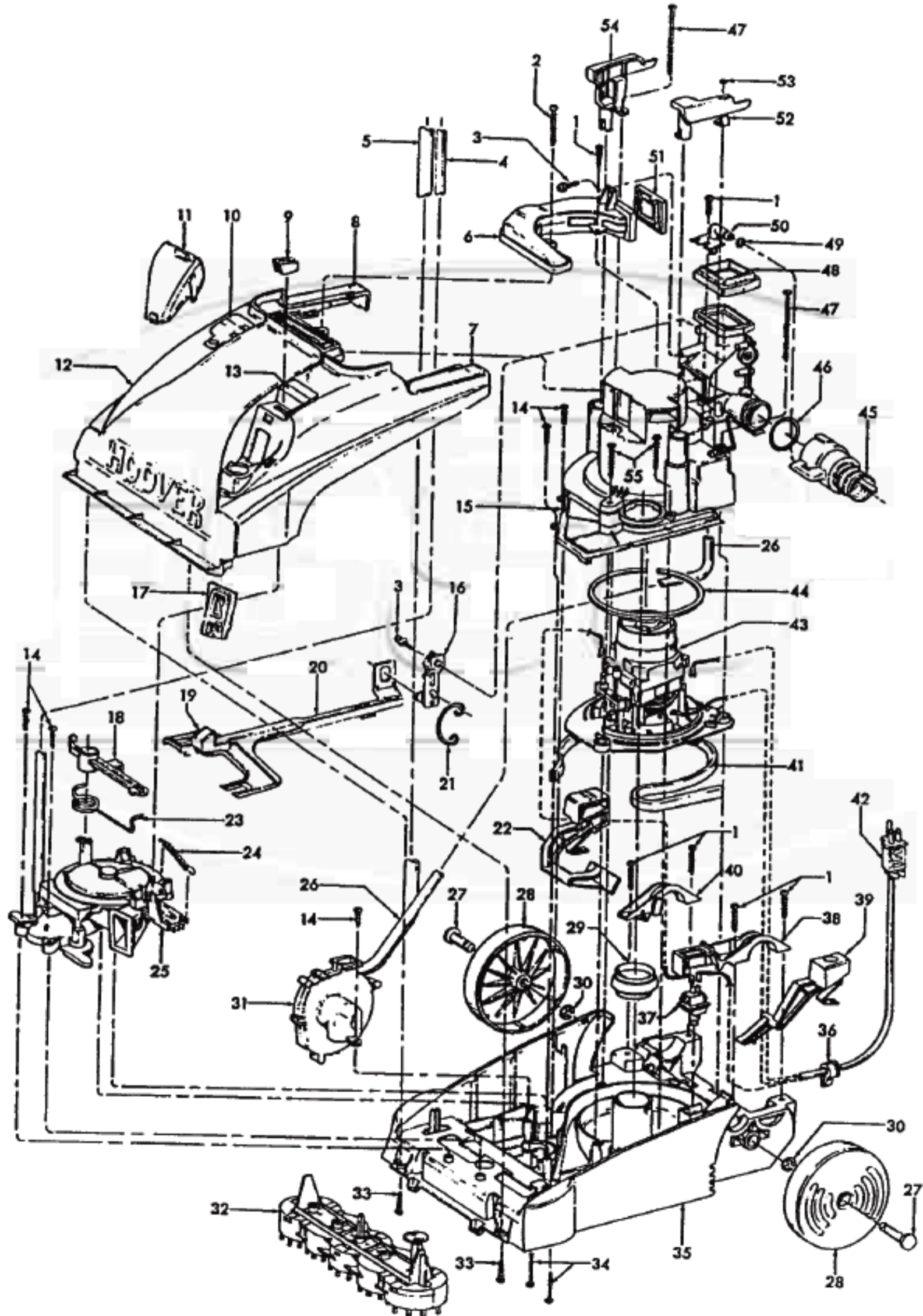

Original **HOOVER**

STEAM VAC

Models F5837-900, F5839-900, F5865-900, F5867-900, F5868-900,
F5869-900, F5869-990*, F5881-900, F5883-900, F5884-900

KEY	PART NO.	DESCRIPTION
1	H-21447248	Screw
1	H-21447003	Screw
2	H-21447247	Screw
3	H-23149002	Screw
4	H-40309002	Tubing Assembly
5	H-40309002	Tubing Assembly
6	H-43466071	Duct
7	H-51865024	On Off Label
8	H-51638055	Handle Release Label
9	H-38421093	Indicator Knob
10	H-51438006	Nameplate - Tool Mode
11	H-39383106	Lens
12	H-37271045	Hood - (Incl. Items 11, 17) - F5837-900
12	H-37271046	Hood - (Incl. Items 11, 17) - F5839-900
12	H-37271044	Hood - (Incl. Items 11, 17) - F5865-900
12	H-37271073	Hood - (Incl. Items 11, 17) - F5867-900
12	H-37271051	Hood - (Incl. Items 11, 17) - F5868-900
12	H-37271052	Hood - (Incl. Items 11, 17) - F5869-900
12	H-37271049	Hood - (Incl. Items 11, 17) - F5881-900
12	H-37271043	Hood - (Incl. Items 11, 17) - F5883-900
12	H-37271048	Hood - (Incl. Items 11, 17) - F5884-900
13	H-51855028	Agitator Speed Label
14	H-21447217	Screw
15	H-42191005	Motor Cover/Valve Assembly F5837-900, F5839-900
15	H-42191007	Motor Cover/Valve Assembly F5865-900, F5867-900, F5868-900 F5869-900, F5881-900, F5883-900 F5884-900
16	H-36439001	Valve Crank Arm
17	H-43613009	Filter Screen For Turbine
18	N/A	See Key 25
19	H-51611008	Indicator Label - Green
20	H-38458050	Turbine Actuator Arm F5837-900, F5839-900
20	H-38458024	Turbine Actuator Arm - F5865-900, F5867-900, F5868-900, F5869-900, F5881-900, F5883-900, F5884-900
21	H-36132003	Over Center Spring
22	H-38458042	Handle Release Lever
23	H-38356013	Spring
24	H-38333009	Spring
25	H-43191003	Turbine Assembly - (Incl. Items 18, 23, 24)
26	H-40309003	Tubing Assembly

KEY	PART NO.	DESCRIPTION
27	H-32434007	Rear Axle
28	H-38522076	Rear Wheel
29	H-38784063	Standpipe Seal
30	H-160017	Lock Ring
31	H-43582005	Pump Assembly
32	H-48437022	Brush Block Except F5837-900 & F5839-900
	H-48447002	Brush Strip F5837-900 & F5839-900
33	H-21447072	Screw
34	H-21479438	Screw
35	H-37272095	Main Body - F5837-900, F5839-900
35	H-37272088	Main Body - F5865-900, F5867-900, F5868-900, F5869-900, F5881-900, F5883-900, F5884-900
36	H-36172016	Cord Retainer
37	H-28218048	Switch
38	H-36131086	Trunion Cover - L.H.
39	H-38434025	Switch Actuator Lever
40	H-36131085	Trunion Cover - R.H.
41	H-38781048	Motor Base Seal
42	H-46583044	Cord (Use with Hoover Motor)
42	H-46583011	Cord (Use with GS Motor)
43	H-43576160	Motor - F5837-900, F5839-900
43	H-43576163	Motor - F5865-900, F5867-900, F5868-900, F5869-900, F5881-900, F5883-900
44	H-34113004	Motor Seal
45	H-43436002	Hose Assembly (w/Turbo Tool)
45	H-43436004	Hose Assembly
46	H-25156518	"O" Ring
47	H-21447246	Screw
48	H-38783023	Valve Tank Seal
49	H-25156517	"O" Ring
50	H-38719039	Solution Hose Coupler
51	H-38783024	Valve Duct Seal
52	H-36151021	Latch Lock - LH
53	H-21364107	Speed Nut
54	H-36151020	Latch Lock - RH
55	H-21447232	Screw

* The F5869-990 is identical to the model F5869-900 except for the addition of one 64 oz. bottle of Carpet/Upholstery cleaner.