

This Owner's Manual is provided and hosted by [Appliance Factory Parts](#).

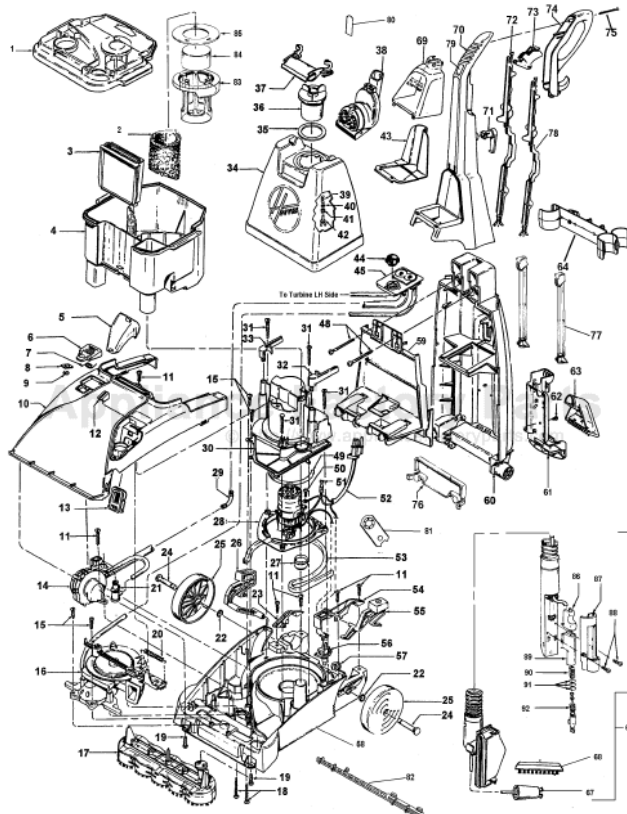

HOOVER F5905-900 Owner's Manual

[Shop genuine replacement parts for HOOVER
F5905-900](#)



[Find Your HOOVER Vacuum Cleaner Parts - Select From 1456 Models](#)

----- Manual continues below part list -----

Available Replacement Parts for HOOVER F5905-900

HR-2400	Brush block Aftermarket
H-38784062	Gasket .
H-38777008	Recovery Tank without lid .
H-39383106	Lens.
H-38613040	NOZZLE BODY, WITH RELEASE TAB

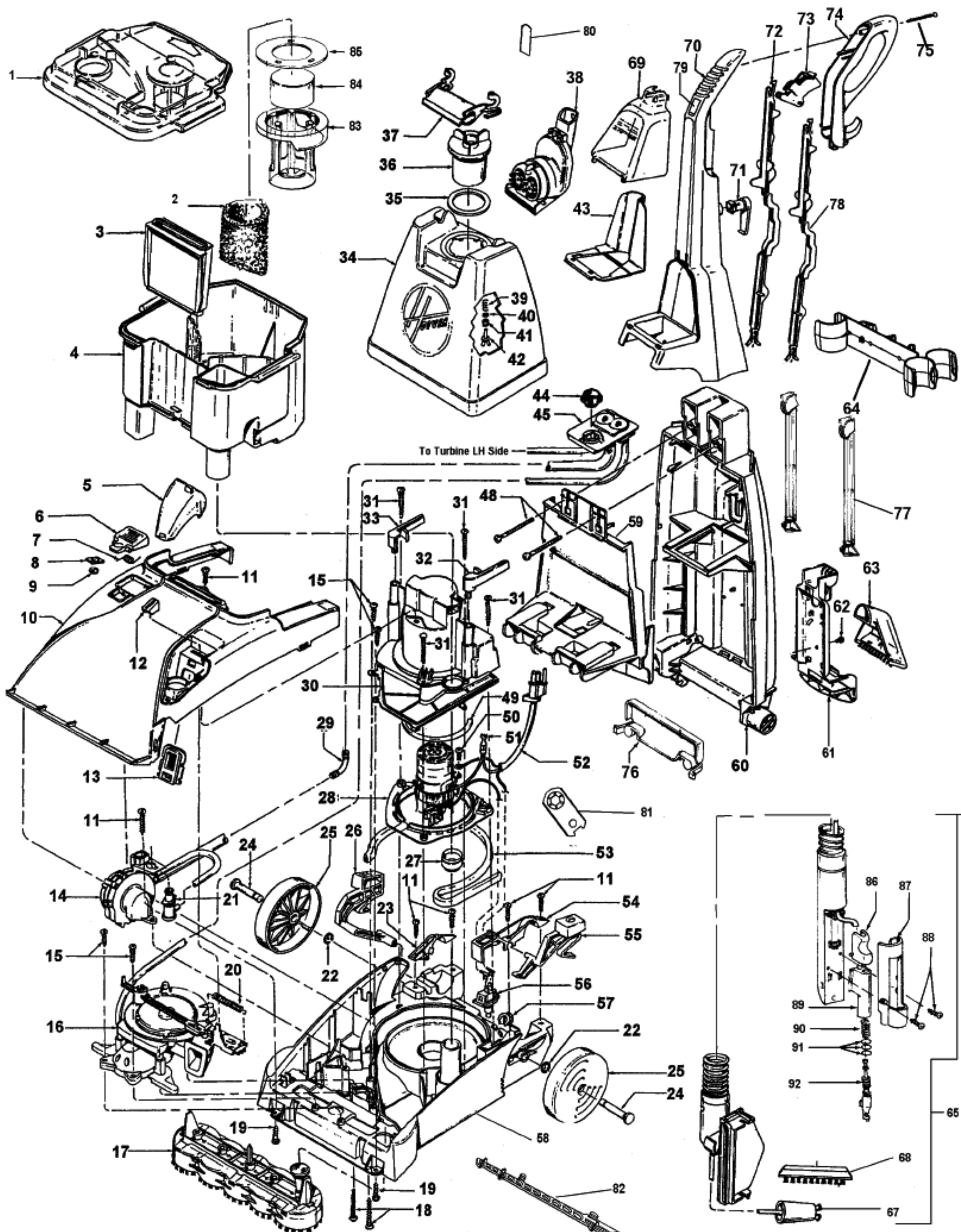

1	H-42272111	Recovery Tank Lid Assembly (Incl. It. 2)
2	H-43611041	Tank Filter
3	H-38661003	Duct - AFG
4	H-38777081	Recovery Tank (Inc. items 1, 2, 3)
5	H-39383106	Lens
6		Note: All Doors include items 8 & 9
	H-37257288	Door - NAA - F5910-900
	H-37257297	Door - AG - F5903-900, F5904-900, F5912-900
	H-37257307	Door - AFT - F5914-900
	H-37257308	Door - ADM - F5905-900
7	H-38351017	Spring -Access Door
8	H-38783021	Seal
9	H-21362006 *	Speed Nut
10		Note: All Hoods include items 6, 7, 8, 9
	H-37271108	Hood - AFM - F5903-900
	H-37271114	Hood - ABW - F5904-900
	H-37271109	Hood - NAA - F5910-900
	H-37271096	Hood - AG - F5912-900
	H-37271110	Hood - AFT - F5914-900
	H-37271111	Hood - ADM - F5905-900
11	H-21447020 *	Screw - Self Tapping (5)
12	H-38421093	Indicator Knob
13	H-43613009	Screen Assembly
14	H-43582003	Pump Assembly (Incl. It. 21)
15	H-21447217 *	Screw - Self Tapping (5)
16	H-43191008	Turbine and Gear Assembly (Incl. It. 20)
17	H-48437022	Brush Block Assem.
18	H-21479438 *	Screw (2)
19	H-21447072 *	Screw - Self Tapping (2)
20	H-38333009	Spring
21	H-43523004	Quick Disconnect Assembly
22	H-160017-- *	Retaining Ring (2)
23	H-36131085	Trunnion Cover - RH
24	H-32434007	Rear Axle (2)
25	H-38522076	Rear Wheel (2)
26	H-38458042	Handle Release Lever
27	H-38784063	Standpipe Seal
28	H-43576197	Motor - 12 Amp - Hoover
29	H-33241001	Elbow Connector
30	H-40309006	Motor Cover
31	H-21447232 *	Screw - Self Tapping (4)
32	H-36151029	Tank Release Latch - LH
33	H-36151019	Tank Release Latch - RH
34	H-42272134	Solution Tank- (Inc. It. 35,36,37,39,41,42)
35	H-38784062	Gasket
36	H-42272002	Solution Tank Cap
37	H-39457016	Solution Tank Handle
38	H-48439002	Turbine Nozzle - F5905-900, F5910-900 (See Note)
39	H-38312014	Spring - Solution Tank
40	not applicable	
		Washer -Brass
41	H-38784061	Valve Seal
42	H-38717009	Valve Stem - Solution Tank
43	H-36433127	Tool Holder
44	H-38784060	Solution Tank Seal
45	H-43526016	Reservoir Assem. (Incl. It. 44)
46, 47	H-40309002	Tubing Assembly (Incl. Items 29,46,47)
48	H-40201154	Handle Hardware
49	H-34113004	Motor Seal
50	not applicble	Screw - Self Tapping
51	H-12227	Insulated Terminal
52	H-46583056	Cord - 30'
53	H-38781048	Motor Base Seal
54	H-36131086	Trunnion Cover - LH
55	H-38434025	Switch Actuator Lever
56	H-28218048	Switch
57	H-36172016	Cord Retainer
58	H-42274006	Main Body (Inc. Exhaust Duct Cover)
59	H-37276002	Handle Cover
60	H-39466082	Lower Handle (Inc. items 45, 76, 77)
61	H-36433171	Lower Tool Holder
62	H-21447041 *	Screw
63	H-38613040	Nozzle Body
64	H-36433172	Hose Holder - Upper
65	H-43491039	Hose Assembly - ABU (Includes items 61, 62, 63)
		Hose Assembly - Clear - F5905-900 (includes items 61, 62, 63)

66	H-38613040	Nozzle Body
67	H-43513010	Connector Coupler Sleeve Assem
68	H-48445003	Brush Back Assembly
69	H-37276014	Tool Cover - F5903-900, F5910-900
	H-37276011	Tool Cover - F5904-900, F5912-900
70	H-39466039	Upper Handle (Inc. items 71,72,73,74,75,
71	H-39442044	Cord Wrap
72	H-38458056	Upper Control Rod
73	H-38434029	Control Lever
74	H-39458007	Handle Lever Guard
75	H-21447255	Screw
76	H-37276010	Solution Tube Cover
77	H-38458033	Control Rod - Lower
78	H-38458055	Control Rod Upper - Rear
79	H-38433079	Solution Button
80	H-51639165	Nameplate - Clean Surge
81	H-36132004	Tubing Retainer
82	H-38769028	Exhaust Duct Cover - Main Body
83	H-38719027	Float Retainer
84	H-43538001	Float
85	H-38784070	Seal - Float Retainer
86	H-38433074	Trigger
87	H-37276006	Wand Cover
88	H-21447239	* Screw
89	H-43513011	Wand / Valve Assembly
90	H-38312019	Spring
91	N/A	O-Ring (included with item 92)
92	H-43412007	Nozzle Valve Assembly

Items Not Illustrated

Labels

H-51638055	*	Handle Release Label
H-51865024	*	On / Off Label
H-51639124	*	Door Label - Uph. & Stair Clng Conn.
H-51855030		Agitator Speed Label

Lead Wires

H-49811079	Lead Wire - White
H-49811080	Lead Wire - Purple
H-49811081	Lead Wire - Red

Accessories

H-40301032	Carpet Cleaning Solution - 32 Oz.
H-40302016	Pre Cleaner - 16 Oz.
H-43412003	Sprayer
H-57333016	Carpet Cleaning Solution - 16 Oz.

Packaging Material

H-56518158	Owner Manual - F5903-900, F5905-900, F5910-900, F5914-900
H-56518159	Owner Manual - F5904-900, F5912-900
H-58176192	Carton - F5910-900
H-58176023	Carton - Common - F5903-900, F5904-900, F5905-900, F5914-900
H-58176189	Carton - F5912-900

Note: The 48439002 is mounted in the upper handle on the F5903-900 & F5910-900 and is packed in the carton of the F5904-900 & F5912-900.