

This Owner's Manual is provided and hosted by [Appliance Factory Parts](http://ApplianceFactoryParts.com).

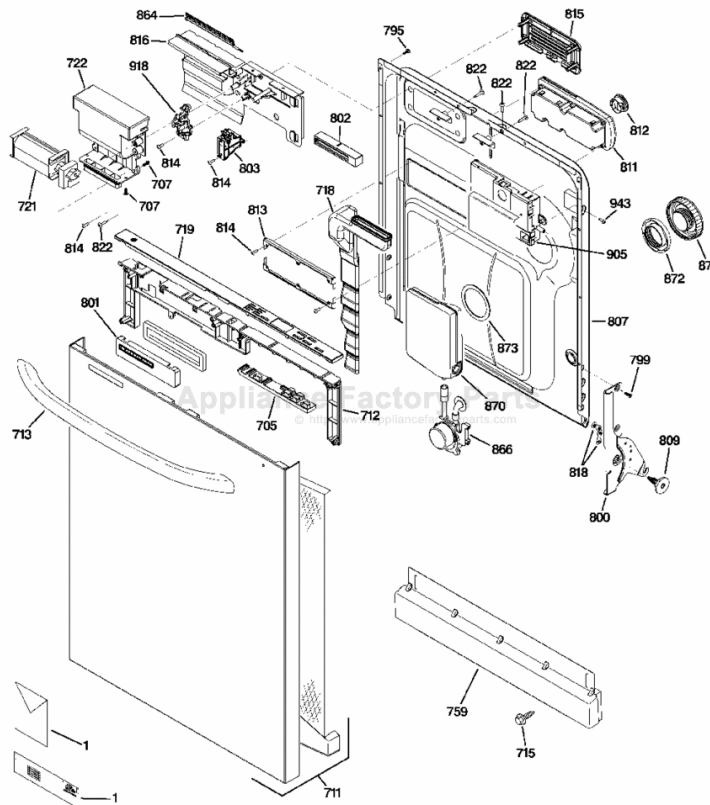

GE GDWT768V00SS Owner's Manual

[Shop genuine replacement parts for GE
GDWT768V00SS](#)



[Find Your GE Dishwasher Parts - Select From 6722 Models](#)

----- Manual continues below -----



Dishwashers

Safety Instructions 2-5

Operating Instructions

Care and Cleaning 17
Control Panel and Settings 6-9
Display Lights 6
Loading Place Settings 16
Loading the Racks 14-16
Recommended Dishwasher
Products 9
Using the Dishwasher 10-13

Troubleshooting Tips 18-20

Consumer Support

Consumer Support 24
Warranty 23

Owner's Manual

*Stainless Steel
Tub Dishwashers*

*Write the model and serial
numbers here:*

Model # _____

Serial # _____

You can find them on the tub wall
just inside the door.

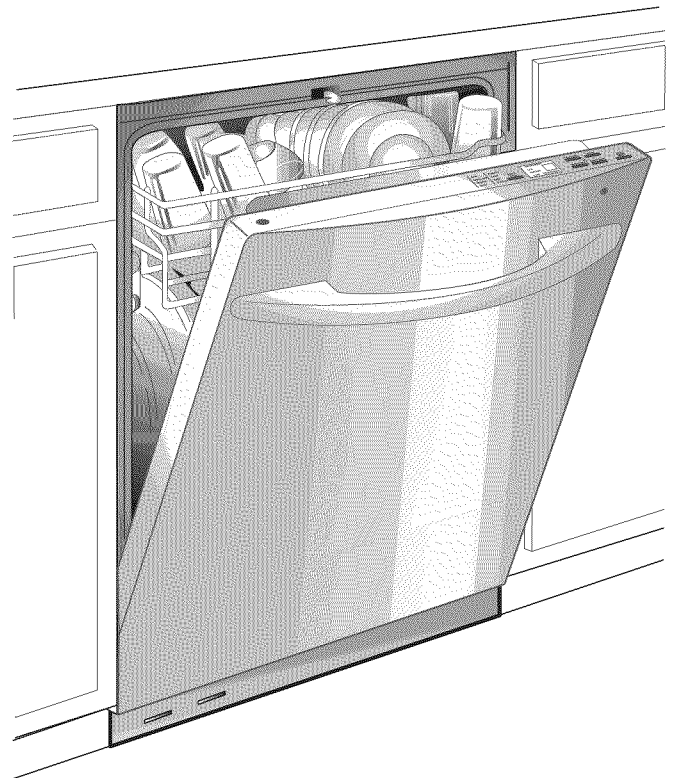

IMPORTANT SAFETY INFORMATION

READ ALL INSTRUCTIONS BEFORE USING— SAVE THESE INSTRUCTIONS

⚠ WARNING!

For your safety, the information in this manual must be followed to minimize the risk of fire, explosion, electric shock, and to prevent property damage, personal injury, or death.

⚠ ¡ADVERTENCIA!

Para su seguridad, siga las instrucciones de este manual a fin de minimizar riesgos de incendio, explosión, descargas eléctricas, y para evitar daños en su propiedad, lesiones personales o la muerte.



⚠ WARNING! WATER HEATER SAFETY

Under certain conditions, hydrogen gas may be produced in a water heater that has not been used for two or more weeks. **HYDROGEN GAS IS EXPLOSIVE.**

If the hot water has not been used for two or more weeks, prevent the possibility of damage or injury by turning on all hot water faucets and allow them to run for several minutes. Do this before using any electrical appliance connected to the hot water system. This simple procedure will allow any built-up hydrogen gas to escape. Since the gas is flammable, do not smoke, use an open flame, or use the appliance during this process.



⚠ ¡ADVERTENCIA! SEGURIDAD DEL CALENTADOR DE AGUA

Bajo ciertas condiciones, se podrá producir gas de hidrógeno en un calentador de agua que no fue usado por dos semanas o más. **EL GAS DE HIDRÓGENO ES EXPLOSIVO.**

Si el agua caliente no se usó por dos semanas o más, evite la posibilidad de que ocurran daños o lesiones abriendo todos los grifos de agua caliente y dejando que corra agua por varios minutos. Haga esto antes de usar cualquier artefacto eléctrico conectado al sistema de agua caliente. Este procedimiento simple permitirá la salida de cualquier acumulación de gas de hidrógeno. Debido a que el gas es inflamable, no fume, no use una llama abierta ni use el electrodoméstico durante este proceso.



PROPER INSTALLATION AND MAINTENANCE

This dishwasher must be properly installed and located in accordance with the Installation Instructions before it is used. If you did not receive an Installation Instructions sheet with your dishwasher, you can receive one by visiting our website at GEAppliances.com. In Canada, visit www.GEAppliances.ca.

- Connect the dishwasher/appliance to a grounded metal, permanent wiring system; or run an equipment-grounding conductor with the circuit conductors and connect to the equipment-grounding terminal or lead of the appliance.
 - Improper connection of the equipment-grounding conductor can result in a risk of electric shock. Check with a qualified electrician or service representative if you are in doubt whether the appliance is properly grounded.
 - Dispose of discarded appliances and shipping or packing material properly.
 - Do not attempt to repair or replace any part of your dishwasher unless it is specifically recommended in this manual. All other servicing should be referred to a qualified technician.
 - To minimize the possibility of electric shock, disconnect this appliance from the power supply before attempting any maintenance.
- NOTE:** Turning the dishwasher off does not disconnect the appliance from the power supply. We recommend having a qualified technician service your appliance.

IMPORTANT SAFETY INFORMATION

READ ALL INSTRUCTIONS BEFORE USING—

SAVE THESE INSTRUCTIONS



CAUTION: To prevent minor injury and property damage

- Contents washed in Anti-bacterial mode, if available, may be hot to the touch. Use care before handling.
- Using a detergent that is not specifically designed for dishwashers will cause the dishwasher to fill with suds.
- If your dishwasher is connected to a wall switch, ensure that the switch is on prior to use.
- On dishwashers with electronic controls, if you choose to turn the wall switch off between wash cycles, allow 5-10 seconds after turning the switch on before touching **START/RESET** to allow the control to initialize.



- Non-Dishware Items: Do not wash items such as electronic air cleaner filters, furnace filters and paint brushes in your dishwasher. Damage to the dishwasher and discoloration or staining of the dishwasher may result.
- Close supervision is necessary if this appliance is used by or near children.
- Load light, plastic items so they do not become dislodged and drop to the bottom of the dishwasher—they might come into contact with the heating element and be damaged.

PRECAUCIÓN: A fin de evitar lesiones menores y daños sobre la propiedad

- Los contenidos lavados en el modo **SANI WASH/SANITIZE (Lavado Desinfectante/ Desinfección)**, si este producto está disponible, podrán estar calientes al tacto. Tenga cuidado antes de tomar los mismos con las manos.
- El uso de un detergente que no esté diseñado específicamente para lavavajillas hará que este último se llene de agua con jabón.
- Si el lavavajillas está conectado a un tomacorriente, asegúrese de que el interruptor esté encendido antes del uso.
- Si el lavavajillas tiene controles electrónicos, en caso de decidir apagar el interruptor entre ciclos de lavado, espere entre 5 y 10 segundos luego de encender el interruptor antes de presionar **START/RESET (Iniciar/ Reiniciar)** para permitir que el control se inicie..



- Ítems que no sean Utensilios: No lave artículos tales como filtros electrónicos de limpieza con aire, filtros de horno y brochas de pintura en su lavavajillas. Se podrán producir daños, descoloración o manchas sobre el lavavajillas.
- Se deberá estar especialmente atento si el electrodoméstico es usado por niños o si se encuentra cerca de los mismos.
- Cargue artículos de plástico livianos, de modo que no sean desplazados ni caigan al fondo del lavavajillas – es posible que entren en contacto con el elemento calentador y sean dañados.

ELECTRICAL REQUIREMENTS

- This appliance must be supplied with 120V, 60 Hz, and connected to an individual, properly grounded branch circuit, protected by a 15 or 20 amp circuit breaker or time-delay fuse.
- If the electric supply provided does not meet the above specifications, it is recommended that a licensed electrician install an approved outlet.

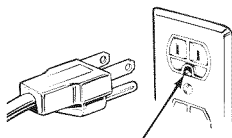

Ensure proper ground exist before use (portable models only).

- Your dishwasher circuit should not be used for any other appliance while the dishwasher is in operation as the dishwasher requires the full capacity of the circuit.
- If the wall receptacle you plug the dishwasher's power cord into is controlled by a switch, turn on the switch.

IMPORTANT SAFETY INFORMATION

READ ALL INSTRUCTIONS BEFORE USING—

SAVE THESE INSTRUCTIONS

⚠️ WARNING! RISK OF CHILD ENTRAPMENT

PROPER DISPOSAL OF THE DISHWASHER

Junked or abandoned dishwashers are dangerous...even if they will sit for "just a few days." If you are getting rid of your old dishwasher, please follow the instructions below to help prevent accidents.

Before You Throw Away Your Old Dishwasher:

- Take off the door of the washing compartment or remove the door latch (as shown).

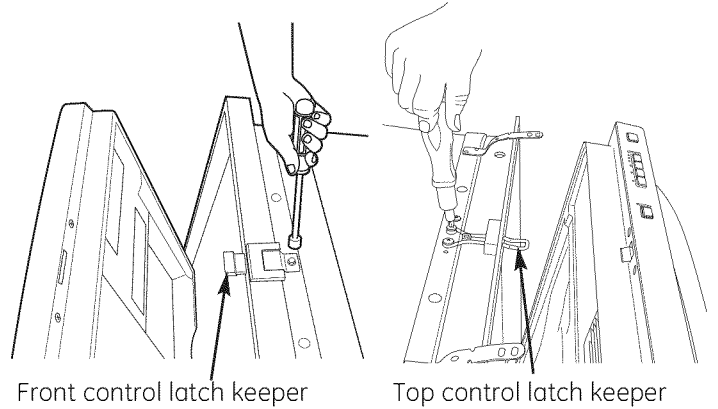

Front control latch keeper

Top control latch keeper

⚠️ ¡ADVERTENCIA! RIESGO DE QUE UN NIÑO QUEDE ATRAPADO

FORMA ADECUADA DE DESCARTAR EL LAVAVAJILLAS

Los lavavajillas antiguos o abandonados son peligrosos... incluso aunque se conserven por "sólo unos pocos días". Si se deshará de su antiguo refrigerador, siga las siguientes instrucciones a fin de evitar accidentes.

Antes de Descartar su Antiguo Lavavajillas:

- Retire la puerta del compartimiento de lavado o retire la traba de la puerta (como se muestra).

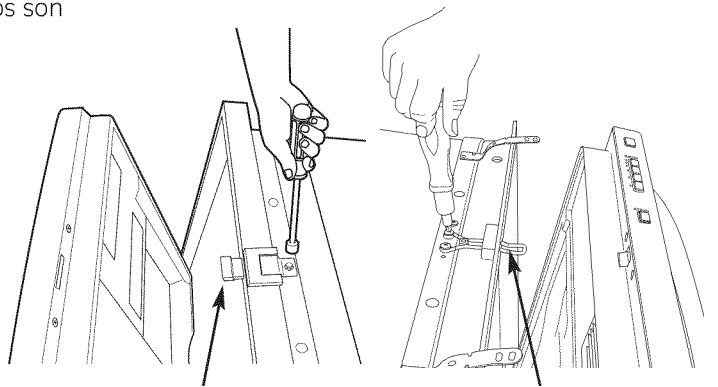

Control frontal de la traba de seguridad

Control superior de la traba de seguridad

IMPORTANT SAFETY INFORMATION

READ ALL INSTRUCTIONS BEFORE USING—

SAVE THESE INSTRUCTIONS



⚠ WARNING! *When using your dishwasher, follow basic precautions, including the following:*

- Use this appliance only for its intended purpose as described in this Owner's Manual.
- Use only powder, **Cascade® Complete Action Packs**, liquid detergents or rinse agents recommended for use in a dishwasher and keep them out of the reach of children. **Cascade®** and **Cascade® Complete Automatic Dishwashing Detergents**, and **Cascade® Rinse Aid** rinse agents have been approved for use in all GE dishwashers.
- Locate sharp items so that they are not likely to damage the door seal.
- Load sharp knives with the handles up to reduce the risk of cut-type injuries.
- Do not wash plastic items unless marked dishwasher safe or the equivalent. For plastic items not so marked, check the manufacturer's recommendations.
- Do not touch the heating element during or immediately after use.
- Do not operate your dishwasher unless all enclosure panels are properly in place.
- Do not tamper with controls.
- Do not abuse, sit on or stand on the door or dish rack of the dishwasher.
- Do not allow children to play around the dishwasher when opening or closing the door due to the possibility of small fingers being pinched in the door.
- Do not discard a dishwasher without first removing the door of the washing compartment or the door latch.
- Do not store or use combustible materials, gasoline or other flammable vapors and liquids in the vicinity of this or any other appliance.
- Do not allow children to play with, on or inside this or any discarded appliance.

⚠ ¡ADVERTENCIA! *Al usar su lavavajillas, siga las precauciones básicas, incluyendo lo siguiente:*

- Use este electrodoméstico sólo para su propósito original, como se describe en el Manual del Propietario.
- Use sólo polvo, **Paquetes de Acción Completa de Cascade®**, detergentes líquidos o agentes de enjuague recomendados para uso en un lavavajillas, y mantenga los mismos fuera del alcance de los niños. Los Detergentes para Lavado en Lavavajillas Automáticos **Cascade® y Cascade® Complete**, y los agentes de enjuague de **Cascade® Rinse Aid** fueron aprobados por su uso en todos los lavavajillas de GE.
- Ubique artículos puntiagudos de modo que no haya posibilidades de daños sobre el sellador de la puerta.
- Ubique artículos puntiagudos de modo que no haya posibilidades de daños sobre el sellador de la puerta.
- No lave artículos de plástico, a menos que figure que son seguros para uso en lavavajillas o una indicación equivalente. Si se trata de artículos de plástico que no cuentan con dicha indicación, consulte las recomendaciones del fabricante.
- No toque el elemento de calefacción durante o inmediatamente después del uso.
- No toque el elemento de calefacción durante o inmediatamente después del uso.
- No toque el elemento de calefacción durante o inmediatamente después del uso.
- No abuse, no se siente ni se pare sobre la puerta o la bandeja del plato del lavavajillas.
- No permita que los niños jueguen alrededor del lavavajillas al abrir o cerrar la puerta, debido a la posibilidad de que sus dedos pequeños sean presionados contra la puerta.
- No permita que los niños jueguen alrededor del lavavajillas al abrir o cerrar la puerta, debido a la posibilidad de que sus dedos pequeños sean presionados contra la puerta.
- No guarde ni use materiales combustibles, gasolina u otros vapores inflamables y líquidos cerca de éste ni de otros electrodomésticos.
- No guarde ni use materiales combustibles, gasolina u otros vapores inflamables y líquidos cerca de éste ni de otros electrodomésticos.



READ AND FOLLOW THIS SAFETY INFORMATION CAREFULLY.
SAVE THESE INSTRUCTIONS

About the dishwasher control panel.

You can locate your model number on the tub wall just inside the door. Throughout this manual, features and appearance may vary from your model.

Front-Control Dishwashers

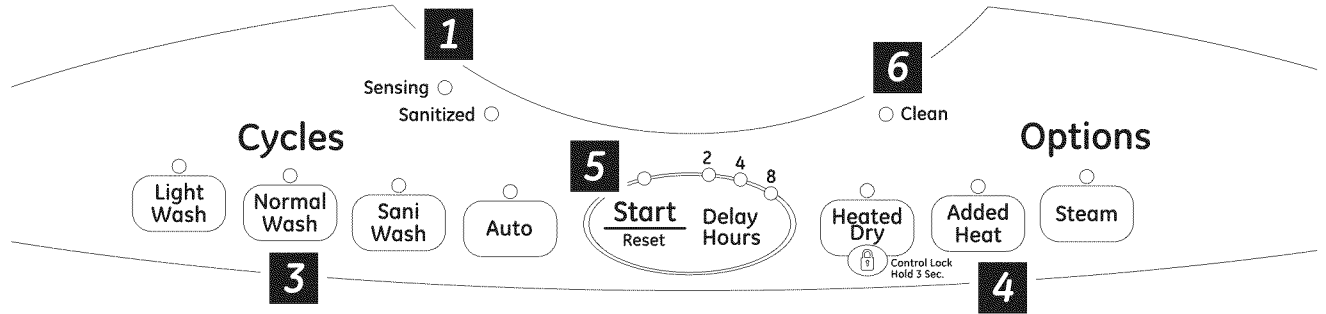

Top-Control Dishwashers

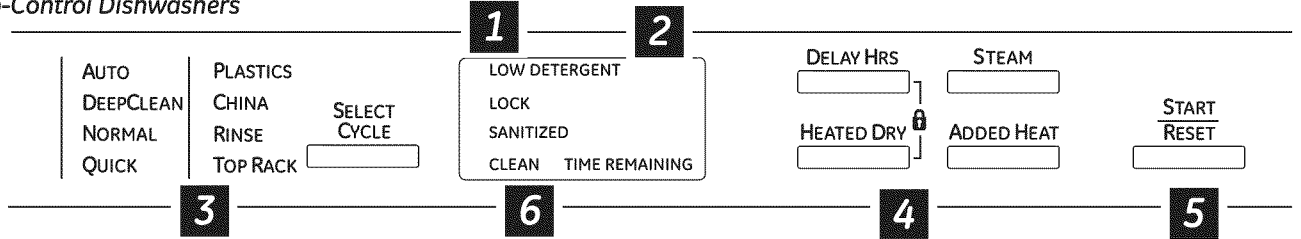

Control Settings

1 Status Indicator Lights (Indicators vary by models)

The Status display tells you what is happening while the dishwasher is in operation and may flash, indicating a malfunction. The lights will come **ON** indicating the sequence of the dishwasher operation.

LOW DETERGENT Displayed when the SmartDispense™ needs to be refilled with liquid or gel automatic dishwasher detergent.

NOTE: If you are not using SmartDispense™ and you want to turn the **LOW DETERGENT** LED light off, press the **ADDED HEAT** button 5 times within 3 seconds. You will hear 3 beeps; then the light will go off. You can turn the light back on by pressing the **ADDED HEAT** button 5 times within 3 seconds.

SENSING Displayed while the Clean Sensor™ is measuring the amount of soil and temperature of water. The dishwasher will adjust the selected cycle to achieve optimal performance.

SANITIZED Displayed at the end of the cycle when SANITIZE has been selected and the dishwasher has met the requirements for sanitization. See SANITIZE, below, for complete cycle description. Opening the door or pressing any key while the door is closed and latched will turn off the light.

CLEAN Displayed when a wash cycle is complete. Refer to Item 6, page 9, for further explanation of clean light operation

CYCLE STATUS INDICATOR The cycle status indicator light is located on the right side of the dishwasher, above the handle. This light comes on as amber while the selected cycle is running. The light turns to green when the selected cycle is complete. The light stays **ON** as green as a reminder that the dishes are clean until the door is opened or until another cycle is selected.

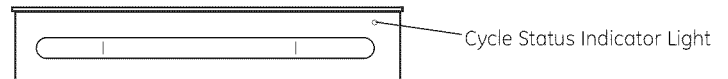

2 Time Remaining Display (on some models)

During operation, the display shows the minutes remaining until the cycle is complete. The display may adjust the remaining time while the Sensing light is on. The time displayed at the start of each cycle may change from the factory setting as the unit customizes itself to home use. During a delay start, the display will show hours of time remaining until the cycle starts.

NOTE: This dishwasher is equipped with CleanSensor™ with automatic temperature control; therefore, cycle length and time may vary depending on soil and water temperature conditions.

3 Wash Programs (Selections)

Front-Control Dishwashers: Close and latch door. Press the button for the desired wash cycle.
 Top-Control Dishwashers: Use the Select Cycle button to scroll through the wash cycles while the door is open.

NOTE: All cycle times and water usage information contained in the following section are approximate values. Actual results will depend on several factors, including but not limited to inlet temperature and amount of soil in the wash water.

The light above or next to the selected button will be **ON** to indicate which **WASH CYCLE** has been selected.

Wash Program	Time (minutes)	Water Usage (gallons/cycle)	Food Soil Level	Description
Sanitize/ Sani Wash	50-135	7.5-8.75	Light to heavy	This cycle raises the water temperature in the final rinse to sanitize your dishware. NOTE: This cycle is monitored for sanitization requirements. If the cycle is interrupted during or after the main wash portion or if the incoming water temperature is so low that adequate water heating cannot be achieved, the sanitizing conditions may not be met. In these cases, the sanitized light will not illuminate at the end of the cycle. When using this cycle, do not open the dishwasher door in the final rinse.
Deep Clean/ Scour	115-175	10	Heavy to baked on food	This cycle is meant for heavily soiled dishes or cookware with dried on or baked on soils. Every day dishes are safe to be used in this cycle. NOTE: On some models the STEAM enhancement will be automatically selected when this cycle is selected, and cannot be deselected. NOTE: This cycle is monitored for sanitization requirements. If the cycle is interrupted during or after the main wash portion or if the incoming water temperature is so low that adequate water heating cannot be achieved, the sanitizing conditions may not be met. In these cases, the sanitized light will not illuminate at the end of the cycle. When using this cycle, do not open the dishwasher door in the final rinse.
Cookware/ Pots & Pans	75-140	8.75-10	Heavy to baked on food	This cycle is meant for heavily soiled dishes or cookware with dried on or baked on soils. Everyday dishes are safe to be used in this cycle.
Auto	62-114	5.2	Light to heavy	This cycle is meant for light to heavily soiled dishes.
Normal	68-118	3.75-5.2	Normally soiled dishes	This cycle is meant for normal every day soil levels and is designed to conserve both water and energy. The Normal cycle was used to rate the efficiency of this dishwasher.
China/ Crystal Light Wash	40-60	7.5	Light to Normal	This cycle is specifically designed for delicate ware such as crystal and china by maintaining lower temperatures.
Glasses	40-75	7.5	Light to normal	This cycle is specifically designed for glasses.
Plastics	85-145	6.25-7.5	Light to heavy	This cycle is specifically designed for plastic ware and includes a built in drying portion that is specifically designed to reduce the risk of melting plastic items and improve plastic drying.
Top Rack	50-110	5-8.75	Light	Upper rack only.
Rinse	11	2.5	Any	For rinsing partial loads that will be washed later. Do not use detergent with this cycle.

NOTE: Only the **Sanitize, Sani Wash, Deep Clean** and **Scour** cycles have been designed to meet the requirements of Section 6, NSF 184 for soil removal and sanitization efficacy.

NOTE: NSF-certified residential dishwashers are not intended for licensed food establishments.

About the dishwasher control panel.

4 Enhancements

The light above the selected button will be **ON** to indicate which **ENHANCEMENT** has been selected.

ENHANCEMENTS	DESCRIPTION
DELAY HOURS	<p>You can delay the start of a wash cycle for up to 24 hours (depending on model). Press the DELAY START button to choose the number of hours you want to delay the start of the cycle; then press START/RESET.</p> <p>Front-Control Dishwashers: The machine will count down and start automatically at the correct time.</p> <p>Top-Control Dishwashers: After closing the door, the machine will count down and automatically start at the correct time.</p> <p>NOTE: To cancel the DELAY START selection before the cycle begins, repeatedly press the DELAY START button until the display is blank.</p>
ADDED HEAT	<p>When selected, the cycle will run longer with heating element on to improve both wash and dry performance.</p> <p>NOTE: Cannot be selected with RINSE AND HOLD cycle.</p>
STEAM	<p>For use with heavily soiled and/or dried-on, baked-on soils. This option MUST be selected PRIOR to starting the cycle. The STEAM option adds 26 minutes to the cycle time.</p> <p>NOTE: Cannot be selected with RINSE AND HOLD cycle.</p>
HEATED DRY	<p>When HEATED DRY is off, dishes will air dry. Top-control models have a fan that assists the drying process.</p> <p>Light Off: Shuts off the drying heat option. Dishes will air dry naturally (front-control dishwashers) or fan dry (top-control dishwashers) to save energy.</p> <p>Light On: Turns the heater on for faster drying. This will extend the total cycle time between 8 and 38 minutes depending on the cycle selected.</p> <p>NOTE: Cannot be selected with RINSE AND HOLD cycle.</p>
LOCK 	<p>You can lock the controls to prevent any selections from being made. Or you can lock the controls after you have started a cycle.</p> <p>Children cannot accidentally start dishwasher by touching buttons with this option selected.</p> <p>Front Control: To unlock the dishwasher controls, press and hold the HEATED DRY button for 3 seconds. The light above the lock button will turn off. To lock the dishwasher, press and hold the HEATED DRY button for 3 seconds. The light above the LOCK button will turn on.</p> <p>Top Control: To unlock the dishwasher controls, press and hold the HEATED DRY and DELAY HOURS buttons for 3 seconds. The lock status indicator light will turn off. To lock the dishwasher, press and hold the HEATED DRY and DELAY HOURS buttons for 3 seconds. The lock status indicator light will turn on.</p>
START/RESET	<p>For top control models, open the door slowly. For front control models leave the door closed, then follow below.</p> <p>To change a cycle after washing starts, touch the START/RESET button to cancel the cycle.</p> <p>The START/RESET LED will turn off and the drain pump will pump water out of the dishwasher for 75 seconds and then turn off. Cycle selection and option LED's will remain on, and buttons will respond during pump out. If the START/RESET is pressed while the dishwasher is in pump out, the START/RESET LED will turn on and the dishwasher will start a new wash cycle.</p>

5 Start

Front-Control Dishwashers

Close and latch the dishwasher door and select the cycle and desired enhancements. Touch the **START/RESET** button one time to begin the cycle. Water fill begins immediately, and approximately 60 seconds later the wash action begins.

When the dishwasher door is fully closed and latched, the control panel lights will display the last settings you selected. If you don't want to change any of the settings, simply touch the **START/RESET** button to begin the cycle.

If the door is closed, the indicator lights will turn off if the **START/RESET** button is not selected within 5 minutes. To activate the display, open and close the door or press any button.

5 *Start (continued)*

Top-Control Dishwashers

After selecting the cycle and desired enhancements, touch the **START/RESET** button to ready the dishwasher to begin the cycle. Close the door to start the cycle or begin the **DELAY START** countdown. When the cycle starts, the water fill begins and approximately 60 seconds later the wash action begins.

The dishwasher will always display your last selection and enhancements. If you don't want to change the settings, simply touch the **START/RESET** button to ready the dishwasher and close the door to begin the cycle.

ALL MODELS: If a power failure occurs **AUTO** and **HEATED DRY** will automatically be programmed. Make any new selections and touch the **START/RESET** button to begin the new cycle.

When the door is opened, the indicator lights will turn off if the **START/RESET** button is not selected within 5 minutes. To activate the display, open and close the door or touch any button.

6 *Clean*

Front-Control Dishwasher

The **CLEAN** light will illuminate and a double beep will sound when a wash cycle is complete. On some models, the **CLEAN** light will turn off when the door is opened. On other models, the **CLEAN** light will remain on until the door is opened and then relatched or until any keypad is pressed while the door is latched shut.

Top-Control Dishwasher

The **CLEAN** light will illuminate and a double beep will sound when a wash cycle is complete. The **CLEAN** light will remain on until the door is opened and then relatched or until any key is pressed.

ALL MODELS: To turn off the audible end-of-cycle signal (or re-activate it if it was previously turned off), press the **HEATED DRY** button 5 times within 3 seconds. A triple beep will sound to indicate the end-of-cycle beep option has been toggled.

Recommended dishwasher products.

GE recommends the following products for use in its dishwashers:

- For your manual detergent dispenser, **Cascade®** Complete ActionPacs are recommended. Powders, liquids, and gels may also be used but may not work as effectively. See page 11 for more details.
- For your SmartDispense™ Detergent Dispenser, **Cascade®** Complete gel is recommended. See page 12 for differences between liquid gel types and a warning about mixing liquid detergents together.

- **Cascade® Rinse Aid™** rinse agent to remove spots and prevent new film buildup on your dishes, glasses, flatware, cookware and plastic. Using rinse agent also improves dry performance.

Using the dishwasher.



Check the Water Temperature

The entering water should be at least 120°F and not more than 150°F for effective cleaning and to prevent dish damage. Check the water temperature with a candy or meat thermometer. Turn on the hot water faucet nearest the dishwasher, place the thermometer in a glass and let the water run continuously into the glass until the temperature stops rising.



Use Cascade® Rinse Aid™ Rinse Agent

Cascade® Rinse Aid™ rinse agent improves drying, removes spots and prevents new film buildup on your dishes, glasses, flatware, cookware and plastic.

Filling the Dispenser

The rinse agent dispenser holds 3.5 oz. of rinse agent. Under normal conditions, this will last approximately one month. Try to keep it full, but do not overfill.

- 1 Make sure the dishwasher door is fully open.
- 2 Turn the dispenser cap to the left and lift it out.
- 3 Add rinse agent until the indicator window is full.
- 4 Clean up any spilled rinse agent with a damp cloth.
- 5 Replace the dispenser cap.

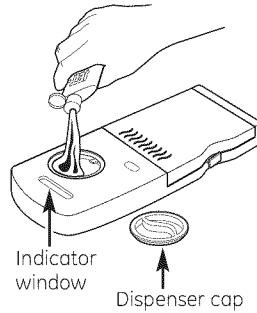

Rinse Aid Setting

The amount of rinse agent released into the final rinse can be adjusted. The factory setting is at the midpoint. If there are rings of calcium (hard water) spots on dishes, try a higher setting. If there is foaming, use a lower setting.

To adjust the setting:

Remove the dispenser cap; then turn the adjuster counterclockwise to increase the amount of rinse agent or clockwise to reduce the amount of rinse agent dispensed.

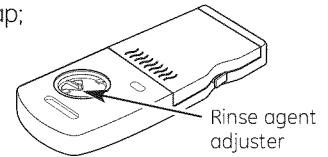

Dish Preparation Prior to Loading

- No prerinseing of normal food soil is required.
- Scrape off hard soils, bones, toothpicks, skins and seeds.
- Remove large quantities of any remaining food.
- Remove leafy vegetables, meat trimmings and excessive amounts of grease or oil.



Forget to Add a Dish?

A forgotten dish can be added any time, however, for best wash performance it is recommended to add a dish prior to the opening of the detergent cup.

- 1 Squeeze the door latch to release the door.
- 2 Do not open the door until the water spray action stops. Steam may rise out of the dishwasher.
- 3 Add forgotten dishes.
- 4 Close the door and dishwasher will start in 5 seconds.

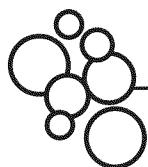

Detergent Dispenser

The detergent dispenser is on the upper left hand side of the dishwasher door. It has two compartments. Use the main wash compartment for all loads. Use the pre-wash compartment only when your water is extremely hard or when you have a heavy soiled load.

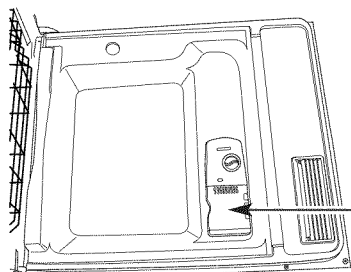

Manual Detergent Dispenser

You may use tablet, powder, liquid or gel automatic dishwasher detergent. Make sure you use only detergents specifically labeled for use in automatic dishwashers. Never use liquid hand dish detergent in an automatic dishwasher. Sudsing and poor wash performance will result with the use of improper detergents.

Detergents should be stored in a dry location and in their original container to prevent loss of effectiveness. Place detergent in the cup just prior to starting the dishwasher and then close and latch the cover. The cover will open during the wash cycle.

Filling the Detergent Dispenser

GE recommends using detergent in tablet or packet form. Independent testing has shown this form of detergent is very effective in the dishwasher. **Cascade® Complete Action Packs** are an example of this type of detergent. Simply put a tablet or packet into the main wash compartment and then close and latch the detergent cup cover. Please notice that the tablet or packet must be placed in the main wash compartment of the detergent cup. If the tablet or packet is tossed in the bottom of the dishwasher, the detergent will be flushed down the drain in a very short period of time and will thus be wasted. Wash performance will be very poor as a result.

If you choose to use detergent in powder, liquid or gel form, the amount of detergent you use will be determined by the hardness of your water, the temperature of your water, and the food soil load inside the dishwasher. Contact your water company to get information about the hardness of the water in your area. Alternatively, you may purchase a hard water test strip from GE. Call 1-800-626-2002 and ask for part number **WD01X10295**.

Number of Grains	Detergent Cups to Fill
Less than 4	Fill cup to soft line (1/3 full)
4 to 8	Fill cup to medium soft line (2/3 full)
8 to 12	Fill cup to medium hard line (completely full)
Greater than 12	Fill both main wash cup and pre wash cup

Using too much detergent with very soft and/or very hot water may cause a condition called etching on your glassware. Etching is a permanent cloudiness in your glassware. This condition is irreversible. However, using too little detergent will cause poor wash performance.

Use the table as a starting point and then adjust the amount of detergent you use. Use just enough to get good wash performance. Using just the right amount of detergent will provide great wash performance without wasting detergent or etching of glassware.

DO NOT USE HAND DISH DETERGENT

NOTE: Using a detergent that is not specifically designed for dishwashers will cause the dishwasher to fill with suds. During operation, these suds will spill out of the dishwasher vents, covering the kitchen floor and making the floor wet.

Because so many detergent containers look alike, store the dishwasher detergent in a separate space from all other cleaners. Show anyone who may use the dishwasher the correct detergent and where it is stored.

While there will be no lasting damage to the dishwasher, your dishes will not get clean using a dishwashing

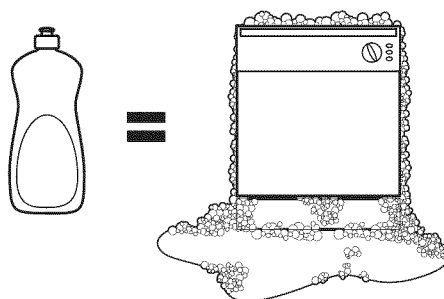

detergent that is not formulated to work with automatic dishwashers.

Using the dishwasher.

SmartDispense™ Detergent Dispenser (some models)

This dishwasher may have SmartDispense™, a feature which automatically dispenses liquid automatic dishwasher detergent into each cycle based on soil level and water hardness. To utilize the SmartDispense™ Detergent Dispenser, it must first be filled. Although any liquid or gel automatic dishwashing detergent can be used in the SmartDispense™ system, all liquid or gel automatic dishwashing detergents are not the same. Most automatic dishwashing detergents are chlorine bleach-based (such as Cascade®) while others contain enzymes (such as Cascade Complete®).

Do not mix any chlorine bleach-based automatic dishwashing detergent with any dishwashing detergent containing enzymes as this could cause the detergents to congeal and lead to blockage of the SmartDispense™ system.

Check the detergent label to determine if the detergent is chlorine bleach-based or one that contains enzymes. It is recommended that the same type of detergent be used when refilling your SmartDispense™ system.

⚠ CAUTION! Absolutely do not add powder detergent, tablets or any liquid soap or detergent normally used for washing hands or dishes in a sink. Only use liquid or gel detergent specifically designed for use in an automatic dishwasher.

⚠ ¡PRECAUCIÓN! Bajo ninguna circunstancia agregue detergente en polvo, tabletas o jabón o detergente líquido normalmente utilizado para lavar manos o platos en un fregadero. Sólo utilice detergente líquido o en gel específicamente diseñado para utilizar en lavaplatos automáticos.

To open the dispenser for filling, push down and turn the blue cap counterclockwise until the cap is loose. Lift cap off.

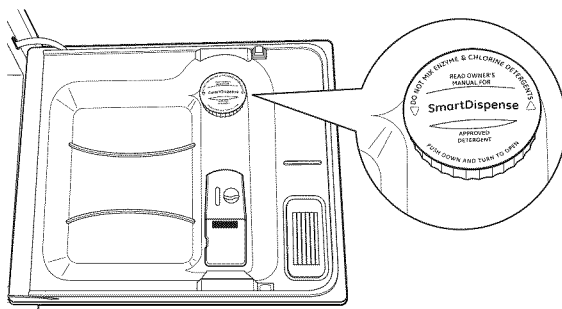

Set the door at a comfortable angle to fill the dispenser.

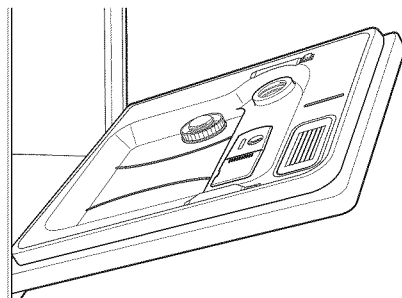

Aim the detergent bottle at the opening in the door and begin to fill.

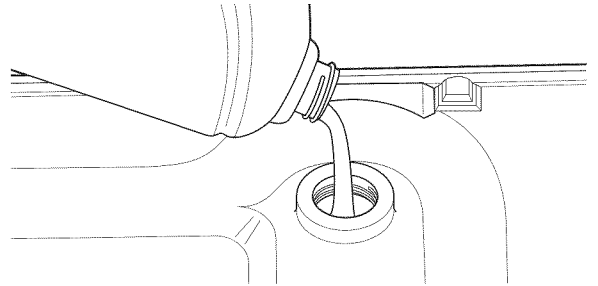

The dispenser will hold 45 oz of liquid dishwasher detergent (standard size bottle).

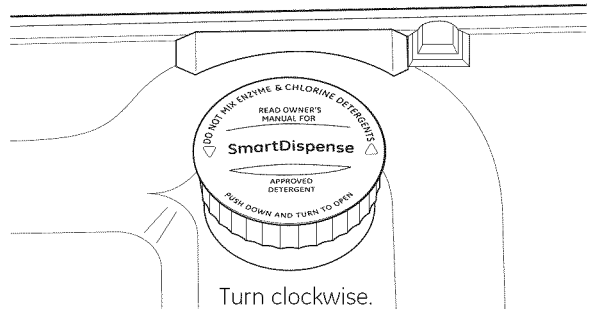

When full, replace the cap and turn clockwise until tight to ensure no water enters the SmartDispense™ dispenser. If residue is left on the door, it will be washed off in the next cycle.

An indicator light will turn on to notify you when the dispenser needs to be filled again. After filling, the light will not turn off until the door is closed. A full dispenser will last approximately 1 month for the average user.

STATUS

Light Will Turn On When Time to Refill	○ LOW DETERGENT	● DRYING
	● SENSING	● SANITIZED
	● WASHING	● CLEAN
(appearance may vary)		

NOTE: If you are not using SmartDispense™ and you want to turn the **LOW DETERGENT** LED light off, press the **ADDED HEAT** button 5 times within 3 seconds. You will hear 3 beeps; then the light will go off. You can turn the light back on by pressing the **ADDED HEAT** button 5 times within 3 seconds.

SmartDispense™ Detergent Dispenser Water Hardness Calibration

Prior to the first use, the dishwasher needs to be calibrated for water hardness. Please follow the directions below to calibrate the dishwasher to the hardness of your tap water.

Determine the Hardness of Your Tap Water

In the bag that contained these instructions, you should find a water hardness test strip package. Read the instructions on the package, remove the test strip and follow the instructions to determine the hardness level of your tap water. You will use this information to calibrate your dishwasher to dispense the optimal amount of detergent.

Calibration of Front-Control Models With 3-Digit Display

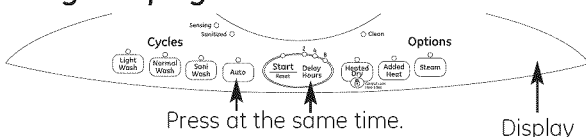

- 1 Close and latch the door (lights on, dishwasher not running).
- 2 Press the **AUTO** and **DELAY HOURS** buttons at the same time for 3 seconds. The display will show a number from 1 to 5. This is the water hardness value currently set.
- 3 Press the **AUTO** button to raise the value or the **NORMAL** button to lower the value. Set the water hardness value to the number determined with the test strip and table above.
- 4 Once the water hardness is set, press the **START/RESET** button to save the setting and return the dishwasher to normal operation.

Calibration of Front-Control Models Without a 3-Digit Display

- 1 Close and latch the door (lights on, dishwasher not running).
- 2 Press the **AUTO** button and **DELAY HOURS** buttons at the same time for 3 seconds. All lights will light up and you will hear 1 to 5 beeps. The number of beeps indicates the current hardness value.
- 3 To change the setting, press the **DELAY HOURS** button the number of times that corresponds to the water hardness value determined at the left. The control will beep each time you press the button.
- 4 Once finished pressing the button, you will hear a confirmation with beeps for the hardness value selected.
- 5 If the number of beeps is not what you desire, start pressing the **DELAY HOURS** button again to reenter a new water hardness level.
- 6 Once the water hardness is set, press the **START/RESET** button to save the setting and return the dishwasher to normal operation.

Water hardness test strip indication.

		Value to Enter into Dishwasher
SOFT	0 RED	1
	1 RED	2
	2 RED	3
	3 RED	4
HARD	4 RED	5

Calibration of Top-Control Models With 3-Digit Display

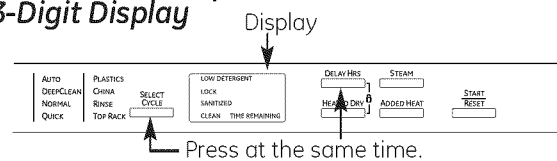

- 1 Open the door and touch any button other than **START** to turn lights on.
- 2 Press the **Select Cycle** button and **DELAY HOURS** button at the same time for 3 seconds. The display will show a number from 1 to 5. This is the water hardness value currently set.
- 3 Press the **STEAM** button to raise the value or the **Select Cycle** button to lower the value. Set the water hardness value to the number determined with the test strip and table at the left.
- 4 Once the water hardness is set, press the **START/RESET** button to save the setting and return the dishwasher to normal operation.

Calibration of Top-Control Models Without a 3-Digit Display

- 1 Open the door and touch any button other than **START** to turn lights on.
- 2 Press the **Select Cycle** button and **DELAY HOURS** button at the same time for 3 seconds. All lights will light up and you will hear 1 to 5 beeps. The number of beeps indicates the current hardness value.
- 3 To change the setting, press the **DELAY HOURS** button the number of times that corresponds to the water hardness value determined at the left. The control will beep each time you press the button.
- 4 Once finished pressing the button, you will hear a confirmation with beeps for the hardness value selected.
- 5 If the number of beeps is not what you desire, start pressing the **DELAY HOURS** button again to reenter a new water hardness level.
- 6 Once the water hardness is set, press the **START/RESET** button to save the setting and return the dishwasher to normal operation.

NOTE: You should recalibrate the dishwasher control if water conditions change; for example, if a water softener system is added or removed from your home.

Loading the dishwasher racks.

For best dishwashing results, follow these loading guidelines. Features and appearance of racks and silverware baskets may vary from your model.

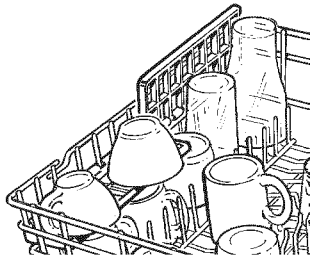

Upper Rack

Although the upper rack is primarily for glasses, cups and saucers, pots and pans can be placed in this rack for effective cleaning. Cups and glasses fit best along the sides. This is also a secure place for dishwasher plastics.

The utility shelf (some models) may be placed in the up or down position to add flexibility. A wine glass holder (some models) secures wine glasses for best washability.

Some models have contoured metal cup shelves that can secure up to 12 wine glasses (as shown).

Because wine glasses come in various sizes, after loading, slowly push in the rack to make sure they will clear the top of the dishwasher.

Some models have an Angled Rack System, which allows you to angle your dishes, such as coffee mugs, for better cleaning and quicker drying. To position the tines, pull the lever forward then drop the tines into position, then release the lever.

The upper rack is good for all kinds of odd-shaped utensils. Saucepans, mixing bowls and other items should be placed face down. Fold-down tines (on some models) provide flexibility for extra-large and hard-to-fit items.

Secure larger dishwasher-safe plastics over 2 tines when possible.

Make sure small plastic items are secure so they can't fall onto the heater.

Be sure that items do not protrude through the bottom of the rack and block rotation of the middle spray arm. This could result in poor wash performance for items in the upper rack.

Check to make sure that no items will block rotation of the wash arm.

NOTE: The Single Rack Wash selection, on models with this feature, washes the upper rack only. If you use this feature, do not load items in the lower rack.

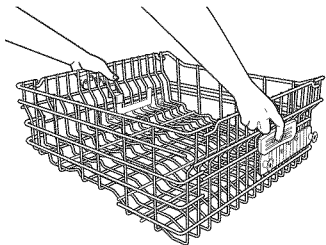
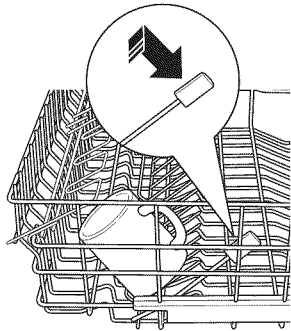
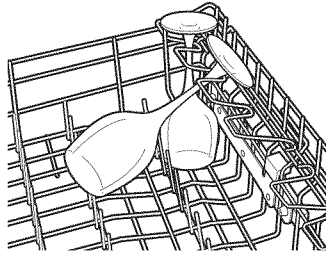

Adjustable Upper Rack (on some models)

The standard position of your adjustable rack is "up" which allows for maximum clearance for your taller items in the lower rack. If you have taller wine glasses, tumblers or other items to place in the upper rack, you may want to adjust the rack to the lower position.

To lower the rack, support the weight of the rack with your hands as shown and press both finger pads about 1/4" toward the inside of the rack as indicated and guide the rack down to its lower position.

To raise the rack to the "up" position, pull up on the center of the rack side frame until the rack locks into place.

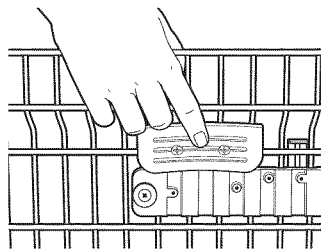

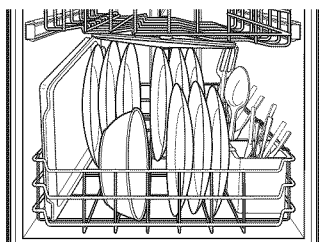

Lower Rack

The lower rack is best used for plates, saucers and cookware. Large items such as broiler pans and baking racks should go along the left-hand side. Load platters, pots and bowls along the sides, in corners or in the back. The soiled side of items should face the center of the rack. If necessary, oversized glasses and mugs can be placed in the lower rack to maximize loading flexibility.

Also, be careful not to let a portion of an item such as a pot or dish handle extend through the bottom rack. This could block the wash arm and cause poor washing results.

Fold-down tines (on some models) provide flexibility for extra-large and hard-to-fit items. The tines may be left in the up position or folded down to customize the lower rack. Do not load large bowls or pots facedown in the front left-hand corner. Items loaded in this manner could prevent proper operation of the manual detergent cup.

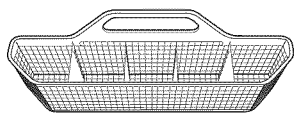

One-piece basket (on some models)

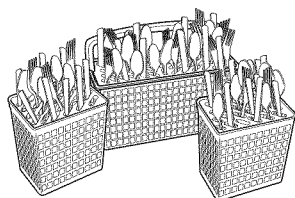

Three-piece basket (on some models)

Silverware Basket

To load flatware, simply push the adjustable handle to either side (on some models). Put flatware in the removable basket with fork and knife handles up to protect your hands. Place spoons in the basket with handles down. Mix knives, forks and spoons so they don't nest together. Distribute evenly. Small plastic items, such as measuring spoons and lids from small containers should go in the bottom of the silverware basket with the silverware on top.

The one-piece silverware basket (on some models) can be placed in the front, right side or back of the lower rack.

A variety of options is available regarding the three-piece silverware basket (on some models) in your dishwasher. The complete basket is designed to fit on the right side of the lower rack. Additionally, each end of the basket is removable to add loading flexibility to accommodate flatware and lower rack capacity needs.

The lids of both end and middle baskets (on some models) can be closed to contain small items. Long items can be placed on the utility shelf in the upper rack. Load flatware through the slots in the silverware basket covers.



Don't let any item extend through bottom.

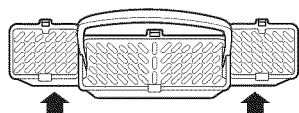

To remove end baskets, grasp the basket at opposite corners and slide apart.

Loading the dishwasher racks.

Extra Rack Features (on some models)

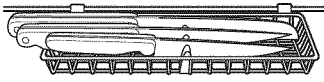

Cutlery Tray

The cutlery tray holds up to 4 large knives such as a carver, chef's knives, bread knife, etc., that are too tall to fit in the silverware basket.

Hook the tray onto the rear of the upper rack. Lay the knives between the guides (as shown).

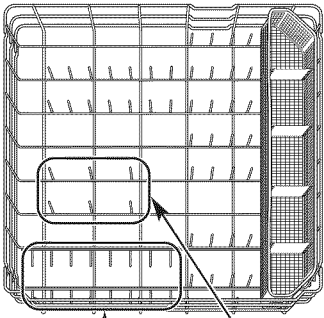

These tines fold down Large-bowl tines

Bowl Tines

The special large-bowl tines in the lower rack add flexibility to your loading pattern. They are useful for serving bowls or other large bowls.

To use the bowl tines, fold down the 2 rows of flex tines in front of the bowl tines and load bowls just as you would in the upper rack.

Loading place settings...

Follow these guidelines for loading 10 place settings. Features and appearance of racks and silverware baskets may vary from your model. **NOTE:** Silverware should be individually loaded into the slots on the silverware basket lid.

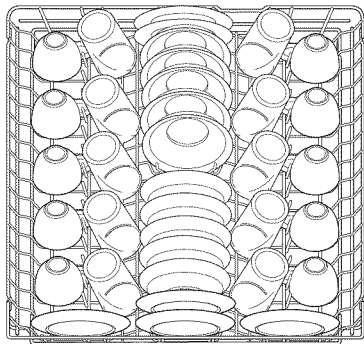

Upper Rack—10 place settings

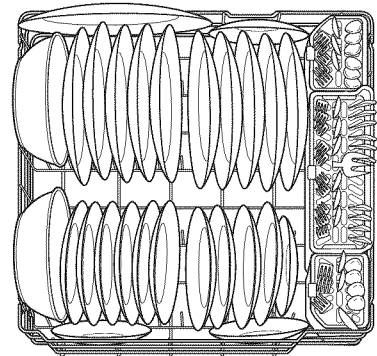

Lower Rack—10 place settings

Follow these guidelines for loading 12 place settings. Features and appearance of racks and silverware baskets may vary from your model. **NOTE:** Silverware should be individually loaded into the slots on the silverware basket lid.

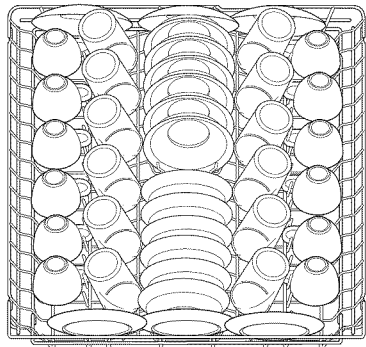

Upper Rack—12 place settings

NOTE: Do not place large objects in the front-left corner of the lower rack.

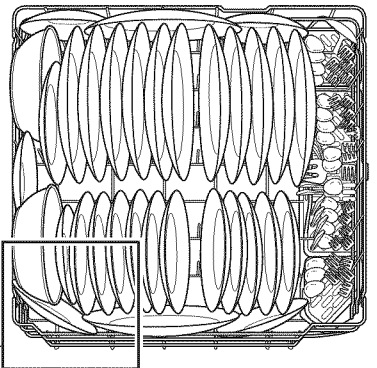

Lower Rack—12 place settings

Cleaning the Exterior Door Panel

Before cleaning the front panel, make sure you know what type of panel you have. Refer to the last two letters of your model number. You can locate your model number on the left-hand tub wall just inside the door. If your model number ends with BB, CC, WW, SA or BG, then you have a Painted Door panel. If your model number ends with SS, then you have a Stainless Steel Door panel. If your model number ends with CS, then you have a CleanSteel panel.

Follow the instructions below for cleaning the door panel for your specific model.

Painted Door Panel (model numbers ending in BB–black, CC–bisque, WW–White, SA–silver metallic or BG–graphite black)

Use a clean, soft, lightly dampened cloth, then dry thoroughly. You may also use a good appliance wax or polish.

Stainless Steel Door Panel (model numbers ending in SS)

The stainless steel panels can be cleaned with *Stainless Steel Magic* or a similar product using a clean, soft cloth. Do not use appliance wax, polish, bleach or products containing chlorine on Stainless Steel doors.

You can order *Stainless Steel Magic* #WX10X15 through GE Parts by calling 800.626.2002.

CleanSteel Door Panel (model numbers ending in CS)

Use a clean, soft, lightly dampened cloth, then dry thoroughly. Do not use appliance wax, polish or any chemical agent on CleanSteel doors.

Do not wipe the dishwasher with a soiled dish cloth or wet towel. These may leave a residue. Do not use scouring pads or powdered cleaners because these products can scratch the finish.

Stainless Steel Interior—Tub and Inner Door

The stainless steel used to make the dishwasher tub and inner door provides the highest reliability available in a GE dishwasher. If the dishwasher tub or inner door should be scratched or dented during normal use, they will not rust or corrode. These surface blemishes will not affect their function or durability.

Cleaning the Control Panel

To clean the control panel, use a lightly dampened cloth. Then dry thoroughly.

Protect Against Freezing

If your dishwasher is left in an unheated place during the winter, ask a service technician to:

- 1 Cut off electrical power to the dishwasher. Remove fuses or trip circuit breaker.
- 2 Turn off the water supply and disconnect the water inlet line from the water valve.

- 3 Drain water from the water inlet line and water valve. (Use a pan to catch the water.)
- 4 Reconnect the water inlet line to the water valve.

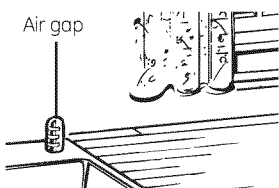

Check the air gap any time your dishwasher isn't draining well.

Does Your Dishwasher Have an Air Gap?

An air gap protects your dishwasher against water backing up into it if a drain clogs. The air gap is not a part of the dishwasher. It is not covered by your warranty. Not all plumbing codes require air gaps, so you may not have one. If the air gap gets clogged, the dishwasher will not drain. Clean the air gap if the dishwasher will not drain.

The air gap is easy to clean.

- 1 Turn off the dishwasher and lift off the cover.
- 2 Remove the plastic cap and clean with a toothpick.

Before you call for service...



Troubleshooting Tips

Save time and money! Review the charts on the following pages, or visit GEAppliances.com. You may not need to call for service.

Error Messages	Possible Causes	What To Do
Dishwasher BEEPS once every minute	This is a reminder that your dishwasher door has been left open during operation. It will continue beeping until you close the door.	<ul style="list-style-type: none"> Close and latch the door after opening it mid-cycle.
Beeping at the end of the cycle	This is normal. The dishwasher will beep twice at the end of the cycle	<ul style="list-style-type: none"> To turn off the double beep indicator (or re-activate it if it was previously turned off), press the HEATED DRY pad 5 times within 3 seconds. A triple beep will sound to indicate the end-of-cycle beep option has been turned on or off.
Dishes and flatware not clean	Low inlet water temperature	<ul style="list-style-type: none"> Make sure inlet water temperature is correct (see page 10). Turn on the hot water faucet nearest the dishwasher, let run until the water temperature stops rising. Then start the dishwasher and turn off the faucet. This insures the entering water is hot.
	Water pressure is temporarily low	<ul style="list-style-type: none"> Turn on a faucet. Is water coming out more slowly than usual? If so, wait until pressure is normal before using your dishwasher.
	Air gap or disposer is clogged	<ul style="list-style-type: none"> Clean the air gap or flush the disposer.
	Improper rack loading	<ul style="list-style-type: none"> Make sure large dishware does not block the detergent dispenser or the wash arms. See the <i>Loading the dishwasher racks</i> section.
	No air gap or high drain loop	<ul style="list-style-type: none"> Verify that you have an air gap or a high drain loop. Refer to the Installation Instructions.
	Poor performing detergent	<ul style="list-style-type: none"> Use a highly rated detergent such as Cascade® Complete.
	Spots and filming on glasses and flatware	Extremely hard water
Low inlet water temperature		<ul style="list-style-type: none"> Make sure water temperature is at least 120°F.
Overloading or improper loading of the dishwasher		<ul style="list-style-type: none"> Load dishwasher as shown in the Loading Place Settings section.
Old or damp powder detergent		<ul style="list-style-type: none"> Make sure detergent is fresh.
Rinse agent dispenser empty		<ul style="list-style-type: none"> If water is extremely hard, a softener may be required.
Too little or low performing detergent		<ul style="list-style-type: none"> Make sure you use the proper amount of highly rated detergent.
Cloudiness on glassware		Combination of soft water and too much detergent
	Low performing phosphate free detergent	<ul style="list-style-type: none"> See <i>White film on inside surface</i> page 20
	Water temperature entering the dishwasher exceeds 150°F (66°C)	<ul style="list-style-type: none"> This could be etching. Lower the water heater temperature.

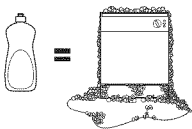
Problem	Possible Causes	What To Do
Suds in the tub	Correct detergent wasn't used 	<ul style="list-style-type: none"> Use only automatic dishwasher detergents to avoid sudsing. Cascade® Automatic Dishwashing Detergents have been approved for use in all GE dishwashers. To remove suds from the tub, open the dishwasher and let suds dissipate. Close and latch the dishwasher door. Pump out water by touching the START/RESET button once; then 30 seconds later, touch the START/RESET button again. Repeat if necessary.
	Rinse agent was spilled	<ul style="list-style-type: none"> Always wipe up rinse agent spills immediately.
Detergent left in dispenser cups	Dishes are blocking the detergent cup	<ul style="list-style-type: none"> Reposition the dishes, so the water from the lower spray arm can flush the detergent cup. See pages 15 and 16.
Black or gray marks on dishes	Aluminum utensils have rubbed against dishes	<ul style="list-style-type: none"> Remove marks with a mild, abrasive cleaner.
Dishes don't dry	Low inlet water temperature	<ul style="list-style-type: none"> Make sure inlet water temperature is at least 120°F. Select HEATED DRY. Use ADDED HEAT options. Select a higher cycle, such as SANI WASH/SANITIZE or DEEP CLEAN.
	Rinse agent dispenser is empty	<ul style="list-style-type: none"> Check the rinse agent dispenser and fill as required.
Control panel responded to inputs but dishwasher never filled with water	Door latch may not be properly seated	<ul style="list-style-type: none"> Make sure the door is firmly closed.
	Water valve may be turned off	<ul style="list-style-type: none"> Make sure water valve (usually located under the sink) is turned on.
Stained tub interior	Some tomato-based foods can cause reddish stains	<ul style="list-style-type: none"> Use of the RINSE AND HOLD cycle after adding the dish to the load can decrease the level of staining.
	Tea or coffee stains	<ul style="list-style-type: none"> Remove the stain by hand, using a solution of 1/2 cup bleach and 3 cups warm water.
<p>⚠ WARNING Before cleaning interior, wait at least 20 minutes after a cycle for the heating elements to cool down. Failure to do so can result in burns.</p> <p>⚠ ADVERTENCIA Antes de limpiar el interior, espere por lo menos 20 minutos después de un ciclo para que los elementos calentadores se enfrien. No hacerlo puede provocar quemaduras.</p>		
Dishwasher won't run	An overall yellow or brown film can be caused by iron deposits in water	<ul style="list-style-type: none"> A special filter in the water supply line is the only way to correct this problem. Contact a water softener company.
	Dishwasher door is not closed and latched	<ul style="list-style-type: none"> Dishwasher door must be closed and latched for dishwasher to operate.
	Fuse is blown or circuit breaker	<ul style="list-style-type: none"> Replace fuse or reset circuit breaker. Remove any other appliances from the circuit.
	Power is turned off	<ul style="list-style-type: none"> In some installations, the power to the dishwasher is provided through a wall switch, often located next to the disposer switch. Make sure it is on.
	Control panel is locked	<ul style="list-style-type: none"> Unlock control panel. See page 8.
	Reboot your control	<ul style="list-style-type: none"> Turn off power to the dishwasher (circuit breaker or wall switch) for 30 seconds; then turn back on.

Before you call for service...



Troubleshooting Tips

Problem	Possible Causes	What To Do
Control panel lights go off when you're setting controls	Time too long between touching of selected buttons	<ul style="list-style-type: none"> Each button must be touched within 5 minutes of the others. To relight, touch any button again, or unlock and relatch door.
Water standing in the bottom of the tub	This is normal	<ul style="list-style-type: none"> A small amount of clean water around the outlet on the tub bottom at the back of the tub keeps the pump seal lubricated.
Water won't pump out of the tub	Drain is clogged	<ul style="list-style-type: none"> If you have an air gap, clean it. See page 17. If the dishwasher drains into a disposer, run disposer clear. Check to see if your kitchen sink is draining well. If not, you may need a plumber.
Steam	This is normal	<ul style="list-style-type: none"> Warm, moist air comes through the vent by the door latch during drying and when water is being pumped out (front-control models). This is normal and necessary for drying.
Sanitized light does not illuminate at the end of the cycle	The door was opened and the cycle was interrupted during or after the main wash portion	<ul style="list-style-type: none"> Do not interrupt the cycle anytime during or after main wash.
	The incoming water temperature was too low	<ul style="list-style-type: none"> Raise the water heater temperature to between 120°F and 140°F.
	The cycle is complete and the door has been open for longer than 60 seconds	<ul style="list-style-type: none"> This is normal. No action is required.
Noise	Normal operating sounds	<ul style="list-style-type: none"> These are all normal. No action is required.
	Detergent cup opening	
	Water entering dishwasher	
The motor stops and starts at various times during the cycle	The motor stops and starts at various times during the cycle	
	Drain pump sounds during pump out	
	Rattling dishes when the spray arm rotates	<ul style="list-style-type: none"> Make sure dishes are properly loaded. See the <i>Loading the dishwasher racks</i> section.
A white film on glassware, dishware and the interior	This problem caused by phosphate-free dishwasher detergent	<ul style="list-style-type: none"> To remove the white film, run your dishes through a dishwasher cycle with citric acid. You may purchase a citric acid kit from GE by calling 1-800-626-2002 and asking for WD35X151. Alternatively, you can purchase citric acid crystals from your local supermarket. <p>Pour the citric acid in the detergent cup and close the cover. Place the filmed but otherwise clean glassware and dishware in the dishwasher. Leave silverware and other metal items out of the dishwasher. Turn the dishwasher on and let it run through a complete cycle without detergent. The glassware, dishware, and dishwasher should come out film free. Alternatively, a vinegar rinse may be used. Pour 1 cup of vinegar into dishwasher just after the detergent cup opens and let the dishwasher complete its cycle. This may be repeated several times a year as needed.</p> <p>The use of a rinse agent such as Cascade® Rinse Aid™ may help minimize a repeat build up of film. Also, the use of a highly rated detergent such as Cascade® Complete Action Pads will help prevent film build-up.</p>

Notes.

Safety Instructions

Operating Instructions

Troubleshooting Tips

Consumer Support

Safety Instructions

Operating Instructions

Troubleshooting Tips

Consumer Support

GE Dishwasher Warranty.



All warranty service provided by our Factory Service Centers, or an authorized Customer Care® technician. To schedule service, on-line, visit us at GEAppliances.com, or call 800.GE.CARES (800.432.2737) in the United States. In Canada, call 1.800.561.3344. Please have serial number and model number available when calling for service.

Staple your receipt here. Proof of the original purchase date is needed to obtain service under the warranty.

For The Period Of: GE Will Replace:

One Year From the date of the original purchase	Any part of the dishwasher which fails due to a defect in materials or workmanship. During this limited one-year warranty , GE will also provide, free of charge , all labor and in-home service to replace the defective part.
Five Years (only for model numbers beginning with PDW or CDW) From the date of the original purchase	The dishwasher racks and the electronic control module if they should fail due to a defect in materials or workmanship. During this five-year limited warranty , you will be responsible for any labor or in-home service costs.
Lifetime of Product (only for model numbers beginning with PDW or CDW)	The Stainless tub or door liner , if it fails to contain water due to a defect in materials or workmanship. During this limited warranty , GE will also provide, free of charge , all labor and in-home service to replace the defective part.

What GE Will Not Cover (for customers in the United States):

- Service trips to your home to teach you how to use the product.
- Improper installation, delivery or maintenance.
- Failure of the product if it is abused, misused, or used for other than the intended purpose or used commercially.
- Replacement of house fuses or resetting of circuit breakers.
- Product not accessible to provide required service.
- Damage to the product caused by accident, fire, floods or acts of God.
- Incidental or consequential damage caused by possible defects with this appliance.
- Cleaning or servicing of the air gap device in the drain line.
- Damage caused after delivery, including damage from items dropped on the door.

EXCLUSION OF IMPLIED WARRANTIES—Your sole and exclusive remedy is product repair as provided in this Limited Warranty. Any implied warranties, including the implied warranties of merchantability or fitness for a particular purpose, are limited to one year or the shortest period allowed by law.

This warranty is extended to the original purchaser and any succeeding owner for products purchased for home use within the USA. If the product is located in an area where service by a GE Authorized Servicer is not available, you may be responsible for a trip charge or you may be required to bring the product to an Authorized GE Service location for service. Proof of original purchase date is needed to obtain service under the warranty. In Alaska, the warranty excludes the cost of shipping or service calls to your home.

Some states do not allow the exclusion or limitation of incidental or consequential damages. This warranty gives you specific legal rights, and you may also have other rights which vary from state to state. To know what your legal rights are, consult your local or state consumer affairs office or your state's Attorney General.

Warrantor: General Electric Company, Louisville, KY 40225

What Is Not Covered (for customers in Canada):

- Service trips to your home to teach you how to use the product.
- Improper installation.
If you have an installation problem, contact your dealer or installer. You are responsible for providing adequate electrical, exhausting and other connecting facilities.
- Failure of the product if it is abused, misused, or used for other than the intended purpose or used commercially.
- Replacement of house fuses or resetting of circuit breakers.
- Damage to the product caused by accident, fire, floods or acts of God.
- Damage caused after delivery.

EXCLUSION OF IMPLIED WARRANTIES—Your sole and exclusive remedy is product repair as provided in this Limited Warranty. Any implied warranties, including the implied warranties of merchantability or fitness for a particular purpose, are limited to one year or the shortest period allowed by law.

This warranty is extended to the original purchaser and any succeeding owner for products purchased in Canada for home use within Canada. In home warranty service will be provided in areas where it is available and deemed reasonable by Mabe to provide.

WARRANTOR IS NOT RESPONSIBLE FOR CONSEQUENTIAL DAMAGES.

Warrantor: MABE CANADA INC.

Consumer Support.



GE Appliances Website

In the U.S.: **GEAppliances.com**

Have a question or need assistance with your appliance? Try the GE Appliances Website 24 hours a day, any day of the year! For greater convenience and faster service, you can now download Owner's Manuals, order parts or even schedule service on-line. **In Canada: www.GEAppliances.ca**

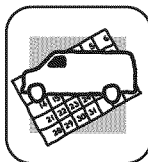

Schedule Service

In the U.S.: **GEAppliances.com**

Expert GE repair service is only one step away from your door. Get on-line and schedule your service at your convenience any day of the year! Or call 800.GE.CARES (800.432.2737) during normal business hours.

In Canada, call 1.800.561.3344

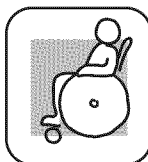

Real Life Design Studio

In the U.S.: **GEAppliances.com**

GE supports the Universal Design concept—products, services and environments that can be used by people of all ages, sizes and capabilities. We recognize the need to design for a wide range of physical and mental abilities and impairments. For details of GE's Universal Design applications, including kitchen design ideas for people with disabilities, check out our Website today. For the hearing impaired, please call 800.TDD.GEAC (800.833.4322).

In Canada, contact: Manager, Consumer Relations, Mabe Canada Inc.
Suite 310, 1 Factory Lane
Moncton, N.B. E1C 9M3



Extended Warranties

In the U.S.: **GEAppliances.com**

Purchase a GE extended warranty and learn about special discounts that are available while your warranty is still in effect. You can purchase it on-line anytime, or call 800.626.2224 during normal business hours. GE Consumer Home Services will still be there after your warranty expires. **In Canada, call 1.888.261.2133**

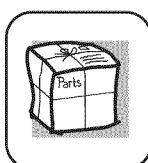

Parts and Accessories

In the U.S.: **GEAppliances.com**

Individuals qualified to service their own appliances can have parts or accessories sent directly to their homes (VISA, MasterCard and Discover cards are accepted). Order on-line today, 24 hours every day or by phone at 800.626.2002 during normal business hours.

Instructions contained in this manual cover procedures to be performed by any user. Other servicing generally should be referred to qualified service personnel. Caution must be exercised, since improper servicing may cause unsafe operation.

Customers **in Canada** can order parts and accessories on-line at www.GEAppliances.ca, 24 hours every day, or by phone at 1.800.661.1616 during normal business hours.



Contact Us

In the U.S.: **GEAppliances.com**

If you are not satisfied with the service you receive from GE, contact us on our Website with all the details including your phone number, or write to:

General Manager, Customer Relations
GE Appliances, Appliance Park
Louisville, KY 40225

In Canada: www.GEAppliances.ca, or write to: Director, Consumer Relations, Mabe Canada Inc.
Suite 310, 1 Factory Lane
Moncton, N.B. E1C 9M3



Register Your Appliance

In the U.S.: **GEAppliances.com**

Register your new appliance on-line—at your convenience! Timely product registration will allow for enhanced communication and prompt service under the terms of your warranty, should the need arise. You may also mail in the pre-printed registration card included in the packing material. **In Canada: www.GEAppliances.ca**