

This Owner's Manual is provided and hosted by Appliance Factory Parts.

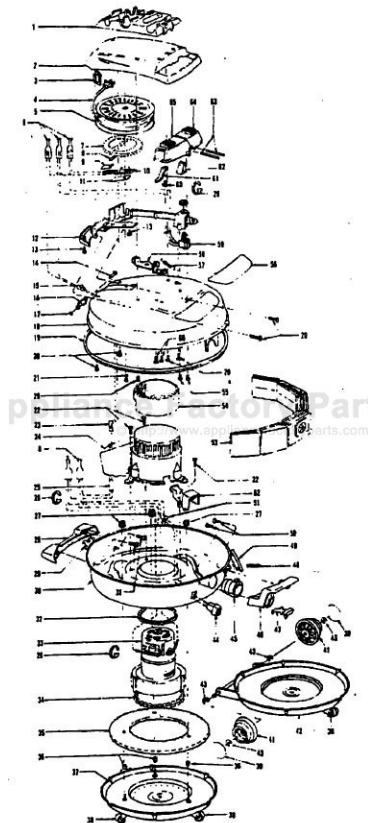

HOOVER S3139 Owner's Manual

[Shop genuine replacement parts for HOOVER S3139](#)



[Find Your HOOVER Vacuum Cleaner Parts - Select From 1456 Models](#)

----- Manual continues below part list -----

Available Replacement Parts for HOOVER S3139

H-43267002	AGITATOR BEARING ASM
H-4010009H	PAPER BAG, 3 PK
H-43414073	Floor brush.
H-43414064	DUSTING BRUSH (ONE PEICE)

Celebrity Motor

Models S3129, S3137, S3171, S3187, S3193,
S3195, S3199, S3201, S3219, S3237, S3239

Motor - 2 Speed 43577093 (3.7)

Motor - 43577101 (2.6)

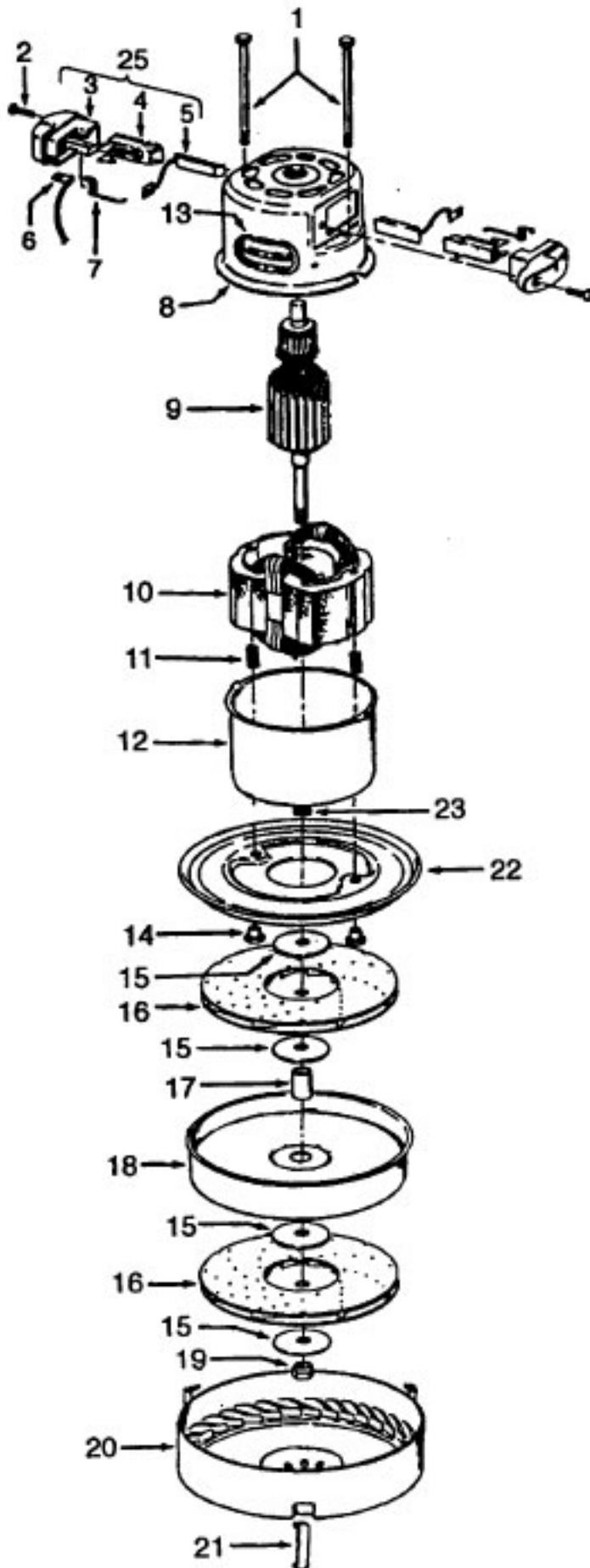

Ref. No.	Part No.	Description
	43577101	Motor - (2.6) S3129, S3137, S3171, S3187, S3193, S3195, S3219
	43577093	Motor Comp. - (3.7) S3199, S3201, S3237, S3239
1	12022	Field Bolt
2	21429406	Screw
3	168038	Brush Carrier
4	168506--	Brush Holder
5	167679	Carbon Brush
6	27666551	Terminal
7	38353004	Spring
8	169706	Motor Housing - Upper
9	44765078	Armature (2.6)
	44765106	Armature (3.7)
10	45311017	Field Coll (2.6)
	45311018	Field Coll (3.7) 2-Speed
11	167721FW	Spring (3.7)
	38311016	Spring (2.6)
12	41823001	Motor Housing - Lower
13	169702BZ	Bushing
14	167695EF	Nut
15	21312774	Washer
16	43566006	Fan
17	31732003	Spacer
18	169712	Interstage
19	33426001	Nut
20	37218005	Diffuser
21	34786002	Spring Clip
22	169713FW	Mounting Plate
23	31148002	Spacer
25	168506	Brush Carrier Assm.

Powered Nozzle

Models S3131, S3131-030, S3133, S3135, S3137,
S3139, S3139-035, S3141, S3153, S3173

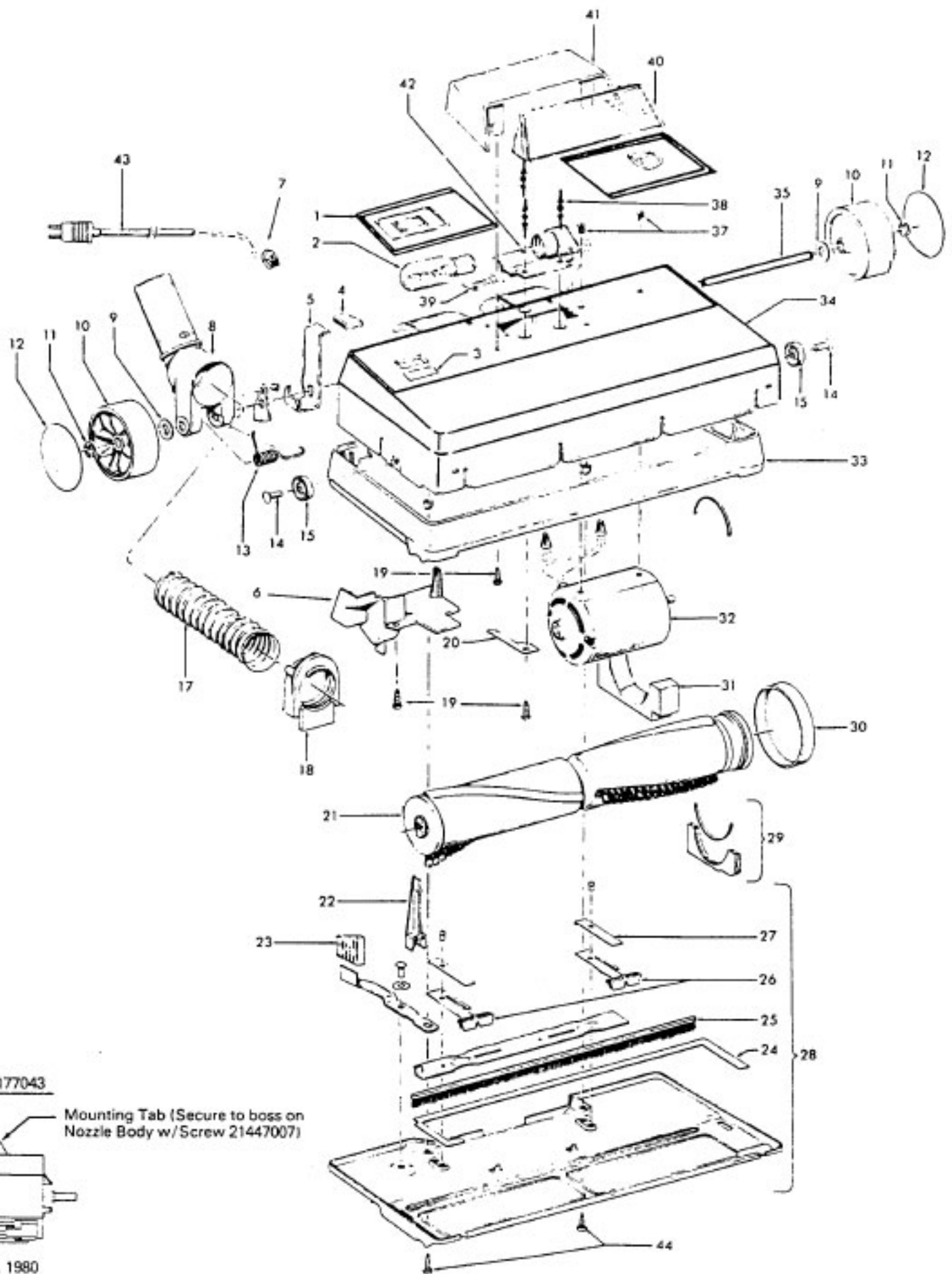

Motor 43177043

Mounting Tab (Secure to boss on
Nozzle Body w/ Screw 21447007)



After Jan. 1980

Powered Nozzle

Ref. No.	Part No.	Description
1	52125021 52125032 51375018	Nameplate - S3131, S3131-030 Nameplate - S3133 Nameplate - S3135, S3139, S3139-035, S3141
	51375027 51375025	Nameplate - S3137 Nameplate - S3139, S3139-035, S3141
	51375026 51375040	Nameplate - S3153 Nameplate - S3173
2	27317307	Lamp - S3139, S3139-035, S3141, S3153
3	39382013	Indicator Lens - S3135, S3137, S3139, S3139-035, S3141, S3153
4	38426072	Foot Pad - JM
5	34664007	Release Lever
6	37943010	Cover
7	163768	Strain Relief
8	43468013	Nozzle
9	31155005	Washer
10	38522001	Wheel
11	13730	Lock Ring
12	169242	Wheel Cover
13	38355005	Torsion Spring
14	21256025	Rivet
15	32761001	Wheel
17	43431196	Hose
18	38638013	Hose Adapter
19	21429404	Screw
20	35412003	Spring
21	48416004	Agitator
22	51151031	Indicator - JM
23	38426080	Foot Pad
24	34123001	Seal
25	48443001	Brush - S3135, S3137, S3139, S3139-035, S3141, S3153
26	36952008	Brush Support
27	34654003	Spring
28	42246007 42246003	Bottom Plate Bottom Plate - S3135, S3137, S3139, S3139-035, S3141, S3153
29	43548001	Agitator Seal
30	38528009	Belt

Models S3131, S3131-030, S3133, S3135, S3137 S3139, S3139-035, S3141, S3153, S3173

Ref. No.	Part No.	Description
31	38781003	Dirt Seal - Prior to Jan. 1980 (Use w/27212011 Motor)
	34284001	Motor Baffle - After Jan. 1980 (Use w/43177073 Motor)
32	27212011	Motor - Prior to Jan. 1980 (Use w/21434224 Screw (2))
	43177073	Motor w/Mounting Tab - After Jan. 1980 (Use w/21447007 Screw (1))
33	36235002	Furniture Guard - JM - S3131, S3131-030, S3135, S3139, S3139- 035, S3141
34	42241041	Nozzle Body - JM
35	32543002	Wheel Shaft
37	21434224	Screw (2) - Prior to Jan. 1980 (Use w/27212011 Motor)
	21447007	Screw (1) - After Jan. 1980 (Use w/43177073 Motor)
38	36218005	Insulation Grommet
39	51638007	Handle Release Label
	51639026	Handle Release Label - S3139, S3139-035, S3141
	51639027	Handle Release Label - S3153
40	39383016	Lens - KC
41	42252001	Housing Assembly
42	27171002	Lamp Socket
43	46321002	Attachment Cord - AG
44	21447003	Screw

ITEMS NOT ILLUSTRATED

46348016	Cord Set - S3131-030
48438011	P.N. Assm. - S3133
48438012	P.N. Assm. - S3131, S3131-030
48438055	P.N. Assm. - S3139, S3139-035, S3141, S3153, S3173
48438014	P.N. Assm. - S3137
48438015	P.N. Assm. - S3135
48438084	P.N. w/o Lens & Nameplate
34618017	Bracket Assm. (Use w/27212011 (Plastic Case) when installing on old style Nozzle Body with two mounting holes.

Models S3057, S3059, S3059-030, S3061, S3061-030, S3077, S3079, S3079-030, S3079-035, S3081, S3083, S3083-030, S3093, S3127, S3131, S3131-030, S3133, S3135, S3137, S3139, S3139-035, S3141, S3147, S3149, S3153, S3161, S3173

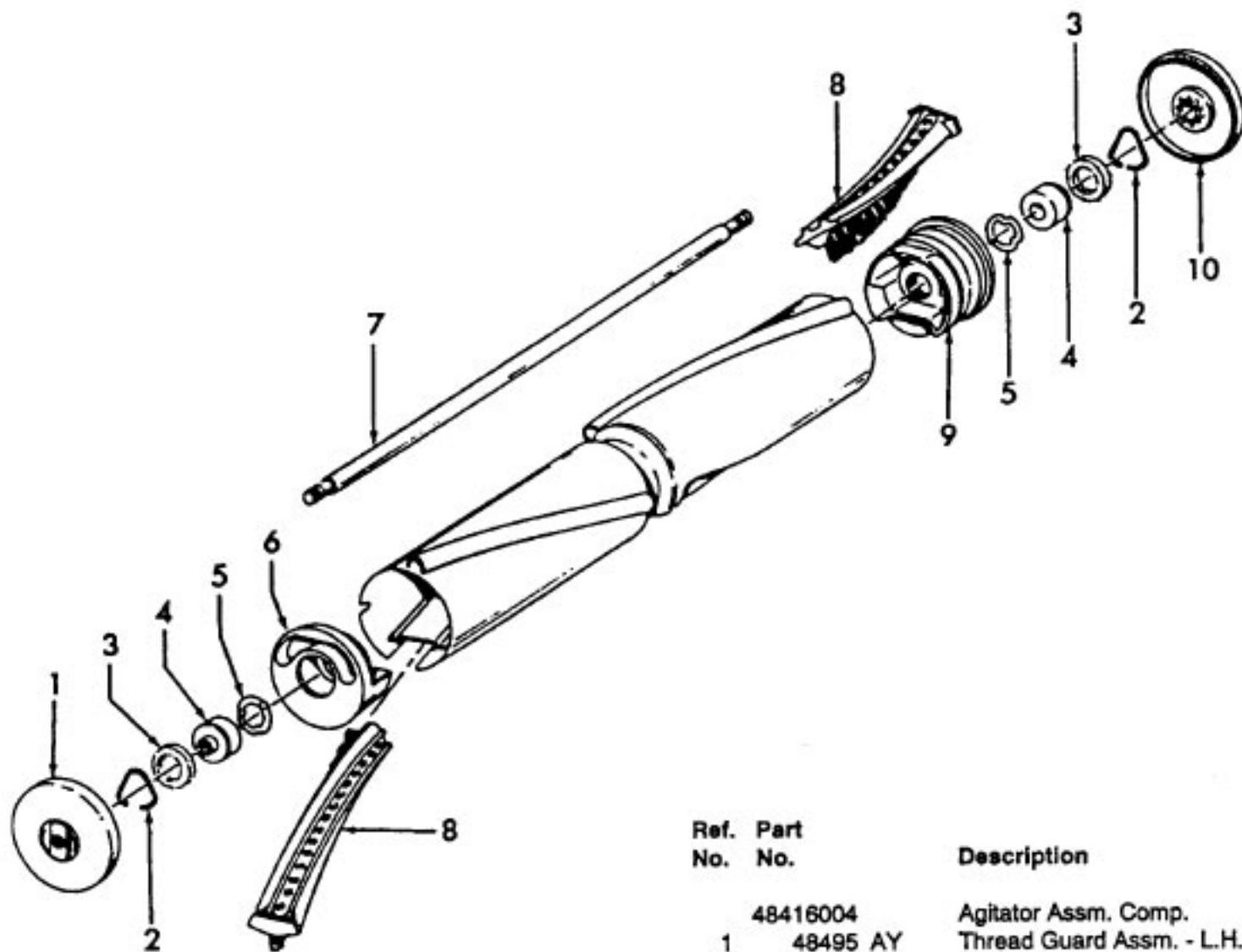
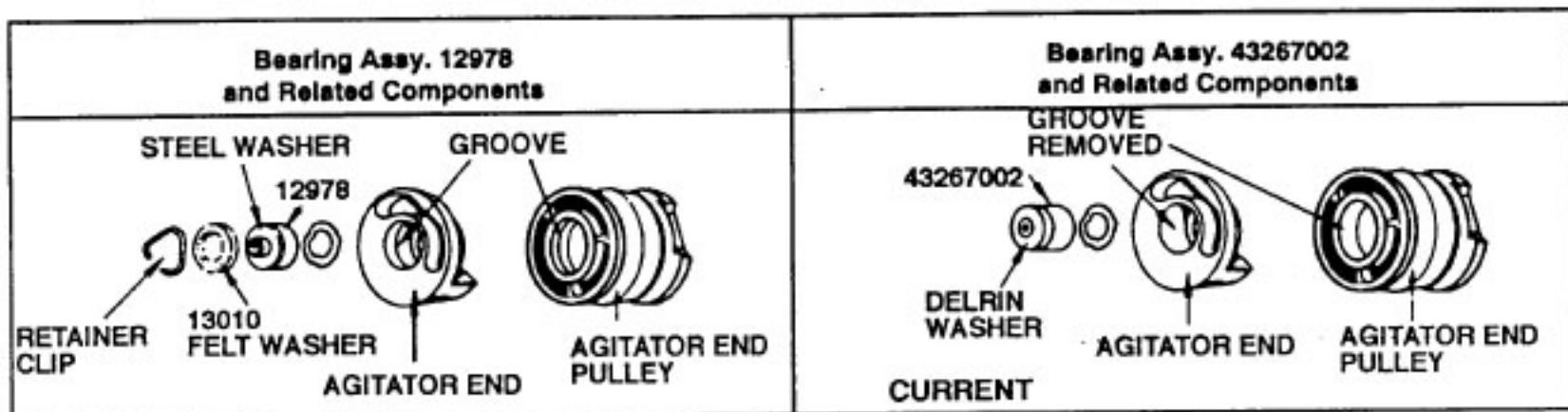

Ref. No.	Part No.	Description
	48416004	Agitator Assm. Comp.
1	48495 AY	Thread Guard Assm. - L.H.
2	12987	Retainer Clip (2)
3	13010	Washer - Felt (2)
4	12978	Agitator Bearing Assm. (2) (Use w/item 2 & 3)
	43267002	Agitator Bearing Assm. (2) (Current)
5	21347003	Washer (2)
6	160542	Agitator End Assm.
7	160070	Agitator Shaft
8	160646 BZ	Agitator Brush Back Assm. (2)
9	160538	Agitator End Pulley
10	12985 AY	Agitator Thread Guard Assm. - R.H.

Cleaning Tools

Models S3131, S3131-030, S3133, S3135, S3137 S3139, S3139-035, S3141, S3153, S3173

Ref. No.	Part No.	Description
1	43434191	Hose - ABX - S3131
	161852JM	Furniture Brush
	43414016	Furniture Brush - AG
3	13077JM	Floor Brush
	43414073	Floor Brush
4	161851JM	Dusting Brush
	43414064	Dusting Brush (One Piece)
5	43414057	Furniture Nozzle
6	38617017	Crevice Tool
7	43453052	Ext. Tube - 20 - AX
	43453088	Ext. Tube (2) (17")
	43453086	Ext. Tube (1) (22")
8	43433085	Current Carrying Hose - AAP
9	13263	Brush (Use w/ 61851 JM)
10	13253AG	Brush
11	13276	Swivel Bushing (2) (Use w/13154JM)
	33712007	Split Ring (Use w/38644040)
12	13154	Swivel Connector (Use w/13077JM)
	38644040	Swivel Connector (Use w/48473025)
14	13149JM	Connector Tube (Use w/161852JM)

Ref. No.	Part No.	Description
15	32855003	Hose Connector
16	12615BZ	Collar
17	32156010	Hose Sleeve
18	43434213	Hose Complete
19	36116006	Collar
20	43466044	Hose Grip - JM
21	38711006	Suction Control Ring
22	51869006	Label
23	36153009	Latch Ring
24	12783	Rivet
25	36171005	Cord Clip
26	12845JM	Gasket
27	13275	Screw
28	13142AG	Suction Control Support
29	13257BZ	Support
30	43468055	Hose Tube (Early) 17"
	43453023	Hose Tube Curved - AX - 20
31	36153009	Latch Ring
32	46321076	Cord Repair Kit

