

This Owner's Manual is provided and hosted by [Appliance Factory Parts](#).

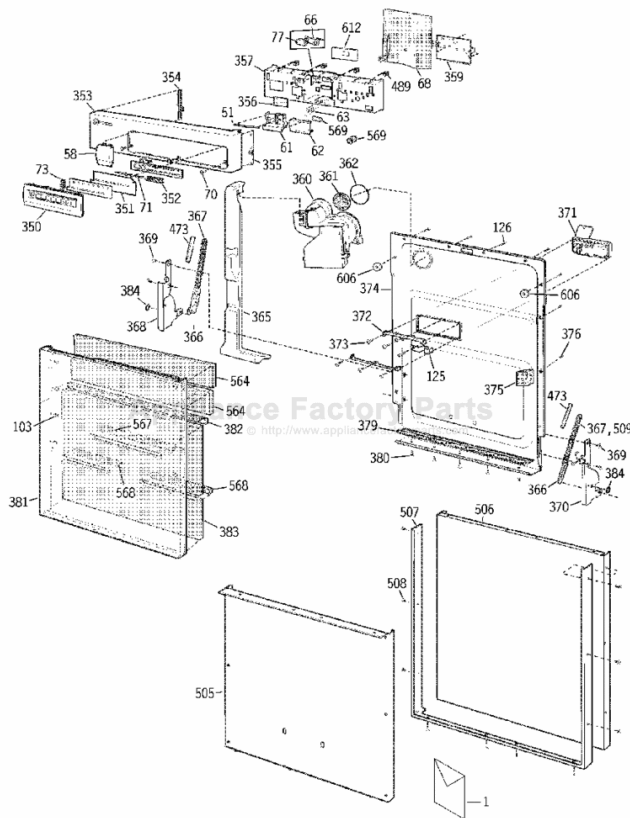

GE ZBD6500G01SS Owner's Manual

[Shop genuine replacement parts for GE
ZBD6500G01SS](#)



[Find Your GE Dishwasher Parts - Select From 6722 Models](#)

----- Manual continues below -----

Owner's Manual

Dishwasher

ZBD6400

ZBD6500

ZBD6600

ZBD6700

ZBD6900

ZBD7000

ZBD7100



Monogram.[®]
We bring good things to life.

Introduction

Your new Monogram dishwasher makes an eloquent statement of style, convenience and kitchen planning flexibility. Whether you chose it for its purity of design, practical features or assiduous attention to detail—or for all of these reasons—you'll find that your Monogram dishwasher's superior blend of form and function will delight you for years to come.

The information on the following pages will help you operate and maintain your dishwasher properly.

If you have any other questions, visit our Website at: www.monogram.com

Contents

Appliance Registration	3, 31, 32	Smart Dry (on some models)	16
Care and Cleaning	20–23	Tone Silencing	16
Consumer Services	3, 28	Auto Memory	16
Model and Serial Number Location	3	Child Lockout Mode	16
Operating Instructions	8–19	Water Temperature	17
Control Panel and settings for		Rinse Agent	17
ZBD6400 and ZBD6500	8, 9	Detergents	17
Control Panel and settings for		Dishwasher Racks	18, 19
ZBD6600	10, 11	Optional Accessories	23
Control Panel and settings for		Problem Solver	24–27
ZBD6700 and ZBD6900	12, 13	Safety Instructions	4–7
Control Panel and settings for		USA Warranty	29
ZBD7000 and ZBD7100	14, 15	Canada Warranty	30
Clean Sensor	16		

Before using your dishwasher

Read this manual carefully. It is intended to help you operate and maintain your new dishwasher properly.

Keep it handy for answers to your questions.

If you don't understand something or need more help, there is a list of toll-free consumer service numbers included in the back section of this manual.

OR

Visit our Website at: www.monogram.com

Write down the model & serial numbers

You can find the model and serial numbers at the inside upper left tub flange.

Before sending in this card, please write these numbers here:

Model Number

Serial Number

Use these numbers in any correspondence or service calls concerning your dishwasher.

If you received a damaged dishwasher

Immediately contact the dealer (or builder) that sold you the dishwasher.

Save time & money

Before you request service, check the Problem Solver in the back of this manual.

It lists causes of minor operating problems that you can correct yourself.

If you need service

To obtain service, see the Consumer Services page in the back of this manual.

We're proud of our service and want you to be pleased. If for some reason you are not happy with the service you receive, here are steps to follow for further help.

For customers in the USA:

FIRST, contact the people who serviced your appliance. Explain why you are not pleased. In most cases, this will solve the problem.

NEXT, if you are still not pleased, write all the details—including your phone number—to:

Manager, Customer Relations
GE Appliances
Appliance Park
Louisville, KY 40225

For customers in Canada:

FIRST, contact the people who serviced your appliance. Explain why you are not pleased. In most cases, this will solve the problem.

NEXT, if you are still not pleased, write all the details—including your phone number—to:

Manager, Consumer Relations
Camco Inc.
1 Factory Lane, Suite 310
Moncton, N.B. E1C 9M3

IMPORTANT SAFETY INSTRUCTIONS MESURES DE SÉCURITÉ IMPORTANTES

▲ **WARNING!**

For your safety, the information in this manual must be followed to minimize the risk of fire, explosion, electric shock, or to prevent property damage, personal injury, or loss of life.

- Do not tamper with controls.
- Do not abuse, sit on, or stand on the door or dish rack of the dishwasher.
- Do not discard a dishwasher without first removing the door or removing the door latch.

- Do not store or use combustible materials, gasoline or other flammable vapors and liquids in the vicinity of this or any other appliance.
- Do not allow children to play inside, on or with this appliance or any discarded appliance.
- Do not allow children to play around the dishwasher when opening and closing the door due to possibility of small fingers being pinched in the door.

▲ **AVERTISSEMENT!**

Pour votre sécurité, veuillez suivre à la lettre les directives données dans le présent manuel afin de réduire les risques d'incendie, d'explosion ou de chocs électriques, et prévenir les dommages matériels et les blessures graves ou mortelles.

- Ne modifiez pas le fonctionnement des commandes.
- Ne montez pas ou ne vous assoyez pas sur la porte ou les paniers du lave-vaisselle, et ne les utilisez pas de façon abusive.
- Ne jetez pas un lave-vaisselle sans en avoir d'abord enlevé la porte ou enlevez le verrou de la porte.

- N'entreposez pas et n'utilisez pas d'essence, de vapeurs ou de liquides inflammables à proximité de cet appareil ou de tout autre électroménager.
- Ne laissez pas les enfants jouer avec le lave-vaisselle ni monter dessus. Ne les laissez pas s'introduire à l'intérieur de cet appareil ou d'un vieil appareil qui ne sert plus.
- Ne permettez jamais à des enfants de jouer à proximité d'un lave-vaisselle quand vous ouvrez ou fermez la porte. Ils peuvent se coincer les doigts dans la porte.

▲ **WARNING! RISK OF CHILD ENTRAPMENT**

PROPER DISPOSAL OF THE DISHWASHER

Junked or abandoned dishwashers are dangerous...even if they will sit for "just a few days." If you are getting rid of your old dishwasher, please follow the instructions below to help prevent accidents.

Before You Throw Away Your Old Dishwasher:

- Take off the door of the washing compartment or remove the door latch keeper (as shown).

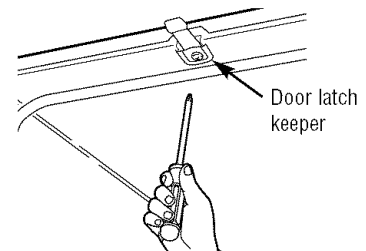

▲ **AVERTISSEMENT! RISQUE D'ENFANT MIS AU PIÈGE**

BONNE DISPOSITION DU LAVE-VAISSELLE

Les machines à laver la vaisselle abandonnée ou jetée sont dangereuses...même si elles sont abandonnées «juste pendant quelques jours». Si vous jetez votre vieux lave-vaisselle, veuillez suivre les instructions suivantes pour prévenir tout accident.

Avant de jeter votre vieux lave-vaisselle :

- Enlevez la porte du compartiment de lavage ou enlevez le réceptacle à verrou (comme l'indique l'illustration).

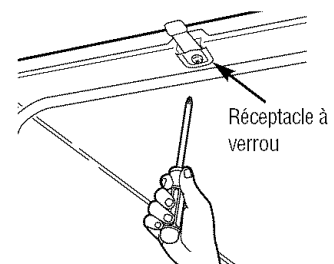

▲ WATER HEATER SAFETY

Under certain conditions hydrogen gas may be produced in a water heater that has not been used for two weeks or more. **HYDROGEN GAS IS EXPLOSIVE.**

If the hot water has not been used for two weeks or more, prevent the possibility of damage or injury by turning on all hot water faucets and allowing them to run for several minutes. Do this before using any electrical appliance which is connected to the hot water system. This simple procedure will allow any built-up hydrogen gas to escape. Since the gas is flammable, do not smoke or use an open flame or appliance during this process.

▲ SÉCURITÉ DU CHAUFFE-EAU

Dans certaines conditions, il peut se former de l'hydrogène à l'intérieur d'un chauffe-eau qui n'a pas servi pendant deux semaines ou plus. **L'HYDROGÈNE EST UN GAZ EXPLOSIF.**

Pour réduire les risques de dommages ou de blessures lorsque l'eau chaude n'a pas été utilisée depuis deux semaines ou plus, ouvrez tous les robinets d'eau chaude et laissez l'eau couler pendant plusieurs minutes avant d'utiliser un appareil électrique raccordé au système d'eau chaude. Vous éliminerez ainsi l'hydrogène qui pourrait s'y être accumulé. Puisqu'il s'agit d'un gaz inflammable, ne fumez pas ou n'utilisez pas une flamme nue au cours de ce processus.

IMPORTANT SAFETY INSTRUCTIONS MESURES DE SÉCURITÉ IMPORTANTES

PROPER INSTALLATION AND MAINTENANCE

This dishwasher must be properly installed and located in accordance with the Installation Instructions before it is used. If you did not receive an Installation Instructions sheet with your dishwasher, you can receive one by visiting our Website at www.monogram.com.

- Connect to a grounded metal, permanent wiring system; or run an equipment-grounding conductor with the circuit conductors and connect to the equipment-grounding terminal or lead of the appliance.
- Improper connection of the equipment-grounding conductor can result in a risk of electric shock. Check with a qualified electrician or service representative if you are in doubt whether the appliance is properly grounded.

- Dispose of discarded appliances and shipping or packing material properly.
- Do not attempt to repair or replace any part of your dishwasher unless it is specifically recommended in this manual. All other servicing should be referred to a qualified technician.
- To minimize the possibility of electric shock, disconnect this appliance from the power supply before attempting any maintenance. **NOTE:** Turning the dishwasher off does not disconnect the appliance from the power supply. We recommend having a qualified technician service your appliance.

INSTALLATION ET ENTRETIEN APPROPRIÉS

Avant de l'utiliser, vous devez installer correctement ce lave-vaisselle conformément aux directives d'installation fournies. Si vous n'avez pas reçu une feuille de directives d'installation avec votre lave-vaisselle, vous pouvez en obtenir un exemplaire par visiter notre site Web à l'adresse www.monogram.com.

- Cet appareil doit être relié à un système de câblage électrique permanent, mis à la terre. Sinon, un fil de mise à la terre pour appareillage doit être installé et raccordé à la borne ou au fil de mise à la terre de l'appareil.
- Un raccordement non approprié du fil de mise à la terre pour appareillage peut présenter des risques de chocs électriques. Si vous doutez de la qualité de la mise à la terre de votre électroménager, consultez un représentant du Service après-vente ou un électricien qualifié.

- Jetez de la façon appropriée les vieux électroménagers, ainsi que le matériel d'emballage et d'expédition.
- Ne tentez pas de réparer ou de remplacer toute pièce de votre lave-vaisselle, à moins que cela ne soit spécifiquement recommandé dans le présent manuel. Confiez toutes les autres réparations à un réparateur qualifié.
- Afin de réduire les risques de chocs électriques, débranchez toujours l'appareil avant de le réparer. **REMARQUE :** Lorsque vous mettez la commande du lave-vaisselle à OFF (arrêt), le courant qui alimente l'appareil n'est pas coupé. Nous vous recommandons de confier la réparation de votre appareil à un réparateur qualifié.

WHEN USING YOUR DISHWASHER

Use this appliance only for its intended purpose as described in this Owner's Manual.

▲ CAUTION: Contents washed in Sanitization cycle may be hot to the touch. Use care before unloading.

- Use only powder, tabs or liquid detergents or wetting agents recommended for use in a dishwasher and keep them out of the reach of children.
- Locate sharp items so that they are not likely to damage the door seal.
- Load sharp knives with the handles up to reduce the risk of cut-type injuries.
- Do not wash plastic items unless marked *dishwasher safe* or the equivalent. For plastic items not so marked, check the manufacturer's recommendations.

- Non-Dishware Items: Do not wash items such as electronic air cleaner filters, furnace filters and paint brushes in your dishwasher. Damage to dishwasher and discoloration or staining of dishwasher may result.
- Do not touch the heating element during or immediately after use.
- Do not operate your dishwasher unless all enclosure panels are properly in place.
- Close supervision is necessary if this appliance is used by or near children.
- Load light plastic items so they will not become dislodged and drop to the bottom of the dishwasher—they might come into contact with the heating element and be damaged.

**READ AND FOLLOW THIS SAFETY INFORMATION CAREFULLY.
SAVE THESE INSTRUCTIONS**

LORSQUE VOUS UTILISEZ VOTRE LAVE-VAISSELLE

N'utilisez ce lave-vaisselle que pour l'usage auquel il est destiné, comme expliqué dans le présent Manuel d'utilisation.

▲ MISE EN GARDE : Les matériaux lavés selon le cycle anti-bactériel peuvent être chauds. Faites attention quand vous videz votre machine.

- N'utilisez que des détergents liquides, en poudre ou en pastilles et les produits de rinçage recommandés pour lave-vaisselle. Gardez tous ces produits hors de portée des enfants.
- Placez les articles aiguisés de manière à ce qu'ils n'endommagent pas le joint de la porte.
- Placez les couteaux les poignées vers le haut afin de réduire les risques de coupures.
- Ne lavez pas d'articles en plastique dans le lave-vaisselle, à moins qu'ils portent la mention *lavable au lave-vaisselle* ou toute mention équivalente. Lorsque les articles de plastique

ne portent aucune mention, lisez les recommandations du fabricant.

- Articles divers : Ne lavez pas des articles comme les filtres à air électroniques, les filtres de fournaise et les pinceaux dans votre lave-vaisselle. Ils pourraient endommager le lave-vaisselle et décolorer ou tacher la cuve.
- Ne touchez pas à l'élément chauffant pendant ou immédiatement après le lavage.
- Ne faites pas fonctionner votre lave-vaisselle lorsque l'un de ses panneaux est enlevé.
- Il faut exercer une étroite surveillance lorsque vous faites fonctionner le lave-vaisselle en présence d'enfants.
- Placez les articles légers en plastique de façon qu'ils ne bougent pas ou ne tombent au fond de l'appareil pendant le lavage. Ils pourraient être endommagés s'ils entrent en contact avec l'élément chauffant.

**VEUILLEZ LIRE ET SUIVRE À LA LETTRE
CES MESURES DE SÉCURITÉ.
CONSERVEZ CES DIRECTIVES**

You can locate your model number on the inside upper tub flange. Throughout this manual, features and appearance may vary from your model.

ZBD6400 & ZBD6500

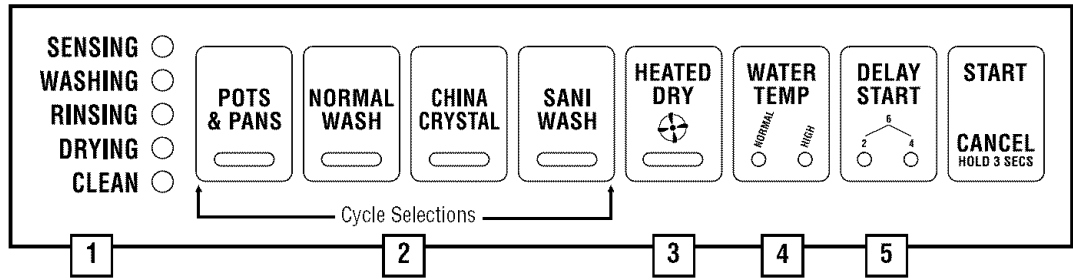

Control Settings

1. Cycle Status Indicators— This display tells you what is happening while the dishwasher is in operation. All of the Cycle Status Indicators will flash on and off if either the door is opened during a cycle or if the cycle has been paused. Your wash is complete when the CLEAN light is illuminated.

SENSING Displayed when the dishwasher is monitoring temperature and water level during fill and drain. Also displayed during periods using CleanSensor technology. CleanSensor measures the amount of soil in the load and decides if a more rigorous wash cycle is required.

WASHING Displayed during the prewash and main wash periods.

RINSING Displayed during rinse periods.

DRYING Displayed during the dry period (if HEATED DRY is selected).

CLEAN Displayed when cycle is complete. Light remains ON until the door is opened.

2. Cycle Selections—The light on the selected pad will illuminate to indicate which cycle has been selected.

POTS & PANS For heavily soiled dishes or cookware with dried-on or baked-on soils. Everyday dishes may be included. This cycle may not remove burned-on foods.

NORMAL WASH For loads of everyday dishes, glasses and cookware with medium soils. **NOTE:** For heavily soiled dishes, choose NORMAL WASH plus HIGH water temperature option.

CHINA CRYSTAL For lightly soiled china and crystal, or recently used, lightly soiled dishes and glassware to be washed in a short time, at moderate temperatures up to 125°F (51°C).

SANI WASH Provides a sanitizing wash and rinse with water temperatures up to 160°F (71°C). The SANI WASH light will remain illuminated at the end of the cycle to indicate that sanitization conditions have been met.



NSF INTERNATIONAL
Meets NSF Standard 184 Sanitization and Cleaning performance of household spray-type dishwashers.

NOTE: NSF certified residential dishwashers are not intended for licensed food establishments.

-
- 3. HEATED DRY**— When selected, turns the drying heater and fan on for fast drying. This option will extend the cycle by 30 minutes. When this is NOT selected, the fan will turn on to dry your dishes without added heat—and energy is saved. HEATED DRY is not available on RINSE ONLY.
- 4. WATER TEMP**— This button provides extra heat options to increase water temperature for optimum performance.
- NORMAL** This is the default setting—provides a wash and rinse with water temperatures up to 131°F (55°C) in the NORMAL cycle and 145°F (63°C) in POTS & PANS.
-
- HIGH** This water temp selection provides a wash and rinse with water temperatures up to 135°F (57°C) in the NORMAL cycle and 155°F (68°C) in POTS & PANS. Use this option for heavily soiled dishes. Cannot be used with RINSE ONLY or CHINA CRYSTAL.
- 5. DELAY START**—This option will allow you to delay the start time of any wash cycle except RINSE ONLY for up to 6 hours.
- Select the delay start time you want by pressing the DELAY START button. Multiple pressing will alternate the delay time between 2, 4 or 6 hours and OFF.
-

Start a wash load

To start the dishwasher, close the door until it locks in place. The last used cycle will be displayed. To begin this cycle, push the START button. To select a different cycle, push the desired Cycle Selection and Option buttons, and then press the START button.

The door must be closed and latched into place to select a cycle or an option.

To interrupt/pause a cycle, press the selected cycle button. The Status Indicators will flash.

▲ CAUTION: Be careful when opening the door; the hot steam that escapes when the door is opened may cause injuries. Stand back as you open the door and allow the steam to escape.

▲ ATTENTION : Faites attention lorsque vous ouvrez la porte. La vapeur brûlante qui s'échappe lorsque vous ouvrez la porte pendant un programme de lavage peut causer des brûlures. Lorsque vous ouvrez la porte, reculez et laissez la vapeur s'échapper de l'appareil.

To restart the wash process, close the door until it locks in place. Re-press the cycle button. There may be a time delay of up to a few minutes, because the temperature inside the dishwasher needs to stabilize before it starts the wash cycle. During this time the SENSING light will be on.

To cancel the cycle after it has started, press and hold the START/CANCEL button for 3 seconds. The dishwasher will then drain and the cycle indicator lights will flash. At this point a new wash cycle can be selected. If a new cycle is not selected, all the Cycle Indicator lights will go out after the dishwasher drains. If you have selected a new wash cycle, remember to add more detergent to the detergent compartment if required.

You can locate your model number on the inside upper tub flange. Throughout this manual, features and appearance may vary from your model.

ZBD6600

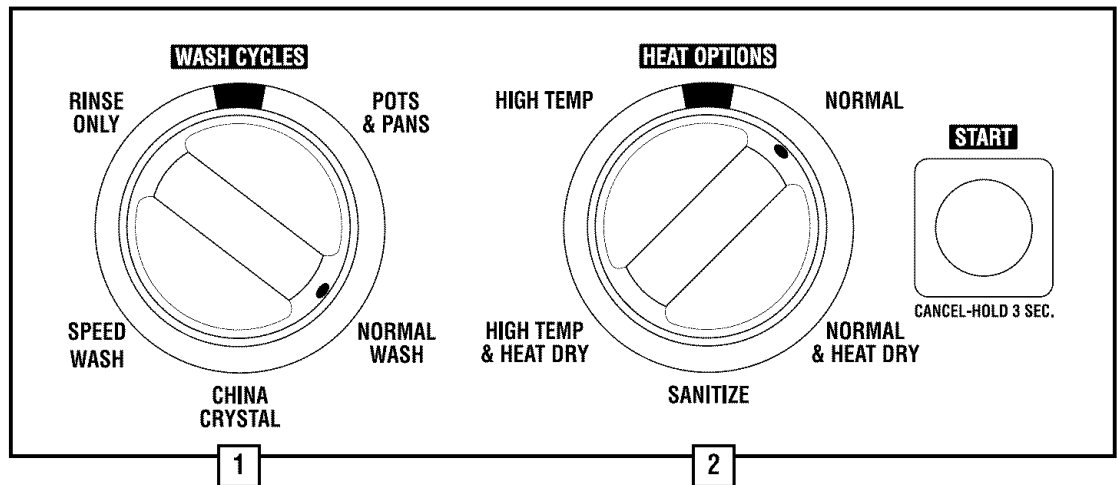

Control Settings

1. WASH CYCLES Knob—Use to select the desired wash cycle based on dishware and soil level.

POTS & PANS	For heavily-soiled dishes or cookware with dried-on or baked-on soils. Everyday dishes may be included. This cycle may not remove burned-on foods.
NORMAL WASH	For loads of everyday dishes, glasses and cookware with medium soils. NOTE: For heavily soiled dishes, choose NORMAL WASH plus HIGH TEMP water temperature option.
CHINA CRYSTAL	For lightly soiled china and crystal, or recently used, lightly soiled dishes and glassware to be washed in a short time at moderate temperatures up to 125°F (51°C).
SPEED WASH	For recently used, lightly soiled dishes and glassware to be washed in a short time. Provides a wash and rinse with water temperatures up to 125°F (51°C).
RINSE ONLY	For rinsing partial loads that will be washed later. Do not use detergent with this cycle.

2. HEAT OPTIONS Knob—Use to select **water temperature** and **drying** options.

NORMAL	Provides a wash and rinse with water temperatures up to 131°F (55°C) in the NORMAL cycle and 145°F (63°C) in POTS & PANS.
HIGH TEMP	Provides a wash and rinse with water temperatures up to 135°F (57°C) in the NORMAL cycle and 155°F (68°C) in POTS & PANS. Not available for SPEED WASH, CHINA CRYSTAL or RINSE ONLY cycles.
SANITIZE	Provides a sanitizing wash and rinse with water temperatures up to 160°F (71°C) in the NORMAL cycle and 171°F (77°C) in POTS & PANS. Not available for SPEED WASH, CHINA CRYSTAL or RINSE ONLY cycles. At the end of the cycle, the HEAT OPTIONS light will illuminate to indicate that the sanitization conditions have been met. The sanitize heat option includes HEAT DRY.



NSF INTERNATIONAL

Meets NSF Standard 184 Sanitization and Cleaning performance of household spray-type dishwashers.

NOTE: NSF certified residential dishwashers are not intended for licensed food establishments.

HEAT DRY	When selected, turns the drying heater on for fast drying. This option will extend the cycle by 30 minutes. When this option is NOT selected, energy is saved. HEAT DRY is not available on RINSE ONLY.
-----------------	---------------------------------------------------------------------------------------------------------------------------------------------------------------------------------------------------------

Start a wash load

To start the dishwasher, close the door until it locks in place. To start the last selected cycle, press the START button. To select a different cycle, turn the knobs to the desired WASH CYCLE and HEAT OPTIONS and press the START button.

NOTE: Not all heat options are available for all cycles. If a combination that is not available is selected, the lights will flash when the START button is pressed and the cycle will not start.

Wash Cycles	HEAT OPTIONS				
	NORMAL	NORMAL & HEAT DRY	HIGH TEMP	HIGH TEMP & HEAT DRY	SANITIZE (INCLUDES HEATED DRY)
POTS & PANS	✓	✓	✓	✓	✓
NORMAL WASH	✓	✓	✓	✓	✓
CHINA CRYSTAL	✓	✓	—	—	—
SPEED WASH	✓	✓	—	—	—
RINSE ONLY	✓	—	—	—	—

To interrupt/pause a cycle gently open the door just enough to turn off the wash motor. Do not fully open the door until the wash action ceases.

⚠ CAUTION: Be careful when opening the door; the hot steam that escapes when the door is opened may cause injuries. Stand back as you open the door and allow the steam to escape.

⚠ ATTENTION : Faites attention lorsque vous ouvrez la porte. La vapeur brûlante qui s'échappe lorsque vous ouvrez la porte pendant un programme de lavage peut causer des brûlures. Lorsque vous ouvrez la porte, reculez et laissez la vapeur s'échapper de l'appareil.

To restart the wash process, close the door until it locks in place. There may be a time delay of up to a few minutes because the temperature inside your dishwasher needs to stabilize before it restarts the wash cycle.

To cancel the cycle after it has started, press and hold the START/CANCEL button for 3 seconds. The dishwasher will start to drain and the cycle indicator lights will flash. At this point a new wash cycle can be selected. If a new cycle is not selected, all the Cycle Indicator lights will go out after the dishwasher drains completely. If you have selected a new wash cycle, remember to add more detergent to the detergent compartment if required.

You can locate your model number on the inside upper tub flange. Throughout this manual, features and appearance may vary from your model.

ZBD6700 & ZBD6900

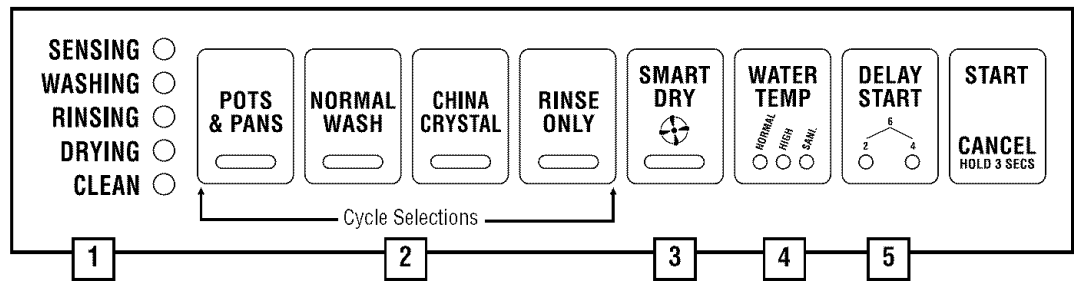

Control Settings

- 1. Cycle Status Indicators—** This display tells you what is happening while the dishwasher is in operation. All of the Cycle Status Indicators will flash on and off if either the door is opened during a cycle or if the cycle has been paused. Your wash is complete when the CLEAN light is illuminated.

SENSING	Displayed when the dishwasher is monitoring temperature and water level during fill and drain. Also displayed during periods using CleanSensor technology. CleanSensor measures the amount of soil in the load and decides if a more rigorous wash cycle is required.
WASHING	Displayed during the prewash and main wash periods.
RINSING	Displayed during rinse periods.
DRYING	Displayed during the dry period (if SMART DRY is selected).
CLEAN	Displayed when cycle is complete. Light remains ON until the door is opened.
- 2. Cycle Selections—** The light on the selected pad will illuminate to indicate which cycle has been selected.

POTS & PANS	For heavily soiled dishes or cookware with dried-on or baked-on soils. Everyday dishes may be included. This cycle may not remove burned-on foods.
NORMAL WASH	For loads of everyday dishes, glasses and cookware with medium soils. NOTE: For heavily soiled dishes, choose NORMAL WASH plus HIGH water temperature option.
CHINA CRYSTAL	For lightly soiled china and crystal, or recently used, lightly soiled dishes and glassware to be washed in a short time, at moderate temperatures up to 125°F (51°C).
RINSE ONLY	For rinsing partial loads that will be washed later. Do not use detergent with this cycle

- 3. SMART DRY**— When selected, sensors detect the presence of rinse aid and the final rinse temperature. The drying heater and fan are then turned on for the minimum time to achieve optimum drying results. This saves energy as compared to conventional heated dry and saves time as compared to non-heated dry. SMART DRY is not available on RINSE ONLY.
-
- 4. WATER TEMP**— This button provides extra heat options to increase water temperature for optimum performance.
- NORMAL** This is the default setting—provides a wash and rinse with water temperatures up to 131°F (55°C) in the NORMAL cycle and 145°F (63°C) in POTS & PANS.
-
- HIGH** This water temp selection provides a wash and rinse with water temperatures up to 135°F (57°C) in the NORMAL cycle and 155°F (68°C) in POTS & PANS. Use this option for heavily soiled dishes. Cannot be used with RINSE ONLY or CHINA CRYSTAL.
-
- SANI** This water temp selection provides a sanitizing wash and rinse with water temperatures up to 160°F (71°C) in the NORMAL cycle and 171°F (77°C) in POTS & PANS. Cannot be used with RINSE ONLY or CHINA CRYSTAL. At the end of the WASH cycle, the SANI OPTION light will remain illuminated to indicate that the sanitization conditions have been met.

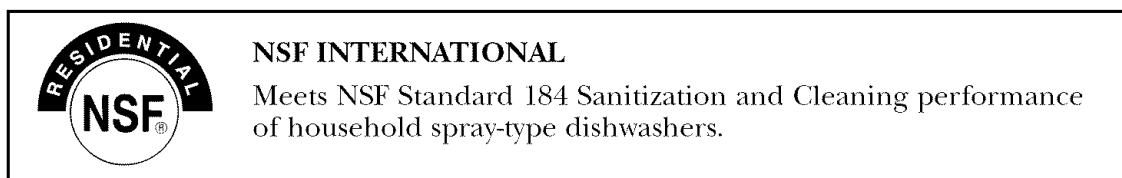

NOTE: NSF certified residential dishwashers are not intended for licensed food establishments.

- 5. DELAY START**—This option will allow you to delay the start time of any wash cycle except RINSE ONLY for up to 6 hours.
- Select the delay start time you want by pressing the DELAY START button. Multiple pressing will alternate the delay time between 2, 4 or 6 hours and OFF.

Start a wash load

To start the dishwasher, close the door until it locks in place. The last used cycle will be displayed. To begin this cycle, push the START button. To select a different cycle, push the desired Cycle Selection and Option buttons, and then press the START button.

The door must be closed and latched into place to select a cycle or an option.

To interrupt/pause a cycle, press the selected cycle button. The Status Indicators will flash.

⚠ CAUTION: Be careful when opening the door; the hot steam that escapes when the door is opened may cause injuries. Stand back as you open the door and allow the steam to escape.

⚠ ATTENTION : Faites attention lorsque vous ouvrez la porte. La vapeur brûlante qui s'échappe lorsque vous ouvrez la porte pendant un programme de lavage peut causer des brûlures. Lorsque vous ouvrez la porte, reculez et laissez la vapeur s'échapper de l'appareil.

To restart the wash process, close the door until it locks in place. Re-press the cycle button. There may be a time delay of up to a few minutes, because the temperature inside the dishwasher needs to stabilize before it restarts the wash cycle. During this time the SENSING light will be on.

To cancel the cycle after it has started, press and hold the START/CANCEL button for 3 seconds. The dishwasher will then drain and the cycle indicator lights will flash. At this point a new wash cycle can be selected. If a new cycle is not selected, all the Cycle Indicator lights will go out after the dishwasher drains. If you have selected a new wash cycle, remember to add more detergent to the detergent compartment if required.

You can locate your model number on the inside upper tub flange.

Throughout this manual, features and appearance may vary from your model.

ZBD7000 & ZBD7100

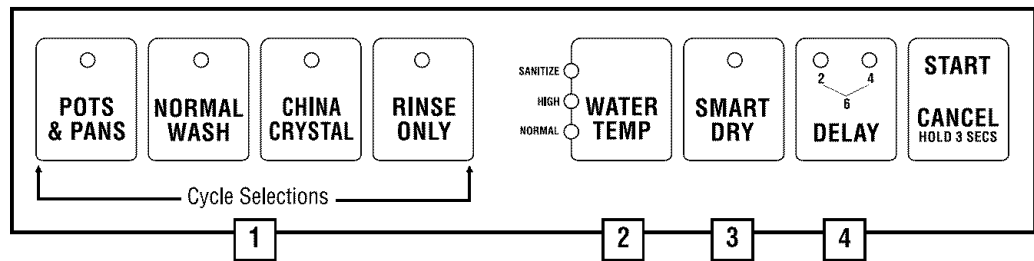

Control Settings

- 1. Cycle Selections**—The light on the selected pad will illuminate to indicate which cycle has been selected.

POTS & PANS	For heavily-soiled dishes or cookware with dried-on or baked-on soils. Everyday dishes may be included. This cycle may not remove burned-on foods.
NORMAL WASH	For loads of everyday dishes, glasses and cookware with medium soils. NOTE: For heavily soiled dishes, choose NORMAL WASH plus HIGH water temperature option.
CHINA CRYSTAL	For lightly soiled china and crystal, or recently used, lightly soiled dishes and glassware to be washed in a short time at moderate temperatures up to 125°F (51°C).
RINSE ONLY	For rinsing partial loads that will be washed later. Do not use detergent with this cycle.

- 2. WATER TEMP**— This button provides extra heat options to increase water temperature for optimum performance.

NORMAL	This is the default setting—provides a wash and rinse with water temperatures up to 131°F (55°C) in the NORMAL cycle and 145°F (63°C) in POTS & PANS.
HIGH	This water temp selection provides a wash and rinse with water temperatures up to 135°F (57°C) in the NORMAL cycle and 155°F (68°C) POTS & PANS.
SANITIZE	This water temp selection provides a sanitizing wash and rinse with water temperatures up to 160°F (71°C) in the NORMAL cycle and 171°F (77°C) in POTS & PANS. This selection cannot be used with RINSE ONLY or CHINA CRYSTAL. At the end of the wash cycle, the SANITIZE OPTION light will remain illuminated to indicate that the sanitization conditions have been met.



NSF INTERNATIONAL

Meets NSF Standard 184 Sanitization and Cleaning performance of household spray-type dishwashers.

NOTE: NSF certified residential dishwashers are not intended for licensed food establishments.

- 3. SMART DRY**—When selected, sensors detect the presence of rinse aid and the final rinse temperature. The drying heater and fan are then turned on for the minimum time to achieve optimum drying results. This saves energy as compared to conventional heated dry and saves time as compared to non-heated dry. SMART DRY is not available on RINSE ONLY.

*Control
Settings*

4. **DELAY START**—This option will allow you to delay the start time of any wash cycle except RINSE ONLY for up to 6 hours.

- Select the delay start time you want by pressing the DELAY START button. Multiple pressing will alternate the delay time between 2, 4 or 6 hours and OFF.
-

*Start a
Wash Load*

To start the dishwasher, open the dishwasher door so that the top-of-door controls are visible. The last used cycle will be displayed. To begin this cycle, press the START button. To select a different cycle, press the desired Cycle Selection and Option buttons, and then press the START button. After the door is closed and latched, the selected cycle will begin.

To interrupt/pause a cycle, gently open the door just enough to turn off the wash motor. Do not fully open the door until the wash action ceases.

⚠ WARNING: Do not fully open door while the dishwasher is in operation. Quickly opening the door while the dishwasher is operating could result in serious scalding. Be careful when opening the door; the hot steam that escapes when the door is opened may cause injuries. Stand back as you open the door and allow the steam to escape.

⚠ AVERTISSEMENT : N'ouvrez pas complètement la porte lorsque la laveuse fonctionne. Une ouverture rapide de la porte lorsque l'appareil est en fonctionnement peut entraîner de sérieuses brûlures. Faites attention lorsque vous ouvrez la porte; la vapeur brûlante qui s'échappe lors de l'ouverture de la porte peut causer des blessures. Tenez vous en arrière lorsque vous ouvrez la porte afin de permettre à la vapeur de s'échapper.

To restart the wash process, close the door until it locks in place. There may be a time delay of up to a few minutes because the temperature inside the dishwasher needs to stabilize before it restarts the wash cycle.

To cancel the cycle after it has started, press and hold the START/CANCEL button for 3 seconds. The dishwasher will then drain and the cycle indicator lights will flash. At this point a new wash cycle can be selected. If a new cycle is not selected, all the Cycle Indicator lights will go out after the dishwasher drains. If you have selected a new wash cycle, remember to add more detergent to the detergent compartment if required.

Clean Sensor

The Clean Sensor monitors the circulating water during the cycles and sets the water temperature and cycle length to match soil levels. Cycle length is automatically increased to handle increasing levels of soil.

Tone Silencing (on some models)

You can prevent the beep from sounding when selecting control settings.

1. Press the START/CANCEL and NORMAL WASH buttons together prior to selecting settings.
2. To have sound again, simply press the START/CANCEL and NORMAL WASH buttons together again.

Auto Memory

Your dishwasher has the ability to remember what options you like with NORMAL WASH and POTS & PANS wash cycle. This means that if you select NORMAL WASH your dishwasher will automatically select the options that you selected last time you washed with the NORMAL WASH cycle. You can change the options that have been remembered with a particular wash cycle if you desire.

Child Lockout Mode (on some models)

To reduce the possibility of children starting the dishwasher when unattended, a child lockout feature can be enabled. Once enabled, each button must be pressed and held for two seconds until you hear a BEEP, before the dishwasher will respond. While in this mode the SENSING and CLEAN light will illuminate while the button is pressed.

This feature can be enabled by pressing both the START/CANCEL and POTS & PANS buttons together and holding both for two seconds. You will hear three BEEPS when the child lockout is enabled.

The child lockout can be cancelled by pressing the START/CANCEL and POTS & PANS together and holding both pressed for two seconds until a single BEEP is heard.

NOTE: Child lockout overrides tone silencing.

Cycle Chart

CYCLES	TEMPERATURE (°F)			WATER USAGE (Gallons)	APPROXIMATE CYCLE TIME* With 120°F Water (excluding drying time)		
	Normal	High	Sani		Normal	High	Sani
POTS AND PANS	145	155	171	6.2–7.4	80	85	102
NORMAL	131	135	160	5.0–11.2	72	75	89
CHINA CRYSTAL	125	—	—	5.0	31	—	—
RINSE ONLY	—	—	—	1.2	11	—	—
SPEED WASH	115–125	—	—	3.8	22	—	—
SANI WASH (on some models)	160	—	—	6.2	89	—	—

*Cycle length will vary based on water temperature option and soil level present.

Detergent Usage Guide (Powder or Liquid)

CYCLES	SOFT WATER 0–3 grains		MEDIUM WATER 3–7 grains		HARD WATER 7–12 grains*	
	Main Cup	Auxiliary Cup	Main Cup	Auxiliary Cup	Main Cup	Auxiliary Cup
POTS & PANS	Full	None	Full	Full	Full	Full
NORMAL WASH	½ Full	None	Full	None	Full	Full
CHINA CRYSTAL	½ Full	None	Full	None	Full	Full
SPEED WASH	½ Full	None	Full	None	Full	Full
RINSE & HOLD	Use no detergent		Use no detergent		Use no detergent	

*12 grains and up is extremely hard water. A water softener is recommended. Without it, lime can build up in the water valve. The water valve may stick and flooding could occur.

NOTE: The above chart is a general guide. Detergent amounts should be adjusted depending on the amount and type of soil until satisfactory results are achieved.

Water Temperature

The entering water must be at least 120°F (49°C) and not more than 150°F (66°C), for effective cleaning and to prevent dish damage. Check the water temperature with a candy or meat thermometer. Turn on the hot water faucet

nearest the dishwasher, place the thermometer in a glass and let the water run continuously into the glass until the temperature stops rising.

Use a Rinse Agent

A rinse agent improves dry performance, reduces spots and prevents new film build-up on your dishes, glasses, flatware, cookware and plastic.

Fill the rinse agent chamber by rotating the round cap counterclockwise and remove. Fill chamber to maximum level. Replace and lock the cap into place.

To check if rinse agent is needed: a solid black indicator indicates sufficient rinse agent; a clear indicator indicates a low level and requires adding more rinse agent.

- A full dispenser should last about one month.

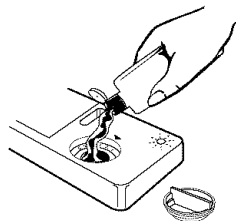

- If rinse agent spills, wipe it up immediately. It can keep your detergent from working.
- If after washing you notice cloudy spots, streaks or water marks on the glassware, and the rinse agent dispenser is not empty, it may be necessary to increase the dispenser settings. To do so, remove the cap and using a butter knife, rotate the indicator arrow to a higher number. Replace the cap when done.
- If glasses appear smeared or there is foam present on the bottom of the glasses or the bottom of the machine, select a lower dosage number.
- For softened water, reduce dispenser setting.

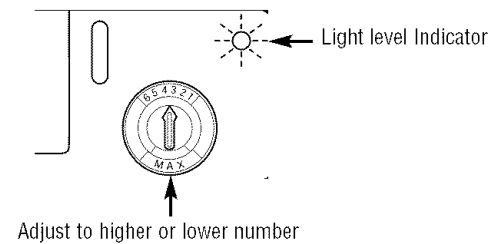

Detergents

Use only detergent specifically made for use in dishwashers. Keep your powdered detergent fresh and dry. Don't put powder detergent into the dispenser until you're ready to wash dishes.

The amount of detergent to use depends on whether your water is hard or soft. With hard water, you need extra detergent. With soft water, you need less detergent.

Protect your dishes and dishwasher by contacting your water department and asking how hard your water is. Twelve or more grains is extremely hard water. A water softener is recommended. Without it, lime can build up in the water valve, which could stick while open and cause flooding. Too much detergent with soft water can cause a permanent cloudiness of glassware, called etching.

To open the detergent compartment, push the lever latch inward.

When using automatic dishwashing detergent tabs, place one tab in the main cup and close.

Be sure the Cycle Status Indicators (on some models) are not lit before adding detergent. Otherwise, the detergent cup will not close and latch properly. Add detergent then close the main cup.

NOTE: To open detergent cup after it has been closed, push the lever latch inward.

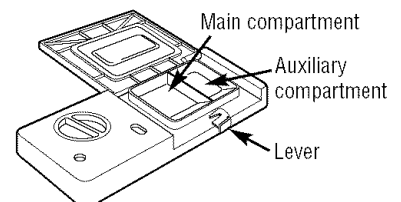

Upper Rack

The upper rack is for glasses, cups, bowls and saucers. Cups and glasses fit best along the sides. This is also a secure place for dishwasher-safe plastics.

The cup shelf may be placed in the up or down position to add flexibility. The cup shelf can also secure wine glasses at an angle for best washability. Because wine glasses come in various sizes, after loading, slowly push in the rack to make sure they will clear the top of the dishwasher.

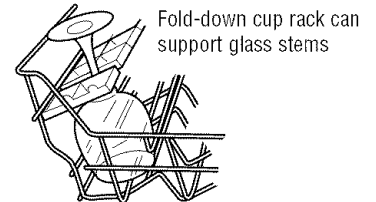
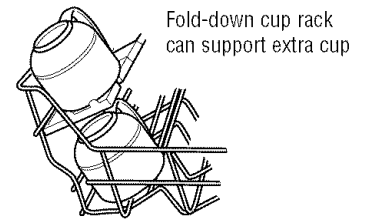

The upper rack is good for all kinds of oddly-shaped utensils. Saucepans, mixing bowls and other items should be placed face down.

Secure larger dishwasher-safe plastic items over two fingers when possible.

Fold-down tines (on some models) provide flexibility for extra-large and hard-to-fit items.

Make sure small plastic items are secure so they can't fall onto the heating element.

Adjusting Upper Rack Height

The upper rack can be raised or lowered to provide extra room for different sized items. Empty the upper rack. Remove the rail pegs in the front of the rack runners by squeezing and lifting the top of the peg, then slide the rack out.

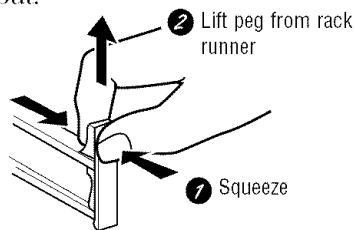

Re-insert the rack in the chosen position and replace the pegs. Check that the spray arm is free to rotate.

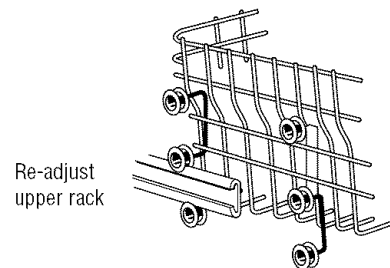

Upper Wash Tower

Take care not to obstruct the rotation of the spray arm under the upper rack or cover the water collector in the center of the upper rack.

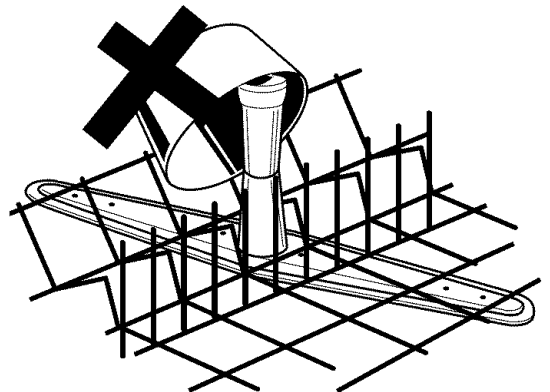

Features and appearance of racks and silverware baskets may vary from your model.

Silverware Basket

Put flatware in the removable basket with fork and knife handles up to protect your hands. Place spoons in the basket with handles down. Mix knives, forks and spoons so they don't nest together. Distribute evenly. Small plastic items, such as measuring spoons and lids from small containers, should go in the bottom of the silverware basket with silverware on top.

Flip-down covers can be lowered to secure lightweight items from the effects of the vigorous wash action. The slots in the covers can be used to separate silverware.

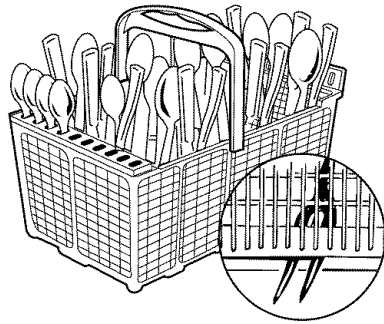

Don't let any item extend through bottom

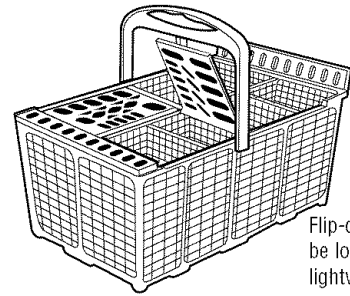

Flip-down covers can be lowered to secure lightweight items

Lower Rack

When loading the lower rack, do not load large platters or trays in the front left corner. They may prevent detergent from circulating during the wash cycle.

The lower rack is best used for plates, saucers, and cookware. Large items such as broiler pans and racks should go along the sides. Load platters, pots and bowls along the sides, in corners, or in the back. The soiled side of items should face the center of the rack.

Fold-down fingers provide flexibility for extra large and hard-to-fit items.

The fingers may be left in the up position or folded down to customize the lower rack.

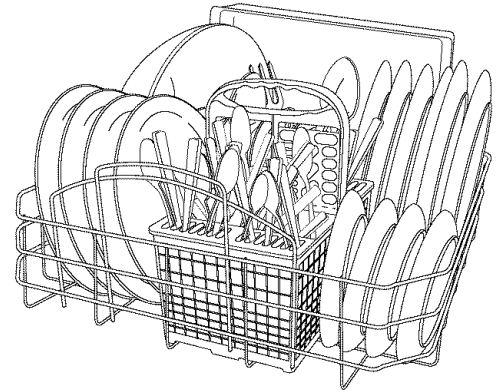

Follow these guidelines for loading 10 place settings

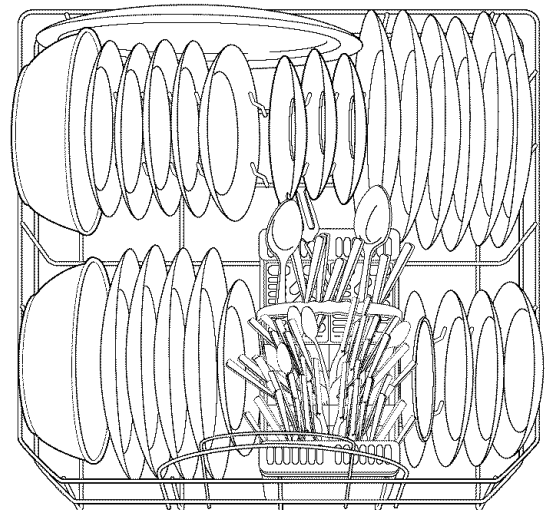
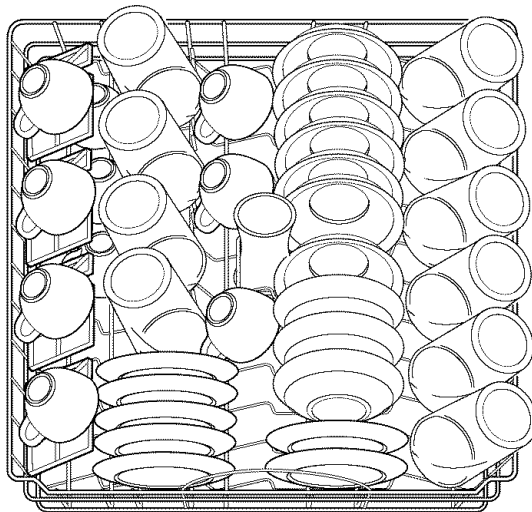

Exterior

To clean the control panel use a lightly dampened cloth then dry thoroughly. To clean the exterior painted panels use a good appliance polish wax.

Never use sharp objects, scouring pads or harsh cleaners on any part of the dishwasher.

Use stainless steel cleaner on stainless steel panel. You can order Stainless Steel Magic # WX10X15 through GE Parts in the USA, by calling 800.626.2002. In Canada, call 1.888.880.3030.

Interior

The stainless steel tub can be cleaned with Stainless Steel Magic or a similar product using a clean, soft cloth.

Use stainless steel cleaner on stainless steel panel. You can order Stainless Steel Magic # WX10X15 through GE Parts in the USA, by calling 800.626.2002. In Canada, call 1.888.880.3030.

Wipe the rubber door seals occasionally, including the seal at the bottom of the door.

Protect Against Freezing

If your dishwasher is left in an unheated place during the winter, ask a service technician to:

1. Cut off electrical power to the dishwasher. Remove fuses or trip circuit breaker.
 2. Turn off the water supply and disconnect the water inlet line from the water valve.
 3. Drain water from the water inlet line and water valve. (Use a pan to catch the water.)
 4. Reconnect the water inlet line to the water valve.
 5. Remove the filters from the tub bottom and use a sponge to soak up water.
-

The Air Gap

An air gap protects your dishwasher against water backing up into it if a drain clogs. The air gap is not a part of the dishwasher. It is not covered by your warranty. Not all plumbing codes require air gaps, so you may not have one.

The air gap is easy to clean.

1. Turn off the dishwasher and lift off the chrome cover.
2. Unscrew the plastic cap and clean with a toothpick.

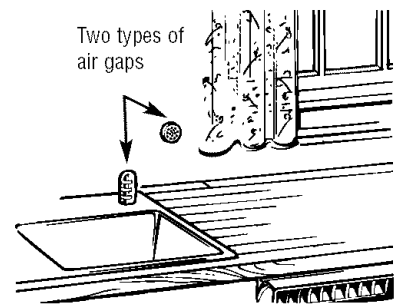

Check the air gap any time your dishwasher isn't draining well.

Removing and Cleaning the Spray Arms and Glass Trap

Periodically, remove and clean the spray arms to make sure that none of the nozzles have become blocked.

To remove the lower spray arm, grasp the center of the spray arm and pull upwards, it will unclip. When replacing, make sure the spray arm is fully seated and spins.

The plastic cone on the underside of the spray arm can be detached by unscrewing it counterclockwise.

To remove the upper spray arm, carefully unscrew the spray arm from the plastic tower. To achieve this, hold the inner tower steady and unscrew the spray arm clockwise. To replace the spray arm, carefully screw the spray arm counterclockwise onto the inner tower.

To clean the upper and lower spray arms, rinse them under running water and make sure spray nozzles are clear.

The glass trap is located in the stainless steel filter at the base of your dishwasher. The glass trap is used to collect larger food items and other foreign objects, which may be too big to pass through the drain pump. For best wash performance, check the glass trap occasionally.

To remove the glass trap, twist counterclockwise, rotate the glass trap and lift. **To clean the glass trap,** empty and rinse thoroughly. **To replace,** reverse these steps making sure the glass trap locks into place.

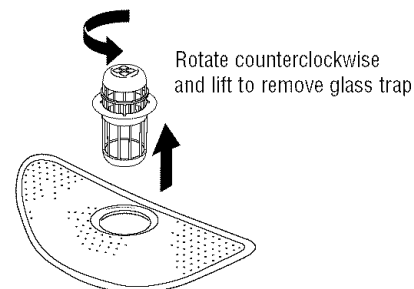
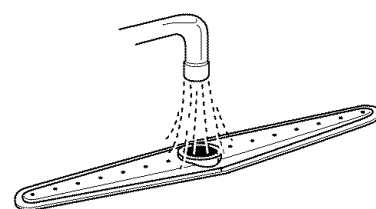
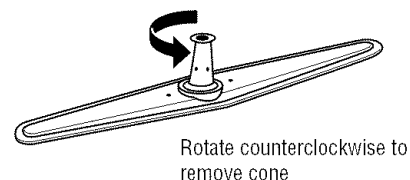
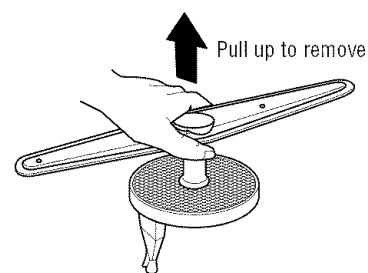

The Wash Filters

In addition to the glass trap, your dishwasher has three fine filters—

- a two piece round perforated stainless steel filter located in the base of the dishwasher.
- a finer micro-mesh filter located under the stainless steel filter.
- a super fine filter located below the lower spray arm.

Remove the stainless steel filter by first twisting and removing the glass trap. Lift out the stainless steel filter.

Attached to the underside of this filter is the micro-mesh filter. **To remove the micro-mesh filter**, squeeze the two clips above the stainless steel filter to release the micro-mesh.

To remove the super fine filter, remove the lower spray arm. Grasp the super fine filter around the outer edges. Remove by pulling upwards, it will unclip. Unscrew the tower counterclockwise. The right half of the stainless steel filter can now be removed.

To clean filters, place under running water and gently brush with a soft bristled brush. Be careful not to deform filters while cleaning, as this may prevent them from being properly re-installed.

The super fine filter is self-cleaning, there is no need to clean it. This filter need only be removed if you want to remove the right half of the stainless steel filter.

Replace your filters in the reverse order, starting with the right half of the stainless steel filter. Then screw in the tower. Replace the super fine filter over the tower by pressing firmly on the outer edge until it clips into place and reposition the lower spray arm. Reconnect the micro-mesh filter to the left half of the stainless steel filter prior to replacing it back into the dishwasher. Then replace the glass trap. Ensure that all filters are replaced correctly for best results.

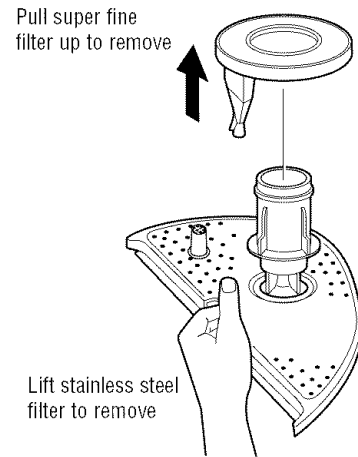
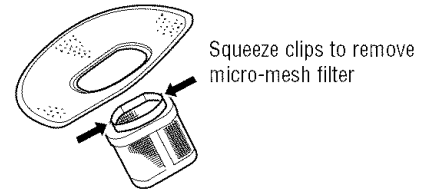
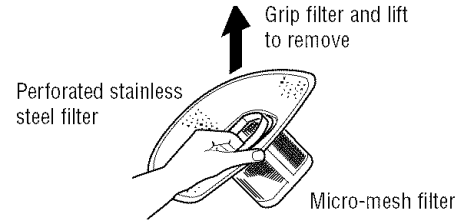

Water Fill Level

For best performance, check the water fill level of your dishwasher.

Once the dishwasher is fully connected, run it through a complete RINSE ONLY cycle to ensure it is emptying and filling correctly. For low water pressure situations run the RINSE ONLY cycle 3 times. Halfway through the final RINSE ONLY cycle, pause the dishwasher and check the water level inside the dishwasher. If the water level is not above the minimum water level (marked on the lower spray support tower), increase the fill level.

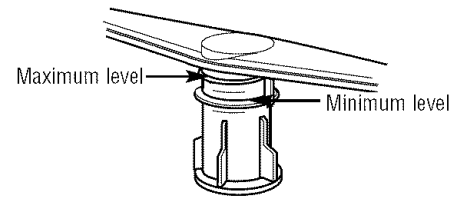

1. Ensure the dishwasher is not running through a cycle. Depress the WATER TEMP button for ten seconds until the second buzzer sounds (except on ZBD6600 models).
2. Press the START/CANCEL button to select fill time, as per chart (65 seconds is the factory setting).
3. To test time, press DELAY START. The dishwasher will start filling. Listen for the dishwasher to complete filling. Once filled, the fill level must be checked to ensure fill time is correct.
4. Once complete, press the WATER TEMP button to exit fill time mode.

Continue to press the START/CANCEL button until the desired indicator is illuminated.

Cycle Status Indicators	Fill time
SENSING	60 seconds
WASHING	65 seconds
RINSING	70 seconds
DRYING	80 seconds
CLEAN	90 seconds

Change the Dishwasher's Appearance for ZBD6400 and ZBD6500 only

You can change the door panel appearance of your dishwasher by ordering one of these optional accessories:

- 1/4" Wood Panel Trim Kit
ZPF625B (Black)
ZPF625W (White)
- 3/4" Trimless Panel Kit
ZPF675B (Black)
ZPF675W (White)

These accessories are available at extra cost by calling in the USA, 800.626.2002. In Canada, call 1.888.880.3030.

Specify accessory number when ordering.

Before You Call For Service

Dishwasher

*Questions?
Use this
problem
solver*

PROBLEM	POSSIBLE CAUSE	WHAT TO DO
Dishwasher will not run	Door not properly closed	<ul style="list-style-type: none"> • Press door until it clicks shut.
	Door is opened during the cycle when the water is hot	<ul style="list-style-type: none"> • Relatch door. Wait a few minutes; dishwasher will restart automatically after the temperature stabilizes.
	Child Lockout mode is selected	<ul style="list-style-type: none"> • Press and hold desired button for two seconds to activate. <p>See Child Lockout Mode Section for more details.</p>
	Fuse is blown, or the circuit breaker tripped	<ul style="list-style-type: none"> • Reset the circuit breaker. • Replace fuse or reset circuit breaker. Remove any other appliances from the circuit.
	Power supply not connected	<ul style="list-style-type: none"> • Check that the dishwasher is plugged in and the switch is on.
Unusual noises	Some of the sounds you will hear are normal: <ul style="list-style-type: none"> • Detergent cup opening. • Water draining out of the tub after touching a keypad or starting a cycle. 	
	Utensils are not secure in the rack or something small has dropped into the rack	<ul style="list-style-type: none"> • Make sure everything is secured in dishwasher.
	Foreign material in the sump	<ul style="list-style-type: none"> • Clean the filters/foreign objects cover.
Detergent left in dispenser cups	Dishes are blocking the detergent cups	<ul style="list-style-type: none"> • Reposition the dishes.
Water will not pump out of the tub	Disposer knock-out plug has not been removed	<ul style="list-style-type: none"> • Remove knock-out plug.
	Drain is clogged	<ul style="list-style-type: none"> • Clean air gap (if applicable). • If the dishwasher drains into a disposer, run disposer to assure it's draining properly. • Check to see if your kitchen sink is draining well. If not, you may need a plumber.

*Questions?
Use this
problem
solver*

PROBLEM	POSSIBLE CAUSE	WHAT TO DO
Suds in the tub	Correct detergent was not used	<ul style="list-style-type: none"> • Use only automatic dishwasher detergents to avoid sudsing. • To remove suds from the tub, open the dishwasher and let suds evaporate. Add 1 gallon of cold water to the tub. <p>For 7000 series models:</p> <ul style="list-style-type: none"> • Pump out water by pressing the NORMAL WASH button; then press the START/CANCEL button. • Close the door until it locks into place. • Wait for one minute; then carefully open the door and hold down the START/CANCEL button for three seconds. <p>For all other models:</p> <ul style="list-style-type: none"> • Pump out water by closing the door until it locks into place. • Press the NORMAL WASH button; then press the START/CANCEL button. • Wait for one minute; then press and hold down the START/CANCEL button for three seconds. Repeat if necessary.
	Too much rinse agent used	<ul style="list-style-type: none"> • Remove any spilled rinse aid. • Reduce rinse aid setting. • For soft water, rinse aid may be unnecessary.
Dishes and flatware not clean	Improper rack loading	<ul style="list-style-type: none"> • Make sure large dishware does not block the detergent dispenser or the wash arm. • Assure silverware is not blocking spray arm.
	Filter or spray arms dirty	<ul style="list-style-type: none"> • Clean filters and spray arms according to instructions on page 22.
	Inlet water temperature is below 120°F	<ul style="list-style-type: none"> • Run tap until water is hot, prior to starting dishwasher cycle. • Raise the water heater temperature to 120°F. • Depending on model, use WATER TEMP HIGH or WATER TEMP SANI option if suitable for dish load.
	Air gap is clogged	<ul style="list-style-type: none"> • Clean the air gap.
	Water pressure is temporarily low	<ul style="list-style-type: none"> • Turn on a faucet. Is water coming out more slowly than usual? If so, wait until pressure is normal before using your dishwasher.

Before You Call For Service

Dishwasher

*Questions?
Use this
problem
solver*

PROBLEM	POSSIBLE CAUSE	WHAT TO DO
Spots and filming on glasses and flatware	Extremely hard water	<ul style="list-style-type: none"> Use a rinse agent to reduce spots and prevent new film buildup.
	Low inlet water temperature	<ul style="list-style-type: none"> To remove stubborn spots on glassware: <ol style="list-style-type: none"> Remove all metal utensils from the dishwasher. Do not add detergent. Select the NORMAL WASH cycle and HEATED DRY option. Start the dishwasher and allow to run until the main wash. Open the door and pour 2 cups (500 ml) of white vinegar into the bottom of the dishwasher. Close the door and allow to complete the cycle. If vinegar rinse doesn't work: Repeat as above, except use 1/4 cup (60 ml) of citric acid crystals instead of vinegar.
	Overloading the dishwasher	
	Improper loading	
	Old or damp powder detergent	
	Rinse agent dispenser empty	
Cloudiness on glassware	Too little detergent	
	Combination of soft water and too much detergent	<ul style="list-style-type: none"> This is called etching and is permanent. To prevent this from happening, use less detergent if you have soft water. Wash glassware in the shortest cycle that will get them clean.
Black or gray marks on dishes	Extended exposure to high-temperature water	<ul style="list-style-type: none"> Lower the water heater temperature to 120°F.
	Aluminum utensils have rubbed against dishes	<ul style="list-style-type: none"> Remove marks with a mild, abrasive cleaner.
Dishes do not dry	HEATED/SMART DRY not selected	<ul style="list-style-type: none"> Depending on Model, select HEATED DRY or SMART DRY.
	Rinse agent dispenser is empty	<ul style="list-style-type: none"> Check the rinse agent dispenser.
	Dishwasher is paused	<ul style="list-style-type: none"> To restart the wash cycle, press the selected wash button.
	Low inlet water	<ul style="list-style-type: none"> Run tap until water is hot prior to starting dishwasher cycle. Assure inlet water temperature is at least 120°F. Depending on your model, select WATER TEMP HIGH and HEATED DRY or WATER TEMP SANI and HEATED DRY options.
Water leaks through door handle	Opening door during cycle without pausing machine first	<ul style="list-style-type: none"> Pause the cycle before opening the door. See page 7.

*Questions?
Use this
problem
solver*

PROBLEM	POSSIBLE CAUSE	WHAT TO DO
Dishwasher won't start	Door not properly closed	<ul style="list-style-type: none"> • Press door until it clicks shut.
	Door opened during cycle when water is hot	<ul style="list-style-type: none"> • Re-latch door. Wait a few minutes. Dishwasher will restart automatically.
	Child Lockout mode is selected	<ul style="list-style-type: none"> • Press and hold desired button for two seconds. See Child Lockout mode section for models ZBD6400, ZBD6500, ZBD6700, ZBD6900, ZBD7000 and ZBD7100.
	Power supply not connected	<ul style="list-style-type: none"> • Check dishwasher is plugged in and switch is on.
All cycle status indicators flashing or beeping every 30 seconds (on ZBD6400, ZBD6500, ZBD6700, ZBD6900, ZBD7000 and ZBD7100)	Door not properly closed	<ul style="list-style-type: none"> • Press door until it clicks shut.
	Dishwasher is paused	<ul style="list-style-type: none"> • To restart the wash cycle, press the selected wash button.
Motor starts but water doesn't enter dishwasher (flashing CHINA CRYSTAL or LIGHT WASH light) (on models ZBD6400, ZBD6500, ZBD6700, ZBD6900, ZBD7000 and ZBD7100)	Water supply valve turned off	<ul style="list-style-type: none"> • Open water supply valve.
Program taking too long or not advancing properly	Low inlet water temperature	<ul style="list-style-type: none"> • Run tap until water is hot prior to starting dishwasher cycle. • Allow time to heat water (up to one hour). • Check inlet water temperature. • Connect to hot water supply.
Water does not empty out of dishwasher (flashing RINSE ONLY or SANI WASH light) (on models ZBD6400, ZBD6500, ZBD6700, ZBD6900, ZBD7000 and ZBD7100)	Outlet blocked	<ul style="list-style-type: none"> • Check garbage disposal and air gap for blockage. • Check outlet hose for kinks and sharp bends.
Dishwasher continues to drain indefinitely	Faulty fill valve	<ul style="list-style-type: none"> • First, turn off water supply valve; then turn off circuit breaker and call for service.
Yellow color on dishes and glassware	Water has iron or other mineral content	<ul style="list-style-type: none"> • A special filter in the water supply line is the only way to correct this problem. Contact a water softener company.
White film on glasses, tea, and coffee stains	Hard water	<ul style="list-style-type: none"> • Try progressively increasing the Rinse Aid setting to 6. See the Rinse Agent section.
	Repeated use of SANI	<ul style="list-style-type: none"> • Discontinue use of SANI option.
Brown spots or pitting of stainless steel and tarnishing of silver	Consistently low water level in dishwasher	<ul style="list-style-type: none"> • Check operating water level is between the MIN. and MAX. indicators on lower spray arm support tower. See Care and Cleaning section.
	Electrolysis following contact with other metals	<ul style="list-style-type: none"> • Wash scratched or worn pieces by hand. Polish silverware with a silver-plate cleaner.
	Detergent thrown over the cutlery or saucepans	<ul style="list-style-type: none"> • Load detergent properly. See Using the Dishwasher section.
Light goes out		<ul style="list-style-type: none"> • Call for service.

With the purchase of your new Monogram appliance, receive the assurance that if you ever need information or assistance from GE, we'll be there. All you have to do is call—toll-free!

GE Answer Center®

***In the USA:
800.626.2000***

Whatever your question about any Monogram major appliance, GE Answer Center® information service is available to help. Your call—and your question—will be answered promptly and courteously. And you can call any time. GE Answer Center® service is open 24 hours a day, 7 days a week.

OR

Visit our Website at: www.monogram.com

In Canada, call 1.888.880.3030.

In-Home Repair Service

***In the USA:
800.444.1845***

***In Canada:
1.888.880.3030***

A GE consumer service professional will provide expert repair service, scheduled at a time that's convenient for you. Many GE Consumer Service company-operated locations offer you service today or tomorrow, or at your convenience (7:00 a.m. to 7:00 p.m. weekdays, 9:00 a.m. to 2:00 p.m. Saturdays). Our factory-trained technicians know your appliance inside and out—so most repairs can be handled in just one visit.

For Customers With Special Needs...

***In the USA:
800.626.2000***

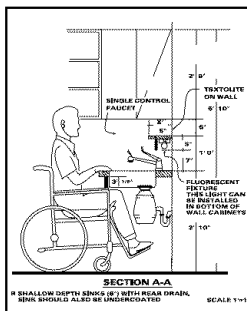

GE offers Braille controls for a variety of GE appliances, and a brochure to assist in planning a barrier-free kitchen for persons with limited mobility.

Consumers with impaired hearing or speech who have access to a TDD or a conventional teletypewriter may call 800.TDD.GEAC (800.833.4322) to request information or service.

Service Contracts

***In the USA:
800.626.2224***

***In Canada:
1.888.880.3030***

You can have the secure feeling that GE Consumer Service will still be there after your warranty expires. Purchase a GE contract while your warranty is still in effect and you'll receive a substantial discount. With a multiple-year contract, you're assured of future service at today's prices.

Parts and Accessories

***In the USA:
800.626.2002***

***In Canada:
1.888.880.3030***

Individuals qualified to service their own appliances can have parts or accessories sent directly to their home. The GE parts system provides access to over 47,000 parts...and all GE Genuine Renewal Parts are fully warranted.

User maintenance instructions contained in this manual cover procedures intended to be performed by any user. Other servicing generally should be referred to qualified service personnel. Caution must be exercised, since improper servicing may cause unsafe operation.

YOUR MONOGRAM DISHWASHER WARRANTY

Staple sales slip or cancelled check here. Proof of original purchase date is needed to obtain service under warranty.

WHAT IS COVERED

From the Date of the Original Purchase

ONE-YEAR

Any part of the dishwasher which fails due to a defect in materials or workmanship. During this full one-year warranty, GE will also provide, free of charge, all labor and in-home service to replace the defective part.

Second Year

Any part of the dishwasher which fails due to a defect in materials or workmanship. During this second-year limited warranty, you will be responsible for any labor or in-home service costs.

Five Years

The dishwasher rack, if it should rust, or the electronic control module, if it should fail due to a defect in materials or workmanship. During this five-year limited warranty, you will be responsible for any labor or in-home service costs.

Lifetime

The stainless steel tub or door liner, if it fails to contain water due to a defect in materials or workmanship. During this full lifetime warranty, GE will also provide, free of charge, all labor and in-home service to replace the defective part.



This warranty is extended to the original purchaser and any succeeding owner for products purchased for ordinary home use in the 48 mainland states, Alaska, Hawaii and Washington, D.C. Proof of original purchase date is needed to obtain service under the warranty.

All warranty service will be provided by our Factory Service Centers or by our authorized Customer Care® servicers during normal working hours.

Should your appliance need service, during warranty period or beyond, call 800.444.1845.

WHAT IS NOT COVERED

- Service trips to your home to teach you how to use the product.
- Improper installation, delivery or maintenance.
- Replacement of house fuses or resetting of circuit breakers.
- Failure of the product if it is abused, misused, or used for other than the intended purpose or used commercially.
- Damage to the product caused by accident, fire, floods or acts of God.
- Incidental or consequential damage caused by possible defects with this appliance.
- Cleaning or servicing of the air gap device in the drain line.
- Damage after delivery.

Some states do not allow the exclusion or limitation of incidental or consequential damages, so the above limitation or exclusion may not apply to you. This warranty gives you specific legal rights, and you may also have other rights which vary from state to state. To know what your legal rights are in your state, consult your local or state consumer affairs office or your state's Attorney General.

Warrantor: General Electric Company, Louisville, KY 40225.

YOUR MONOGRAM DISHWASHER WARRANTY

Staple sales slip or cancelled check here. Proof of original purchase date is needed to obtain service under warranty.

WHAT IS COVERED

From the Date of the Original Purchase

ONE-YEAR

Any part of the dishwasher which fails due to a defect in materials or workmanship. During this full one-year warranty, GE will also provide, free of charge, all labor and in-home service to replace the defective part.

Second Year

Any part of the dishwasher which fails due to a defect in materials or workmanship. During this second-year limited warranty, you will be responsible for any labor or in-home service costs.

Five Years

The dishwasher rack, if it should rust, or the electronic control module, if it should fail due to a defect in materials or workmanship. During this five-year limited warranty, you will be responsible for any labor or in-home service costs.

Lifetime

The stainless steel tub or door liner, if it fails to contain water due to a defect in materials or workmanship. During this full lifetime warranty, GE will also provide, free of charge, all labor and in-home service to replace the defective part.

.....
This warranty is extended to the original purchaser and any succeeding owner for products purchased for ordinary home use in Canada. Proof of original purchase date is needed to obtain service under the warranty.

All warranty service will be provided by our Factory Service Centers or by our authorized Customer Care® servicers during normal working hours.

Should your appliance need service, during warranty period or beyond, call 1.888.880.3030.

WHAT IS NOT COVERED

- Service trips to your home to teach you how to use the product.
- Improper installation, delivery or maintenance.
- Replacement of house fuses or resetting of circuit breakers.
- Failure of the product if it is abused, misused, or used for other than the intended purpose or used commercially.
- Damage to the product caused by accident, fire, floods or acts of God.
- Incidental or consequential damage caused by possible defects with this appliance.
- Cleaning or servicing of the air gap device in the drain line.
- Damage after delivery.

Some provinces do not allow the exclusion or limitation of incidental or consequential damages, so the above limitation or exclusion may not apply to you. This warranty gives you specific legal rights, and you may also have other rights which vary from province to province. To know what your legal rights are in your province, consult your local or provincial consumer affairs office.

Warrantor: Camco Inc., 1 Factory Lane, Suite 310, Moncton, N.B. E1C 9M3.

**Consumer Product
Ownership Registration
Important Mail Today**

GE Appliances



Place
1st Class
Letter
Stamp
Here

General Electric Company
Warranty Registration Department
P.O. Box 32150
Louisville, KY 40232-2150

Consumer Product Ownership Registration

Dear Customer:

Thank you for purchasing our product and thank you for placing your confidence in us. We are proud to have you as a customer!

Follow these three steps to protect your new appliance investment:

1 Complete and mail your Consumer Product Ownership Registration today. Have the peace of mind of knowing we can contact you in the unlikely event of a safety modification.

2 After completing this registration, write your model and serial numbers in this manual. You will need this information should you require service. The service number in the USA: 800.444.1845. In Canada: 1.888.880.3030.

3 Read your "Owner's Manual" carefully. It will help you operate your new appliance properly.

Important: To ensure that your product is registered, mail the separate product registration card. If the separate product registration card is missing, fold and mail the form below. No envelope is needed.

FOLD HERE

Consumer Product Ownership Registration



Product
Dishwasher

Model

Serial

Mr. Ms. Mrs. Miss

First Name _____ Last Name _____

Street Address _____

Apt. # _____

City _____ State _____ Zip Code _____

Date Placed In Use Month _____ Day _____ Year _____ Phone Number _____-_____-_____



www.monogram.com



TAPE CLOSED



Monogram.
We bring good things to life.

General Electric Company
Louisville, KY 40225

165D4700P230
49-5904-2

0616400326 01-03 JR
Printed in Australia