

USER'S GUIDE

Welcome	1
Safety Instructions.....	2
Controls At A Glance.....	3-5
Special Features.....	6
Operating Tips	7
Care and Cleaning	8
Storing the Washer	8
Water Use.....	8
Before You Call	9-10
Warranty.....	Back Page

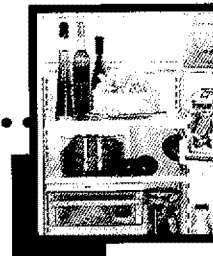

KEEP THESE INSTRUCTIONS FOR FUTURE REFERENCE

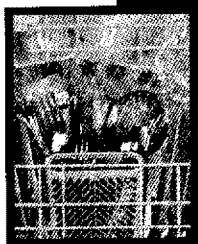
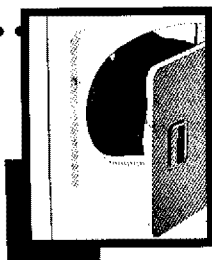
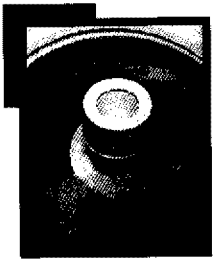

Model: LAT9806

Welcome.....



Welcome and congratulations on your purchase of a Consumer Rated No.1 Maytag Washer! Your complete satisfaction is very important to us.

Read this manual for best results. It contains instructions to acquaint you with proper operating and maintenance procedures.

In addition you will find a *Laundering Tips* guide packed with your washer. It contains information on recommended laundering procedures, stain removal and special laundering situations.



Save time and money. If something should go wrong, we suggest consulting the "Before You Call" section in the back of this book. It is designed to help you solve basic problems before consulting a servicer.

However, should you need assistance, it is helpful to:

1) Have complete model and serial number identification of your washer. This is located on a data plate on the top edge of the control panel. Record these numbers below for easy access.

Model Number

Serial Number

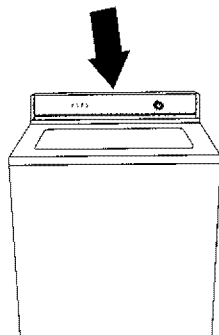

2) Have proof of original date of purchase.

Please attach your sales receipt here.

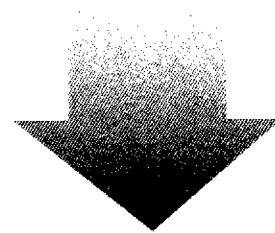

For additional questions, please contact us:

Maytag Consumer Information
One Dependability Square
Newton, Iowa 50208
(515) 791-8911
(Mon.-Fri., 8am-5pm Central Time)
Internet: <http://www.maytag.com>

For service and warranty information, see back page.

NOTE: In our continuing effort to improve the quality of our appliances, it may be necessary to make changes to the appliance without revising this guide.

Important Safety Instructions

⚠ WARNING — To reduce the risk of fire, explosion, electric shock, property damage or injury to persons when using your appliance, follow basic precautions, including the following:

1. Read all instructions before using the appliance.
2. As with any equipment using electricity and having moving parts, there are potential hazards. To use this appliance safely, the operator should become familiar with the instructions for operation of the appliance and always exercise care when using it.
3. Do not install or store this appliance where it will be exposed to the weather.
4. Install and level washer on a floor that can support the weight.
5. This appliance must be properly grounded. Never plug the appliance cord into a receptacle which is not grounded adequately and in accordance with local and national codes. See installation instructions for grounding this appliance.
6. To avoid the possibility of fire or explosion:
 - a. Do not wash items that have been previously cleaned in, washed in, soaked in, or spotted with gasoline, dry-cleaning solvents, other flammable or explosive substances as they give off vapors that could ignite or explode. Hand wash and line dry any items containing these substances.

Any material on which you have used a cleaning solvent, or which is saturated with flammable liquids or solids, should not be placed in the washer until all traces of these liquids or solids and their fumes have been removed.

These items include acetone, denatured alcohol, gasoline, kerosene, some liquid household cleaners, some spot removers, turpentine, waxes and wax removers.
 - b. Do not add gasoline, dry-cleaning solvents, or other flammable or explosive substances to the wash water. These substances give off vapors that could ignite or explode.
 - c. Under certain conditions, hydrogen gas may be produced in a hot water system that has not been used for 2 weeks or more. **HYDROGEN GAS IS EXPLOSIVE.** If the hot water system has not been used for such a period, before using a washing machine or combination washer-dryer, turn on all hot water faucets and let the water flow from each for several minutes. This will release any accumulated hydrogen gas. As the gas is flammable, do not smoke or use an open flame during this time.
7. Do not reach into the appliance if the agitator is moving.
8. Do not allow children to play on or in the appliance. Close supervision of children is necessary when the appliance is used near children.
9. Do not tamper with controls.
10. Do not repair or replace any part of the appliance or attempt any servicing unless specifically recommended in published user-repair instructions that you understand and have the skills to carry out.
11. Unplug power supply cord before attempting to service your washer.
12. The agitator should not be removed. If the agitator is removed, it must be replaced by pushing down completely and the locking screw tightened before the washer is operated.
13. Store laundry aids and other material in a cool, dry place where children cannot reach them.
14. Do not wash or dry items that are soiled with vegetable or cooking oil. These items may contain some oil after laundering. Due to the remaining oil, the fabric may smoke or catch fire by itself.
15. Do not use chlorine bleach and ammonia or acids (such as vinegar or rust remover) in the same wash. Hazardous fumes can form.
16. Do not machine wash fiberglass materials. Small particles can stick to fabrics washed in following loads and cause skin irritation.
17. Before the appliance is removed from service or discarded, remove the door to the washing compartment.

Save These Instructions

Controls At A Glance

Step 1 Select Cycle

Press the control knob in and turn clockwise to the desired cycle. Pull the knob out to start the washer.

DOUBLE WASH – provides excellent cleaning even with very heavily soiled items. Detergent is placed in the bottom of the tub and *liquid* detergent in the gray detergent cup on the top of the agitator. (See page 6 for detailed information.)

REGULAR/DELICATE cycles share the same portion of the control knob. For regular fabrics, select a cycle and press a **REGULAR WASH/SPIN SPEED** button. For delicate fabrics, select a cycle and press a **DELICATE WASH/SPIN SPEED** button. (See page 5 for detailed information.) Cycles available:

HEAVY – approximately 13-15 minutes of wash time

NORMAL – approximately 10-12 minutes of wash time

LIGHT/QUICK – approximately 7-9 minutes of wash time

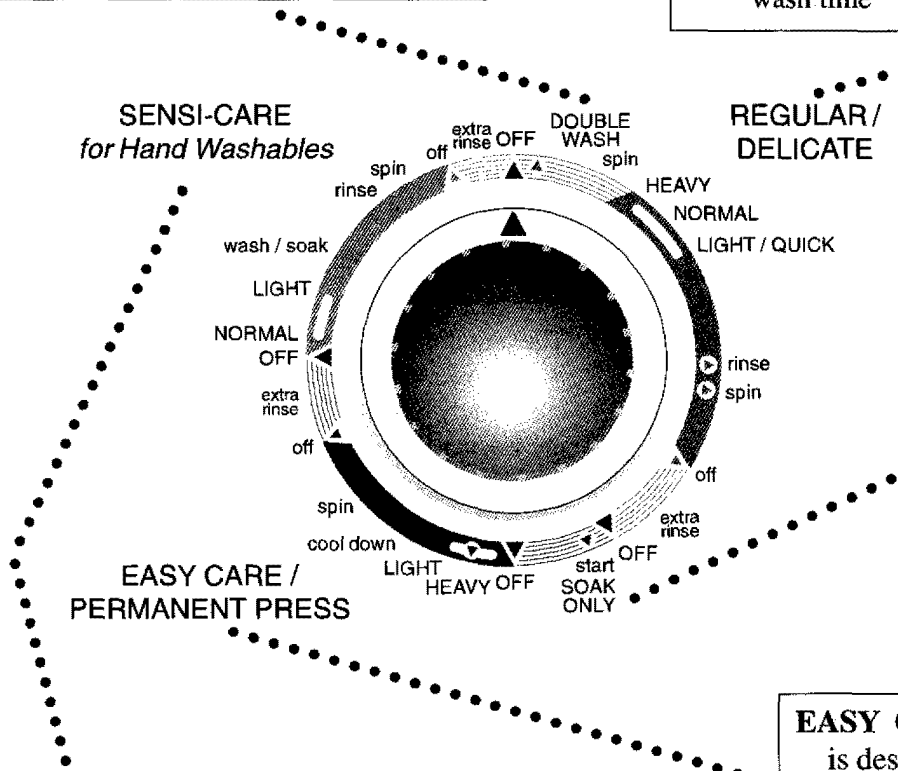

SOAK ONLY – soaks heavily-soiled or stained items as desired. The user then advances the control knob into a wash cycle or spin and drain. (Overnight soaking is not recommended.)

SENSI-CARE for Hand Washables is designed for items labeled “hand washable.” The washer alternates between periods of delicate wash and soak. Cycles available:

NORMAL – approximately 10 minutes of wash time

LIGHT – approximately 6 minutes of wash time

EASY CARE/PERMANENT PRESS is designed to minimize wrinkles with a cool-down spray rinse following the wash. Cycles available:

HEAVY – approximately 10-14 minutes of wash time

▼ **(NORMAL)** – approximately 7-9 minutes of wash time

LIGHT – approximately 5-6 minutes of wash time

Step 2 Select Water Level

Simply move the infinite slide lever up or down to the desired setting or any point in between. If more water is needed once the fill is complete, move the lever up to **reset** and then to the proper setting.

WATER LEVEL SETTING	LOAD SIZE
Super	3/4 – Full
Large	1/2 – 3/4 Full
Medium	1/3 – 1/2 Full
Small	1/3 Full
Mini	1/4 Full

REMEMBER: Items must circulate freely for best results.

INFINITE WATER LEVEL

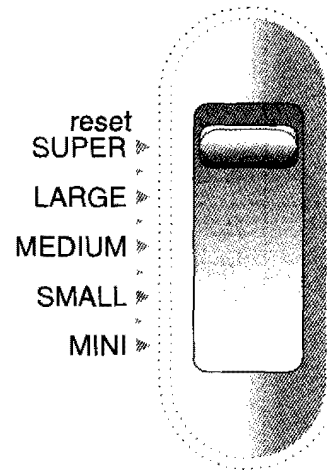

Step 3 Select Water Temperature

Press the appropriate button to select the wash and rinse temperatures. Follow the garment care label for best results. Use the chart below as a guide.

WASH/RINSE TEMPS	LOAD TYPE
Hot/Cold	White and heavily soiled, color-fast items
Warm/Warm	Delicate items
Warm/Cold	Moderately soiled, colored items; most Easy Care/Permanent Press items
Cold/Cold	Brightly colored, lightly soiled items; washable woolens

REMEMBER: In wash water temperatures below 65° F, detergents do not dissolve well or clean well. Care labels define cold water as up to 85° F.

WASH / RINSE TEMP

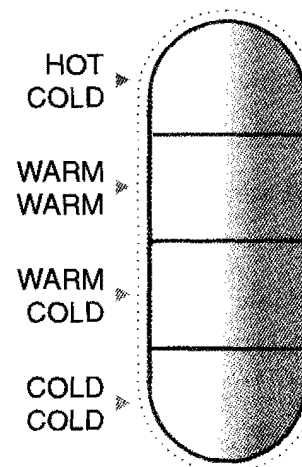

Step 4 Select Options (if desired)

Press the appropriate button(s) to select one or more options.

OPTION	USE
Extra Rinse	Provides additional rinse at the end of the cycle to more completely remove laundry additives, suds, perfumes, etc.
Extra Spin	Removes more water from absorbent loads like bath towels. (Not available with SENSI-CARE cycle.)
Energy Saver	Restricts hot water use to save water heating costs. Select WASH/RINSE TEMP desired, plus press Energy Saver button.
Cancel Options	Press button to cancel and reset any of the above options.

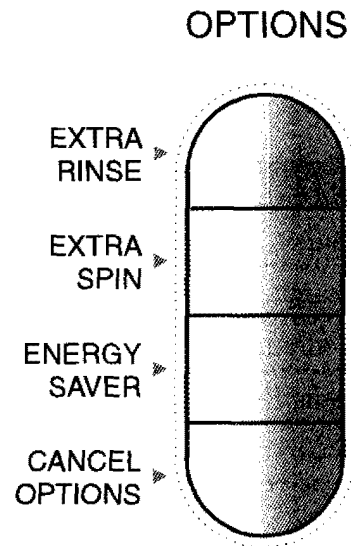

Step 5 Select Wash/Spin Speeds

Press the appropriate button to select the wash and spin speeds to fit the fabric type.

WASH/SPIN SPEED	DESIGNED FOR
Regular/Fast	Sturdy fabrics needing maximum water extraction
Regular/Slow	Sturdy fabrics needing slower spin speed because of wrinkling
Delicate/Fast	Delicate fabrics needing maximum water extraction
Delicate/Slow	Delicate fabrics needing slower spin speed because of construction

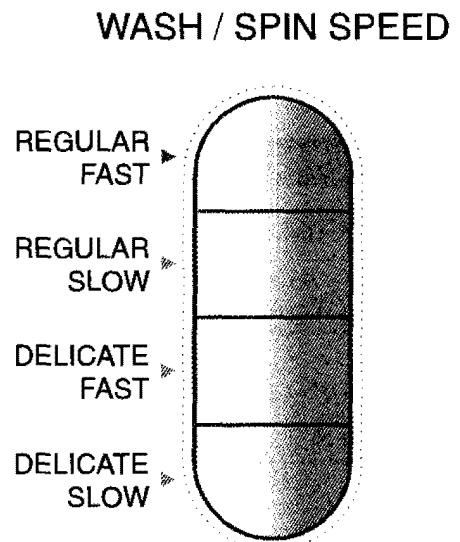

Step 6 Start Washer

- Add detergent.
- Add load and close lid.
- Pull out control knob to start.



Special Features

Indicator Lights

- **SOAK** – lights during a soak cycle.
- **WASH/RINSE** – lights to indicate the washer is in a wash or rinse portion of the cycle.
- **ON** – lights whenever the washer is running.

Bleach Dispenser

The dispenser automatically dilutes liquid chlorine bleach before it reaches your wash load. To use, follow these steps:

1. Measure liquid chlorine bleach carefully, following the instructions on the bottle.
2. Add the bleach to the dispenser before adding the load. Avoid splashing or over-filling the dispenser.

NOTE:

- Never pour undiluted liquid chlorine bleach directly onto the load or into the wash tub. It is a powerful chemical and can cause fabric damage, such as tearing or color loss, if not used properly.
- If you prefer to use color-safe, non-chlorine bleach, pour it into the wash tub with your detergent. Do not pour non-chlorine bleaches into the bleach dispenser.

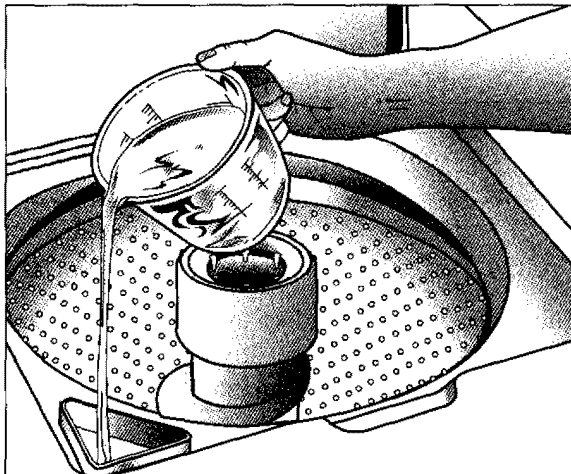

Pour liquid chlorine bleach into bleach dispenser.

Fabric Softener Dispenser

This dispenser automatically releases liquid fabric softener at the proper time during the cycle. To use, follow these steps:

1. Pour liquid fabric softener into the dispenser using the amount recommended on the package.
2. Add warm water to the dispenser until it reaches the MAX line.
3. Do not use fabric softener with a double wash cycle.

NOTE:

- Do not stop the washer during the first spin. This will cause the dispenser to empty too soon.
- Never pour fabric softener directly on the load. It will leave spots and stains.
- Use the dispenser for liquid fabric softeners only. Clean the area in and around the dispenser frequently with hot water, detergent and a soft brush.

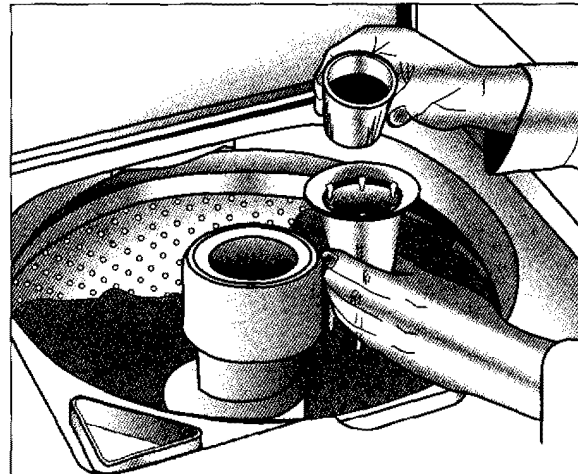

Pour liquid fabric softener into cup and dilute with warm water.

Double Wash Detergent Dispenser

You will find a second gray colored dispenser cup packed with your washer. Liquid detergent is poured into this cup for a Double Wash cycle. It is placed in the top of the agitator. The detergent will automatically be dispensed during the second wash as fresh water enters the tub.

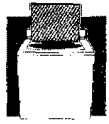

Operating Tips

For detailed information on sorting, pretreating stains, etc., see the enclosed Laundry Tips pamphlet.

Detergent

- Use either liquid or granular laundry detergent. **For best results, be sure detergent is added to the washer BEFORE the load and be sure wash water is above 65° F.**
- Use the correct amount of detergent for the load size, soil level and water conditions. Use more detergent if you have hard water and very soiled loads.

If you have soft water or a lightly soiled load, use less detergent. (See manufacturer's instructions.)

- Wipe up any detergent spills on the washer.

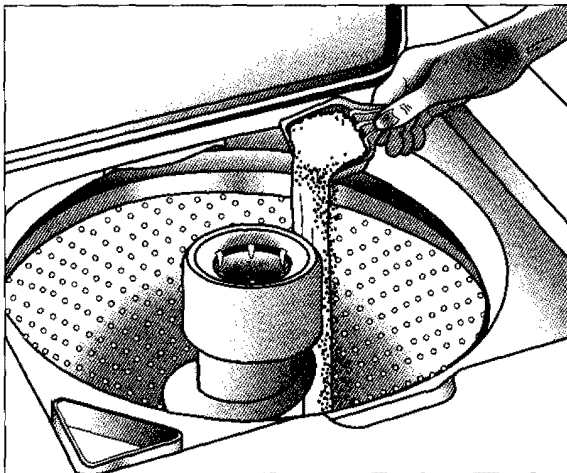

Loading

- Put dry, unfolded clothes loosely in the tub, up to the top row of holes for a maximum load.
- Do not wrap large items like sheets around the agitator.
- Mix large and small items for best circulation. Wash bulky items like blankets separately.
- When laundering permanent press items or items of delicate construction, washable woolens or loosely knit items, never use less than the **MEDIUM** water level setting. This will minimize shrinkage, wrinkling and pulling of seams.
- For best results, add the detergent to washtub before adding the load.

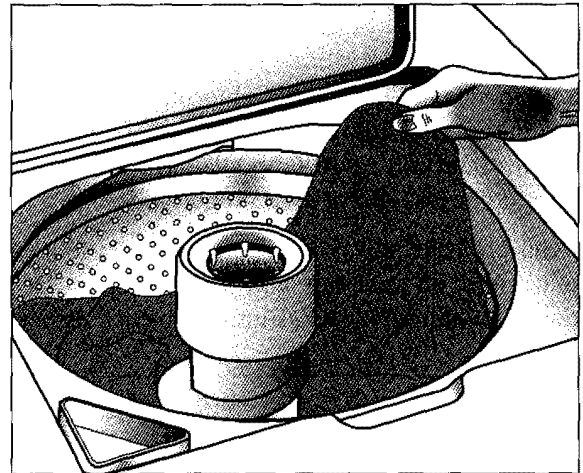

Additional Tips

- If the washer stops during the spin, it may be due to an unevenly distributed load. If this happens, push in the control knob, open the lid, redistribute the load, close the lid and pull out the control knob. The spin will resume at the point it was interrupted.
- The washer will pause briefly throughout each cycle. These pauses are normal.
- This washer is designed so that it will not agitate or spin when the lid is open. It will, however, fill with the lid open so water is available for pretreating stains or diluting fabric softener.
- If you open the lid during a cycle, the washer will stop. When the lid is closed and the control knob pulled out, the washer will continue the cycle at the point it was interrupted.



Care and Cleaning

Turn off the water faucets after finishing the day's washing. This will shut off the water supply to the washer and prevent the unlikely possibility of damage from escaping water.

Use a soft cloth to wipe up all detergent, bleach or other spills as they occur.

Clean the following as recommended:

Control Panel – clean with a soft, damp cloth and glass cleaner. Do not use abrasive powders or cleaning pads.

Cabinet – clean with soap and water followed with an appliance wax, if desired.

Interior – hard water deposits may be removed, if needed, using a recommended cleaner labeled washer safe.

Lint Filter – these are self-cleaning and require no maintenance. They are located under the agitator on the bottom of the washtub. During the wash and rinse portion of the cycle, lint is collected on the filters. Then during the spin and drain the filters are cleaned automatically.

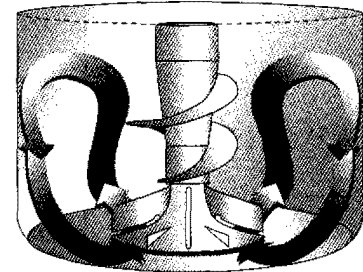

Storing the Washer

Washers can be damaged if water is not removed from hoses and internal components before storage. Prepare the washer for storage as follows:

- Select the NORMAL cycle for regular fabrics and add one cup of bleach or white vinegar to a full load of water without clothes. Run the washer through a complete cycle.
- Turn the water faucets off and disconnect the inlet hoses.

- Advance the cycle control knob to Spin and lower the drain hose to eliminate any water that may be in the drain hose.
- Disconnect the washer from the electrical supply and leave the washer lid open to let air circulate inside the tub.



Water Use

REGULAR CYCLE

Super	Approx. 40 gallons (33 Imperial gallons; 151 liters)
Large	Approx. 36 gallons (30 Imperial gallons; 136 liters)
Medium	Approx. 32 gallons (27 Imperial gallons; 121 liters)
Small	Approx. 28 gallons (23 Imperial gallons; 106 liters)
Mini	Approx. 24 gallons (20 Imperial gallons; 91 liters)

PERMANENT PRESS CYCLE

Super	Approx. 43 gallons (36 Imperial gallons; 163 liters)
Large	Approx. 39 gallons (32 Imperial gallons; 148 liters)
Medium	Approx. 35 gallons (29 Imperial gallons; 132 liters)
Small	Approx. 31 gallons (26 Imperial gallons; 117 liters)
Mini	Approx. 27 gallons (22 Imperial gallons; 102 liters)



Before You Call.....

For problem laundry solutions (i.e. fabric damage, residue, tangling) and special laundry care procedures, see the enclosed Laundry Tips pamphlet.

Check these points if your washer...

Won't Fill

- Plug cord into live electrical outlet.
- Check fuse or reset circuit breaker.
- Turn the control knob to proper cycle and pull knob out to start the washer. If equipped with buttons, be sure they are fully depressed.
- Turn both faucets on fully.
- Straighten inlet hoses.
- Disconnect hoses and clean screens. Hose filter screens may be plugged.

Won't Agitate

- Check fuse or reset circuit breaker.
- Turn the control knob to proper cycle and pull knob out to start the washer. If equipped with buttons, be sure they are fully depressed.
- Close lid and pull knob out to start the washer. For your safety, washer will not agitate or spin unless the lid is closed.
- The washer is equipped with a lid switch failure detector. If the lid switch should malfunction, the detector will stop operations for your safety. Call for service.

Won't Spin or Drain

- Unevenly distributed load. Redistribute the load, close the lid and pull knob out. Check for leveling. Be sure water level is acceptable for load size.
- Check fuse or reset circuit breaker.
- Straighten drain hoses. Eliminate kinked hoses. If there is a drain restriction, call for service.
- Close lid and pull knob out to start the washer. For your safety, washer will not agitate or spin unless the lid is closed.
- Suds lock – caused by too much suds. Rewash without detergent. Use correct amount of a low-sudsing detergent.
- The washer is equipped with a lid switch failure detector. If the lid switch should malfunction, the detector will stop operations for your safety. Call for service.

Check these points if your washer...

Stops

- Unevenly distributed load. Redistribute the load, close the lid and pull knob out. Check for leveling. Be sure water level is acceptable for load size.
- Plug cord into live electrical outlet.
- Check fuse or reset circuit breaker.
- Turn the control knob to proper cycle and pull knob out to start the washer. If equipped with buttons, be sure they are fully depressed.
- Close lid and pull knob out to start the washer. For your safety, washer will not agitate or spin unless lid is closed.
- This may be a pause or soak period in the cycle. Wait briefly and it may start.
- The washer is equipped with a lid switch failure detector. If the lid switch should malfunction, the detector will stop fill operations for your safety. Call for service.

Leaks Water

- Make sure hose connections are tight.
- Make sure end of drain hose is correctly inserted and secured to drain facility.
- Avoid extended soaking – soak for 30 minutes or less.
- Avoid overloading.

Is Noisy

- Be sure washer is leveled properly as outlined in installation manual.
- Weak floors can cause vibration and walking.
- Be sure rubber feet are installed on leveling legs.

Fills with the Wrong Temperature Water

- Turn both faucets on fully.
- If equipped with a temperature selector knob, be sure it is set directly on a temperature setting and not between settings.
- Make sure temperature selection is correct.
- Make sure hoses are connected to correct faucets and inlet connections. Be sure water supply is regulated correctly. Flush water line before filling washer.
- Check the water heater. It should be set to deliver a minimum 120°F (49°C) hot water at the tap. Also check water heater capacity and recovery rate.
- Disconnect hoses and clean screens. Hose filter screens may be plugged.

Cycle Selector Knob Advances Through "OFF"

- Extra rinse option is selected

For further help, call Maytag Customer Assistance: U.S. 1-800-688-9900 or Canada 1-800-688-2002



Automatic Washer Warranty.....

Full One Year Warranty

For one (1) year from the date of original retail purchase, any part which fails in normal home use will be repaired or replaced free of charge.

Limited Parts Warranty

After the first year from the date of original retail purchase through the time periods listed below, the designated parts which fail in normal home use will be repaired or replaced free of charge for the part itself, with the owner paying all other costs, including labor.

Second Year – All parts.

Third through Fifth Year – The drive motor. All parts of the solid state controls (if so equipped).

Third through Tenth Year – All parts of the transmission assembly.

Additional Limited Warranty Against Rust

Should an exterior cabinet, including the top, lid, and baseframe, rust during the five year period starting from the date of original retail purchase, repair or replacement will be made free of charge during the first year. After the first and through the fifth year, repair or replacement will be made free of charge for the part itself, with the owner paying all other costs, including labor.

This full warranty and the limited warranties apply when the appliance is located in the United States or Canada. Appliances located elsewhere are covered by the limited warranties only, which include parts which fail during the first year.

To Receive Warranty Service

To locate an authorized service company in your area, contact the Maytag dealer from whom your appliance was purchased or call Maytag Customer Service. Should you not receive satisfactory warranty service, call or write:

Maytag Customer Assistance
c/o Maytag Customer Service
P.O. Box 2370
Cleveland, TN 37320-2370
US **1-800-688-9900**
CANADA **1-800-688-2002**

When contacting Maytag Customer Service be sure to provide the model and serial numbers of your appliance, the name and address of the dealer from whom you purchased the appliance and the date of purchase.

This Warranty gives you specific legal rights, and you may also have other rights which vary from state to state.

Should you still have a problem, write to: Major Appliance Consumer Action Program (MACAP), 20 North Wacker Drive, Chicago, Illinois 60606, MACAP is an industry sponsored but independent group of consumer experts who receive and act on complaints from appliance owners.

NOTE: When writing about an unsolved service problem, please include the following information:

- (a) Your name, address and telephone number;
- (b) Model number and serial numbers (found on top edge of control panel) of your appliance;
- (c) Name and address of your dealer and date the appliance was bought;
- (d) A clear description of the problem you are having;
- (e) Water hardness, detergent brand and amount, water temperature and cycle used.

MAYTAG • One Dependability Square • Newton, Iowa 50208