

This Owner's Manual is provided and hosted by [Appliance Factory Parts](#).

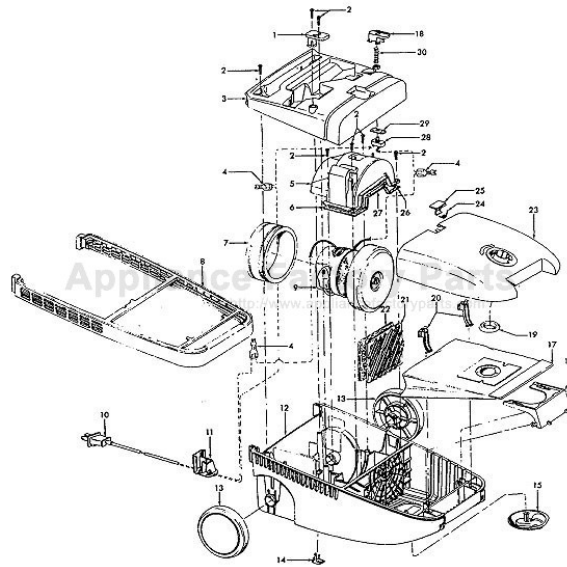

HOOVER S3511 Owner's Manual

[Shop genuine replacement parts for HOOVER S3511](#)



[Find Your HOOVER Vacuum Cleaner Parts - Select From 1456 Models](#)

----- Manual continues below part list -----

Available Replacement Parts for HOOVER S3511

H-4010064S	BAG OEM HOOVER (3 PACK)
H-43414073	Floor brush.
H-43414064	DUSTING BRUSH (ONE PEICE)
H-38765009	SECONDARY FILTER
HR-5000	EXTENSION TUBE

Futura
TurboPOWER 2000
PowerMax

Models S3509, S3511, S3519, S3523, S3527
Model S3547
Model S3510

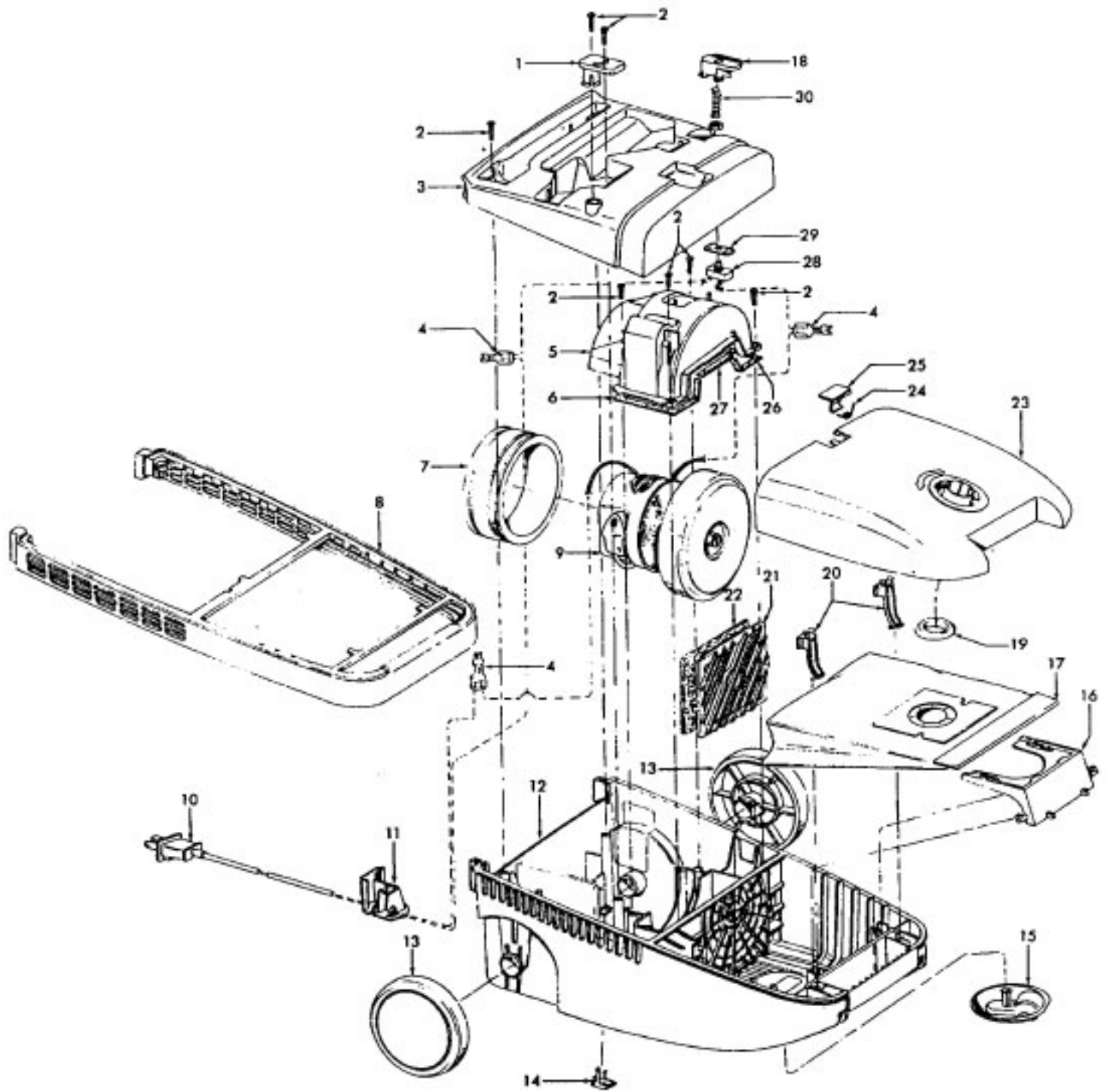

**Futura
TurboPOWER 2000
PowerMax**

**Models S3509, S3511, S3519, S3523, S3527
Model S3547
Model S3510**

Ref. No.	Part No.	Description
1	39442034	Cord Wrap - AG
2	21447217	Screw (7)
3	Note: Motor Cover Assembly's include item 1	
	41426098	Motor Cover Assem. - AAS - S3509
	41426100	Motor Cover Assem. - ABC - S3511
	41426076	Motor Cover Assem. - ABB - S3519
	41426115	Motor Cover Assem. - ACA - S3523
	41426116	Motor Cover Assem. - ABB - S3527, S3510
	41426119	Motor Cover Assem. - AG - S3547
4	12227	Insulated Terminal (3)
	27618508	Wire Connector
5	41312040	Motor Retainer Assem. - AAP (incl. Items 6,26,27)
6	34633003	Retainer Seal - RH
7	36322031	Motor Mount - BZ
8	36235069	Furniture Guard - AG
9	43576184	Motor Assem. - S3509, S3511, S3510 (7.3 Amps) (P-266)
	43576114	Motor Assem. - (P-250)
	43576126	Motor Assem. - S3509, S3511 (7.9 Amps) (P-267) - S3509, S3511, S3519 (7.8 Amps)
	43576186	Motor Assem. Comp. - S3523, S3527, S3547 (P-290)
10	46383273	Attachment Cord - AAP
	46383289	Attach. Cord - AG - S3510, S3523, S3527, S3547
11	36215033	Strain Relief - ABU
	36215034	Strain Relief - AG - S3547
12	42215051	Main Body Assem. - ABU - S3510, S3523, S3527 (incl. Items 8, 13, 14, 15)
	42215052	Main Body Assem. - AG - S3547 (Incl. Items 8, 13, 14, 15)
13	38522065	Wheel - AG (2)
14	37258130	PTO Cover - AAP
	37258134	PTO Cover - ABU - S3523, 27
	37258136	PTO Cover - AG - S3547
15	41432040	Wheel Carrier Assem.
16	36424010	Bag Collar Support - AG
17	4010064S	Throw Away Bag Assem. - 3 Pk.
18	38422162	Switch Pedal - AAP - with Post
	38422164	Switch Pedal - AG - w/o Post (Use with 28218048 Switch)
19	36424012	Bag Collar Seal
20	36151027	Bag Lid Hinge - AG (2)
21	37944005	Filter Retainer - AG
22	38765009	Secondary Filter
23	Note: Bag Lid Assembly's include Items 19, 24, 25	
	42217132	Bag Lid Assem. - AAS - S3509
	42217138	Bag Lid Assem. - ABB - S3519
	42217136	Bag Lid Assem. - AG - S3511
	42217155	Bag Lid Assem. - ACA - S3523
	42217156	Bag Lid Assem. - ABB - S3527
	42212135	Bag Lid Assem. - S3547
	42217172	Bag Lid Assem. - ABB - S3510
24	38351009	Torsion Spring - FW
25	36153041	Bag Lid Latch - AAS - S3509
	36153040	Bag Lid Latch - AG - S3510, S3511, S3547
	36153044	Bag Lid Latch - ABB - S3519, S3527
	36153054	Bag Lid Latch - ACA - S3523
26	34633002	Retainer Seal - LH
27	34123040	Retainer Seal - Center

Ref. No.	Part No.	Description
28	28212026	Switch - with Leads
	28218048	Switch - with Terminals
29	34135014	Switch Mounting Plate
30	38314022	Spring - FW
	38314026	Spring - S3510, S3523, S3527, S3547
	56513332	Owner Manual
	56513339	Owner Manual - S3547
	56513348	Owner Manual - S3510
	59814004	Carton
	58175100	Carton - S3523, S3527
	58175115	Carton - S3547
	58211011	Bottom Support - Front
	58211012	Bottom Support - Rear
	58362004	Top Support
	58368007	Mid Pad
CLEANING TOOLS - S3509, S3510, S3511, S3519 (P-240)		
	38617017	Crevice Tool - AG
	43414057	Furniture Nozzle - AG
	43414064	Dusting Brush Assem. - AG
	3863801P	Extension Tube - AG
	43434241	Hose - ABX/AG Molded (P-251)
	43434242	Hose - AAP/AAZ Molded - w S/C (P-251)
	43434260	Hose - AG- S3510 - (P-251)
	43414172	R & F Nozzle - STD - S3510 (P-188)
	0M114169	R & F Nozzle - STD -S3509, S3511 (P-188)
	43414101	R & F Nozzle - Dlx. - S3519 (P-188)
CLEANING TOOLS - S3523, S3527, S3547 (P-240)		
	38617017	Crevice Tool - AG
	43414057	Furniture Nozzle - AG
	43414064	Dusting Brush Assem. - AG
	3863801P	Ext. Tube - Poly - AG
	43453027	Ext. Tube - S3547 - AX
	43434241	Hose - ABX/AG - S3523, S3547 (P-251)
	43434242	Hose - ABX/AG - S/C - S3527 (P-251)
	0M114169	R & F Nozzle - STD - S3523, S3527 (P-188)
	43414170	R & F Nozzle - STD - S3547 (P-188)

Note: Refer to Data Label on cleaner for reference to Amp Rating

Motor Assembly

Models S3509, S3511, S3513, S3519
S3525, S3535, S3545





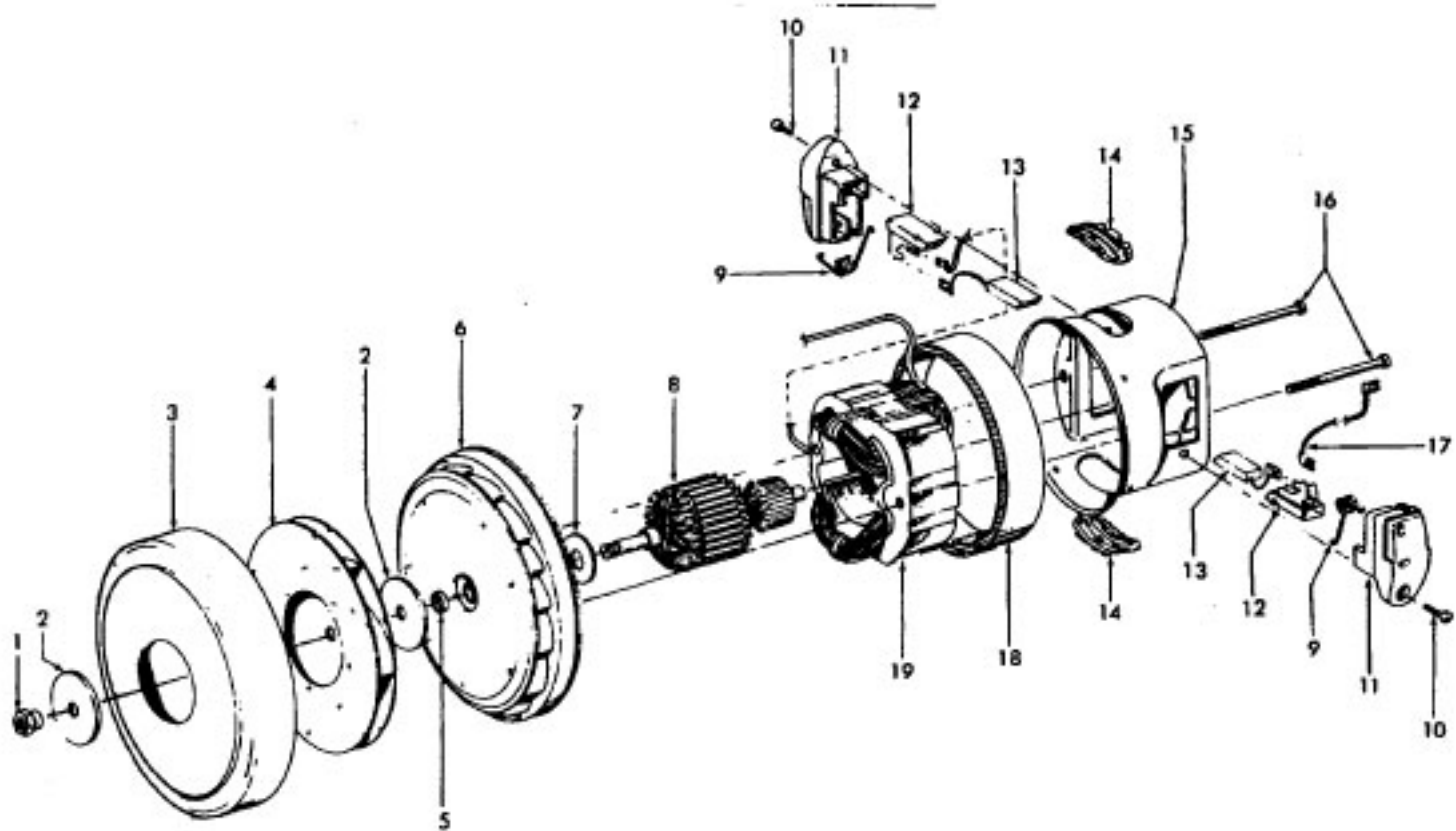



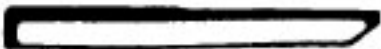

S3509 (7.8 Amp)
S3511 (7.8 Amp)
S3513 (7.8 Amp)
S3519 (7.8 Amp)
S3525 (9.7 Amp)
S3535 (9.7 Amp)
S3545 (10.4 Amp)

Note: Refer to Data Label on cleaner for reference to Amp rating.

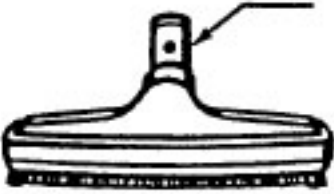
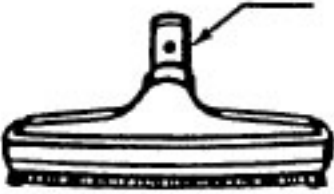

Ref. No.	Part No.	Description	Ref. No.	Part No.	Description
	43576126	Motor Assm. (Molded Diffuser)	9	38353004	Spring (2)
	43578071	Motor Assm. (Die Cast Diffuser)	10	21429406	Screw (2)
1	12028	Nut	11	168038AG	Brush Carrier (2)
2	21312774	Washer - FW (2)	12	168506	Brush Holder (2)
3	37196065	Fan Cover	13	167679	Motor Brush Assm. (.2)
4	43551008	Fan	14	169702BZ	Bushing (2)
5	31148009	Bearing Spacer (Use w/Die Cast Diffuser)	15	42193025	Motor Housing Assm.
	31148011	Bearing Spacer (Use w/Molded Diffuser)	16	36112006	Field Lamination Bolt (2) (Die Cast Diffuser)
6	43551012	Diffuser Assm. Comp. (Die Cast)		21447222	Field Lamination Bolt (2) (Phenolic Diffuser)
	43551030	Diffuser Assm. Comp. (Molded)	17	46176001	Lead Wire Assm.
7	31165003	Bearing Retainer Plate (Die Cast Diffuser)	18	36322031	Motor Gasket
8	44765220	Armature Assm.	19	45311048	Field Assm.

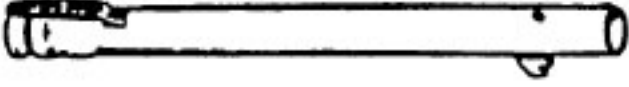
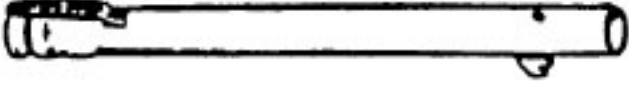
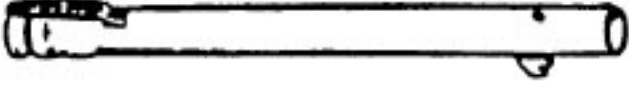
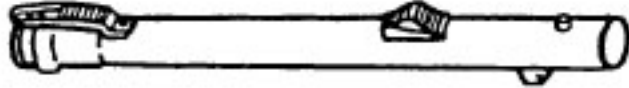
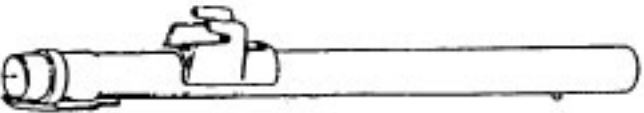
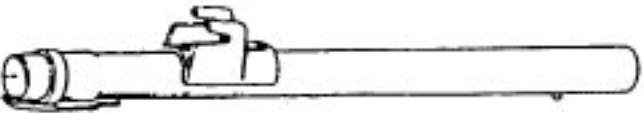
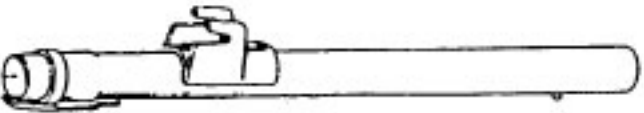
Cleaning Tools - Futura, Spectrum, Dimension, WindTunnel

	38617017	Crevice Tool - AG
	43414057	Furniture Nozzle - AG
	43414141	Furniture Nozzle - ABR
	43414064	Dusting Brush - AG
	38644020	Swivel Connector - AG
	38644040	Swivel Connector - AAP
	43414073	Floor Brush - AG
	48447001	Brush Back
	36172584	Cord/Wand Clip
	43453052	Ext. Tube - 20 - AX
	43453027	Ext. Tube
	43453058	Ext. Tube - BL 20 w/o Cord Clip
	43453023	Ext. Tube - AX 20
	43453095	Ext. Tube - AX 20 (Black Storage Clip) (Spectrum)
	43453098	Ext. Tube - AX 20 (Gray Storage Clip) (Futura)
	43453099	Ext. Tube - AX 20 (Black Storage Clip) (WindTunnel Canister)
	3863801P	Extension Tube - Poly - AG