

This Owner's Manual is provided and hosted by [Appliance Factory Parts](#).

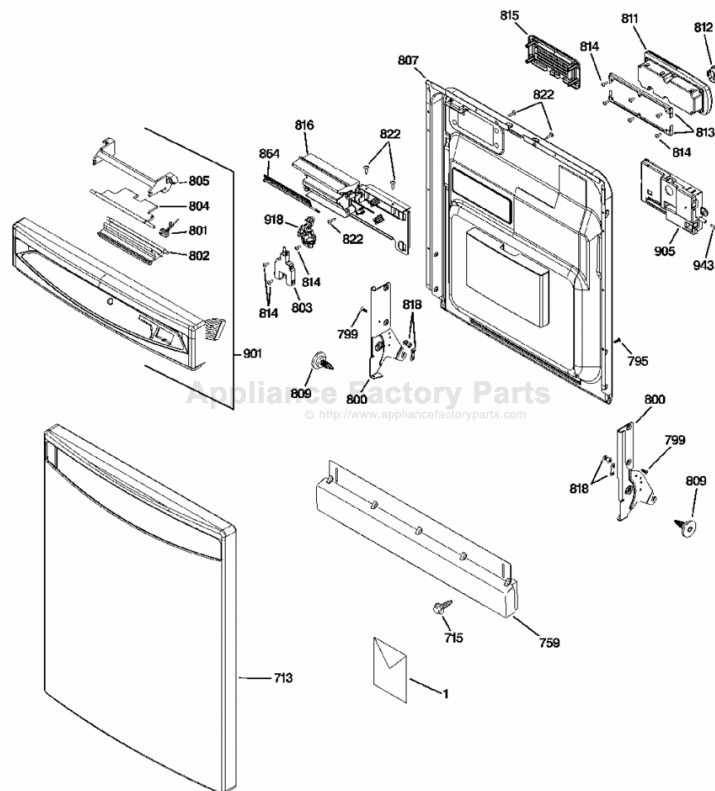

GE PDW8280J03SS Owner's Manual

[Shop genuine replacement parts for GE
PDW8280J03SS](#)



[Find Your GE Dishwasher Parts - Select From 6722 Models](#)

----- Manual continues below -----



GE Profile™ Dishwashers

Safety Instructions 2, 3

Operating Instructions

Care and Cleaning 15
Control Panel and Settings 4-7
Flashing Display Lights 7
Loading Place Settings 14
Loading the Racks 12-14
Using the Dishwasher 8-11

Troubleshooting Tips 16-18

Consumer Support

Consumer Support 24
Product Registration 19, 20
Warranty 23

Owner's Manual

PDW8000 Series
PDW9000 Series

Write the model and serial numbers here:

Model # _____

Serial # _____

You can find them on the tub wall just inside the door.

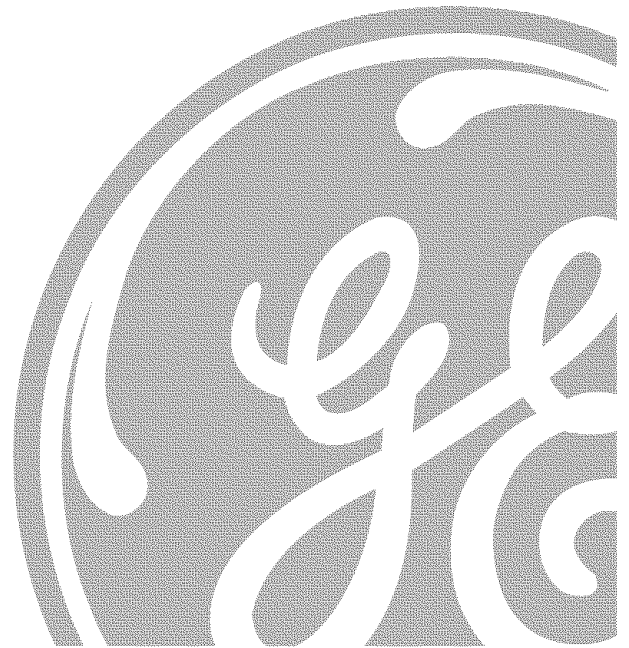

IMPORTANT SAFETY INFORMATION.

READ ALL INSTRUCTIONS BEFORE USING —

SAVE THESE INSTRUCTIONS

▲ WARNING!

For your safety, the information in this manual must be followed to minimize the risk of fire or explosion, electric shock, and to prevent property damage, personal injury, or death.



▲ WARNING! WATER HEATER SAFETY

Under certain conditions, hydrogen gas may be produced in a water heater that has not been used for two weeks or more. **HYDROGEN GAS IS EXPLOSIVE.**

If the hot water has not been used for two weeks or more, prevent the possibility of damage or injury by turning on all hot water faucets and allow them to run for several minutes. Do this before using any electrical appliance which is connected to the hot water system. This simple procedure will allow any built-up hydrogen gas to escape. Since the gas is flammable, do not smoke or use an open flame or appliance during this process.



PROPER INSTALLATION AND MAINTENANCE

This dishwasher must be properly installed and located in accordance with the Installation Instructions before it is used. If you did not receive an Installation Instructions sheet with your dishwasher, you can receive one by visiting our website at ge.com.

- Connect to a grounded metal, permanent wiring system; or run an equipment-grounding conductor with the circuit conductors and connect to the equipment-grounding terminal or lead of the appliance.
- Improper connection of the equipment-grounding conductor can result in a risk of electric shock. Check with a qualified electrician or service representative if you are in doubt whether the appliance is properly grounded.
- Dispose of discarded appliances and shipping or packing material properly.
- Do not attempt to repair or replace any part of your dishwasher unless it is specifically recommended in this manual. All other servicing should be referred to a qualified technician.
- To minimize the possibility of electric shock, disconnect this appliance from the power supply before attempting any maintenance.

NOTE: Turning the dishwasher off does not disconnect the appliance from the power supply. We recommend having a qualified technician service your appliance.

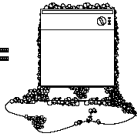
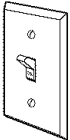

▲ CAUTION: To prevent minor injury or property damage

- Contents washed in Anti-bacterial mode, if available, may be hot to the touch. Use care before handling.
- Using a detergent that is not specifically designed for dishwashers will cause the dishwasher to fill with suds.
  = 
- If your dishwasher is connected to a wall switch, ensure that the switch is on prior to use.
 
- On dishwashers with electronic controls, if you choose to turn the wall switch off between wash cycles, allow 5-10 seconds after turning the switch on before touching START/RESET to allow the control to reboot.
- Non-Dishware Items: Do not wash items such as electronic air cleaner filters, furnace filters and paint brushes in your dishwasher. Damage to dishwasher and discoloration or staining of dishwasher may result.
- Close supervision is necessary if this appliance is used by or near children.
- Load light, plastic items so they will not become dislodged and drop to the bottom of the dishwasher—they might come into contact with the heating element and be damaged.

▲ **WARNING! RISK OF CHILD ENTRAPMENT**

PROPER DISPOSAL OF THE DISHWASHER

Junked or abandoned dishwashers are dangerous... even if they will sit for "just a few days." If you are getting rid of your old dishwasher, please follow the instructions to help prevent accidents.

Before You Throw Away Your Old Dishwasher

Take off the door of the washing compartment or remove the door latch (as shown).

NOTE: PDW9200–PDW9900 Series models also have a latch screw which must be removed (Step 1) as shown.

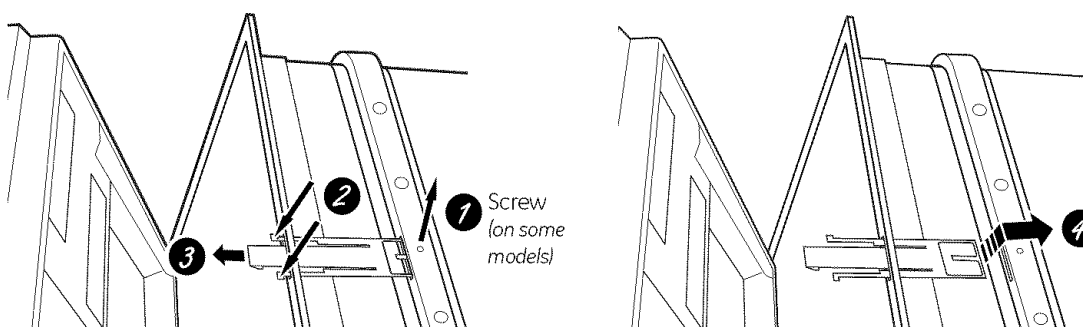

▲ **WARNING!**

When using your dishwasher, follow basic precautions, including the following:

- Use this appliance only for its intended purpose as described in this Owner's Manual.
- Use only powder, tabs, liquid detergents or rinse agents recommended for use in a dishwasher and keep them out of the reach of children. **Cascade®**, **Cascade® Complete** and **Electrasol®** Automatic Dishwashing Detergents, and **Jet-Dry®** and **Cascade Crystal Clear®** rinse agents have been approved for use in all GE dishwashers.
- **Do not mix any chlorine bleach-based automatic dishwashing detergent with any dishwashing detergent containing enzymes as this could cause the detergents to congeal and lead to blockage of the SmartDispense™ system.**
- Locate sharp items so that they are not likely to damage the door seal.
- Load sharp knives with the handles up to reduce the risk of cut-type injuries.
- Do not wash plastic items unless marked dishwasher safe or the equivalent. For plastic items not so marked, check the manufacturer's recommendations.
- Do not touch the heating element during or immediately after use.
- Do not operate your dishwasher unless all enclosure panels are properly in place.
- Do not tamper with controls.
- Do not abuse, sit on or stand on the door or dish rack of the dishwasher.
- Do not allow children to play around dishwasher when opening or closing door due to the possibility of small fingers being pinched in door.
- Do not discard a dishwasher without first removing the door of the washing compartment or the door latch.
- Do not store or use combustible materials, gasoline or other flammable vapors and liquids in the vicinity of this or any other appliance.
- Do not allow children to play with, on or inside this appliance or any discarded appliance.



READ AND FOLLOW THIS SAFETY INFORMATION CAREFULLY.

SAVE THESE INSTRUCTIONS

About the dishwasher control panel.

You can locate your model number on the tub wall just inside the door. Throughout this manual, features and appearance may vary from your model.

PDW8100 Series–PDW8900 Series

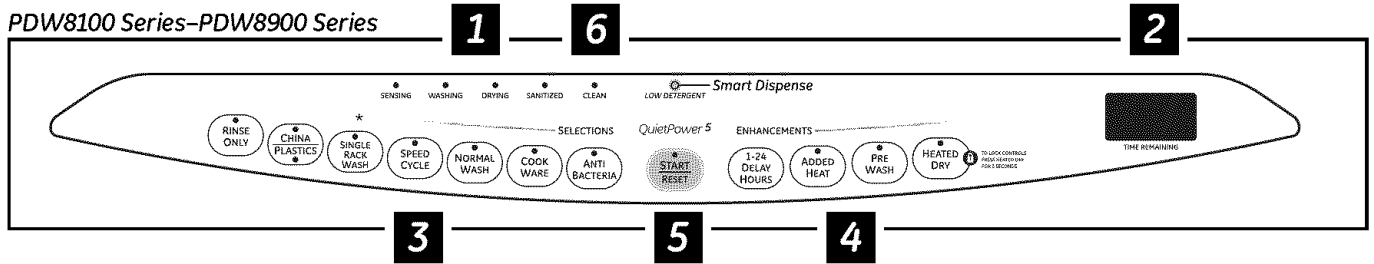

PDW9200 Series–PDW9900 Series

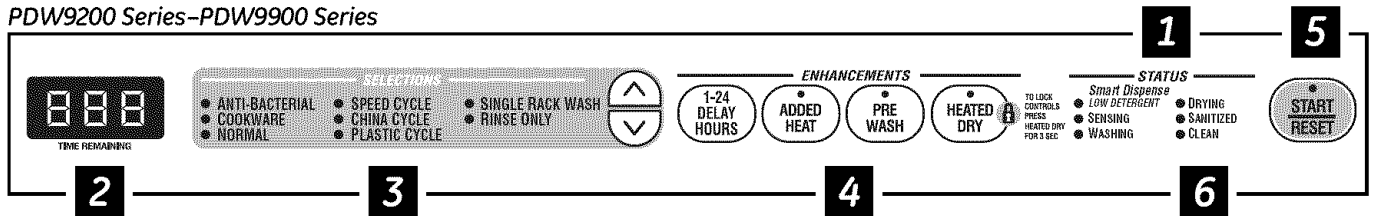

Control Settings

1 Status Indicator Lights (Indicators vary by models)

The Status display tells you what is happening while the dishwasher is in operation and may flash, indicating a malfunction. The lights will come **ON** indicating the sequence of the dishwasher operation.

LOW DETERGENT Displayed when the SmartDispense™ needs to be refilled with liquid or gel automatic dishwasher detergent.

NOTE: If you are not using SmartDispense™ and you want to turn the **LOW DETERGENT** LED light off, press the **ADDED HEAT** pad 5 times within 3 seconds. You will hear 3 beeps; then the light will go off. You can turn the light back on by pressing the **ADDED HEAT** pad 5 times within 3 seconds.

SENSING Displayed while the Clean Sensor™ is measuring the amount of soil and temperature of water. The dishwasher will adjust the selected cycle to achieve optimal performance.

ADD-A-DISH Displayed during prewash, indicating that dishes added now will still be cleaned.

WASHING Displayed during prewash, main wash and rinse periods.

RINSING Displayed during rinse periods.

DRYING Displayed during **HEATED DRY**.

SANITIZED Displayed when cycle has met sanitization conditions.

CLEAN Displayed when a wash cycle is complete.

2 Time Remaining Display (on some models)

During operation, the display shows the minutes remaining until the cycle is complete. The display may adjust the remaining time while the Sensing light is on. The time displayed at the start of each cycle may change from the factory setting as the unit customizes itself to home use. During a delay start, the display will show hours of time remaining until the cycle starts.

3 Selections

PDW8000 Series: Press the pad for the desired wash cycle.

PDW9000 Series: Use the Arrow Pads (▲▼) to scroll through the wash cycles.

NOTE: All cycle times and water usage information contained in the following section are approximate values. Actual results will depend on several factors, including but not limited to inlet temperature, household water pressure and amount of soil in the wash water.

The light above or next to the selected pad will be **ON** to indicate which **WASH CYCLE** has been selected.

3 Selections (continued)

ANTI-BACTERIA **Heavy** 8.8 gal., 105 min.
Medium 7.5 gal., 95 min.
Light 6.3 gal., 85 min.

This cycle raises the water temperature in the final rinse to sanitize your dishware. The cycle length will vary depending on the temperature of your inlet water.

NOTE: The Anti-Bacteria cycle is monitored for sanitization requirements. If the cycle is interrupted during or after the main wash portion or if the incoming water temperature is so low that adequate water heating cannot be achieved, the sanitizing conditions may not be met. In these cases, the sanitized light will not illuminate at the end of the cycle.

NOTE: NSF-certified residential dishwashers are not intended for licensed food establishments.

COOKWARE (POTS & PANS) **Heavy** 10.0 gal., 80 min.
Medium 8.8 gal., 70 min.
Light 7.5 gal., 60 min.

This cycle is meant for heavily soiled dishes or cookware with dried-on or baked-on soils. This cycle may not remove burned-on foods. Everyday dishes are safe to be used in this cycle.

NORMAL WASH **Heavy** 8.8 gal., 70 min.
Medium 7.5 gal., 60 min.
Light 5.0 gal., 50 min.

This cycle is for medium/heavily soiled dishes and glassware.

SPEED CYCLE 7.5 gal., 35 min.
 (on some models) This cycle is for everyday dishes and glassware.

CHINA CRYSTAL 7.5 gal., 35 min.
 This cycle is for lightly soiled china and crystal.

GLASSES 7.5 gal., 30 min.
 (on some models) This cycle is specifically designed for glasses.

PLASTICS CYCLE **Heavy** 8.8 gal., 120 min.
 (on some models) **Medium** 7.5 gal., 105 min.
Light 5.0 gal., 90 min.

The longer time for this cycle includes a built-in drying portion that is specifically designed to reduce the risk of melting plastic items and improve plastic drying. For removing red tomato-based stains, GE recommends the use of Cascade® Plastic Booster™.

SINGLE RACK WASH **Heavy** 8.2 gal., 70 min.
 (on some models) **Medium** 7.0 gal., 60 min.
Light 4.6 gal., 50 min.

This cycle washes lightly soiled dishes on the **upper rack only**.

RINSE ONLY 2.5 gal., 10 min.

For rinsing partial loads that will be washed later. Do not use detergent with this cycle.

NOTE: On the PDW8000 Series models, the **CHINA CRYSTAL/PLASTICS** selector is a toggle pad; push pad to switch between **CHINA CRYSTAL** and **PLASTICS**.

NOTE: This dishwasher is equipped with CleanSensor™ with automatic temperature control; therefore, cycle length and time may vary depending on soil and water temperature conditions.

NOTE: Only the Anti-Bacteria cycle has been designed to meet the requirements of Section 6, NSF 184 for soil removal and sanitization efficacy.

About the dishwasher control panel.

4 Enhancements

The light above the selected pad will be **ON** to indicate which **ENHANCEMENT** has been selected.

DELAY HOURS You can delay the start of a wash cycle for up to 24 hours (depending on model). Press the **DELAY START** pad to choose the number of hours you want to delay the start of the cycle; then press **START/RESET**.

PDW8000 Series: The machine will count down and start automatically at the correct time.

PDW9000 Series: After closing the door, the machine will count down and automatically start at the correct time.

NOTE: To cancel the **DELAY START** selection before the cycle begins, repeatedly press the **DELAY START** pad until the display is blank.

ADDED HEAT (EXTRA HOT WASH) When selected, the cycle will run longer with heating element on to improve both wash and dry performance.

NOTE: Cannot be selected with **RINSE ONLY** cycle.

PRE WASH (on some models) For use with heavily soiled and/or dried-on, baked-on soils. This option **MUST** be selected **PRIOR** to starting the cycle. This option adds 15 minutes to the cycle time.

NOTE: Cannot be selected with **RINSE ONLY** cycle.

HEATED DRY Light Off Shuts off the drying heat option. Dishes will air dry naturally (PDW8900 Series) or fan dry (PDW9200–PDW9900 Series) to save energy.

HEATED DRY Light On Turns the heater on for fast drying. This will extend the total cycle time by 15 minutes for the **ANTI-BACTERIAL** cycle, 38 minutes for the **NORMAL, SINGLE RACK WASH** and **COOKWARE** cycles, 8 minutes for the **SPEED** cycle, 15 minutes for the **PLASTICS** cycle and 30 minutes for all other cycles.

NOTE: Cannot be selected with **RINSE ONLY** cycle.

LOCK You can lock the controls to prevent any selections from being made. Or you can lock the controls after you have started a cycle.



Children cannot accidentally start dishwasher by touching pads with this option selected.

To unlock the dishwasher controls, press and hold the **HEATED DRY** pad for 3 seconds. The light above the lock pad will turn off. To lock the dishwasher, press and hold the **HEATED DRY** pad for 3 seconds. The light above the **LOCK** pad will turn on.

RESET To change a cycle after washing starts..

PDW8000 Series: Touch the **START/RESET** pad to cancel the cycle. The **START/RESET** light will flash while the water is pumped out if needed. This takes approximately 2 minutes.

PDW9000 Series: Open the door slowly to prevent splash-out. Touch the **START/RESET** pad to cancel the cycle. If the **START/RESET** light is flashing, close the door until the water pumps out (this takes approximately 2 minutes) and the light stops flashing.

When the light stops flashing, the dishwasher can be reprogrammed and restarted.

5 Start

PDW8000 Series

Close and latch the dishwasher door and select the cycle and desired enhancements. Touch the **START/RESET** pad to begin the cycle. Water fill begins immediately, and approximately 60 seconds later the wash action begins.

When the dishwasher door is fully closed and latched, the control panel lights will display the last settings you selected. If you don't want to change any of the settings, simply touch the **START/RESET** pad to begin the cycle.

If the door is closed, the indicator lights will turn off if the **START/RESET** pad is not selected within 5 minutes. To activate the display, open and close the door or press any pad.

5 *Start (continued)***PDW9000 Series**

After selecting the cycle and desired enhancements, touch the **START/RESET** pad to ready the dishwasher to begin the cycle. Close the door to start the cycle or begin the **DELAY START** countdown. When the cycle starts, the water fill begins and approximately 60 seconds later the wash action begins. The dishwasher will always display your last selection and enhancements. If you don't want to change the settings, simply touch the **START/RESET** pad to ready the dishwasher and close the door to begin the cycle.

Also, if a power failure occurs **NORMAL** and **HEATED DRY** will automatically be programmed. Make any new selections and touch the **START/RESET** pad to begin the new cycle.

When the door is opened, the indicator lights will turn off if the **START/RESET** pad is not selected within 5 minutes. To activate the display, open and close the door or touch any pad.

6 *Clean***PDW8000 Series**

The **CLEAN** light is illuminated when the selected cycle and enhancements are complete. The light will stay **ON** until a pad is pressed or the door is opened and then closed.

PDW9200 Series–PDW9900 Series

The **CLEAN** light is illuminated and a double beep will sound when the selected cycle and enhancements are complete. You may remove the dishes at any time. The high-efficiency fan will run quietly for 30 minutes to 4 hours (depending on selected cycle) after the **CLEAN** light is illuminated to continue drying the dishes. The fan can be turned off by opening the door and pressing any keypad.

ALL MODELS: To turn off the audible end-of-cycle signal (or re-activate it if it was previously turned off), press the **HEATED DRY** pad 5 times within 3 seconds. A triple beep will sound to indicate the end-of-cycle beep option has been toggled.

Flashing display lights.

Status Indicator Lights	What It Means
START/RESET	Cycle has been interrupted by pressing the START/RESET pad, or there has been a power failure. Light will stop flashing after the dishwasher automatically drains out the water. The dishwasher will restart if the interruption was the result of a power failure.

Recommended dishwasher products.

GE recommends the following products for use in its dishwashers:

- For your manual detergent dispenser, **Cascade®** and **Electrasol®** powder, liquid or gel automatic dishwasher detergents are approved.
- For your SmartDispense™ Detergent Dispenser, use only the recommended detergents listed on page 10 of this manual.
- **Jet Dry®** or **Cascade Crystal Clear®** rinse agents to remove spots and prevent new film buildup on your dishes, glasses, flatware, cookware and plastic. Using rinse agent also improves dry performance.
- **Cascade® Plastic Booster™** to remove red staining inside your dishwasher that can come from some tomato-based foods.
- **Cerama Bryte®** Stainless Steel Appliance Cleaner to clean the exterior stainless steel panel of GE and Profile™ dishwashers (for stainless steel exterior models only).

Using the dishwasher.



Check the Water Temperature

The entering water should be at least 120°F and not more than 150°F for effective cleaning and to prevent dish damage. Check the water temperature with a candy or meat thermometer. Turn on the hot water faucet nearest the dishwasher, place the thermometer in a glass and let the water run continuously into the glass until the temperature stops rising.



Use Jet-Dry® or Cascade Crystal Clear® Rinse Agent

Jet-Dry® or **Cascade Crystal Clear®** rinse agent improves drying, removes spots and prevents new film buildup on your dishes, glasses, flatware, cookware and plastic.

Filling the Dispenser

The rinse agent dispenser holds 3.5 oz. of rinse agent. Under normal conditions, this will last approximately one month. Try to keep it full, but do not overfill.

- 1 Make sure the dishwasher door is fully open.
- 2 Turn the dispenser cap to the left and lift it out.
- 3 Add rinse agent until the indicator window looks full.
- 4 Clean up any spilled rinse agent with a damp cloth.
- 5 Replace the dispenser cap.



Rinse Aid Setting

The amount of rinse agent released into the final wash can be adjusted. The factory setting is at the midpoint. If there are rings of calcium (hard water) spots on dishes, try a higher setting. If there is foaming, use a lower setting.

To adjust the setting:

Remove the dispenser cap; then turn the adjuster counterclockwise to increase the amount of rinse agent or clockwise to reduce the amount of rinse agent dispensed.

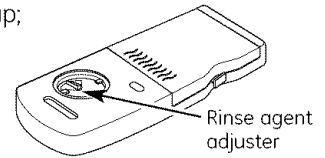

Dish Preparation Prior to Loading

- No prerinsing of normal food soil is required.
- Remove large quantities of any remaining food.
- Scrape off hard soils, bones, toothpicks, skins and seeds.
- Remove leafy vegetables, meat trimmings and excessive amounts of grease or oil.



Manual Detergent Dispenser

Your dishwasher comes equipped with an automatic liquid dishwasher detergent dispenser (SmartDispense™) and a manual dispenser. You can use either of these dispensers but don't use both at the same time.

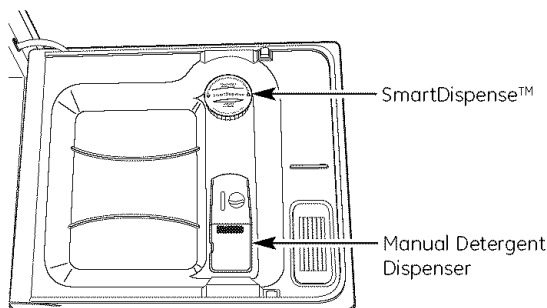

The cover of the manual dispenser will open during the wash cycle. If you are using SmartDispense™, leave the cover of the manual dispenser open before starting the cycle.

For the manual dispenser, *Cascade*® and *Electrasol*® Automatic Dishwashing Detergents have been approved. You may use powder, liquid, gel or tablets in this dispenser. It is important to keep powdered detergents and tablets fresh and dry so they don't lose effectiveness. Therefore, do not put detergent into the manual dispenser until you are ready to wash dishes.

Filling Manual Detergent Dispenser

The amount of detergent to use depends on whether your water is *hard* or *soft*. With hard water, you need extra detergent. With soft water, you need less detergent.

Protect your dishes and dishwasher by contacting your water department and asking how hard your water is. Twelve or more grains is extremely hard water. A water softener is recommended. Without it, lime can build up in the water valve, which could stick while open and cause flooding. Too much detergent with soft water can cause a permanent cloudiness of glassware, called *etching*.

Use the information in the table below as a guide to determine the amount of automatic dishwasher detergent to place in the dispenser. You may use powder, liquid, gel or tablets in this dispenser.

When using automatic dishwashing detergent tablets, simply place one tablet in the main wash section and close the cover.

Number of Grains	Detergent Cups to Fill
Less than 4	Fill cup to soft line (1/3 full)
4 to 8	Fill cup to medium soft line (2/3 full)
8 to 12	Fill cup to medium hard line (completely full)
Greater than 12	Fill both main wash cup and pre wash cup

For heavily soiled loads, use a bit more detergent. For water temperatures above 140°F, use a bit less detergent.

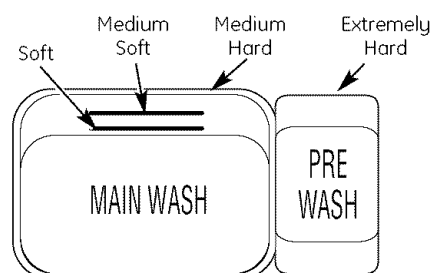

For heavily soiled loads, use the *Pots and Pans* or *Heavy Wash* cycle.

DO NOT USE HAND DISH DETERGENT

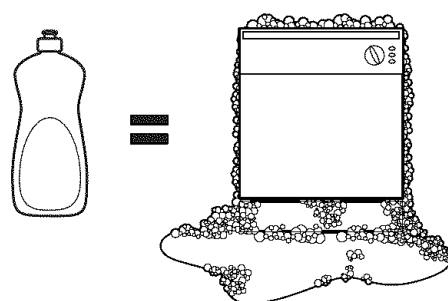

NOTE: Using a detergent that is not specifically designed for dishwashers will cause the dishwasher to fill with suds. During operation, these suds will spill out of the dishwasher vents, covering the kitchen floor and making the floor wet.

Because so many detergent containers look alike, store the dishwasher detergent in a separate space from all other cleaners. Show anyone who may use the dishwasher the correct detergent and where it is stored.

While there will be no lasting damage to the dishwasher, your dishes will not get clean using a dishwashing detergent that is not formulated to work with dishwashers.

Using the dishwasher.

SmartDispense™ Detergent Dispenser (some models)

This dishwasher may have SmartDispense™, a feature which automatically dispenses liquid automatic dishwasher detergent into each cycle based on soil level and water hardness.

To utilize the SmartDispense™ Detergent Dispenser, it must first be filled. Although any liquid or gel automatic dishwashing detergent can be used in the SmartDispense™ system, all liquid or gel automatic dishwashing detergents are not the same. Most automatic dishwashing detergents are chlorine bleach-based (such as Cascade® or Electrasol®) while others contain enzymes (such as Cascade Complete®).

Do not mix any chlorine bleach-based automatic dishwashing detergent with any dishwashing detergent containing enzymes as this could cause the detergents to congeal and lead to blockage of the SmartDispense™ system. Check the detergent label to determine if the detergent is chlorine bleach-based or one that contains enzymes. It is recommended that the same type of detergent be used when refilling your SmartDispense™ system.

CAUTION! Absolutely do not add powder detergent, tablets or any liquid soap or detergent normally used for washing hands or dishes in a sink. Only use liquid or gel detergent specifically designed for use in an automatic dishwasher.

To open the dispenser for filling, push down and turn the blue cap counterclockwise until the cap is loose. Lift cap off.

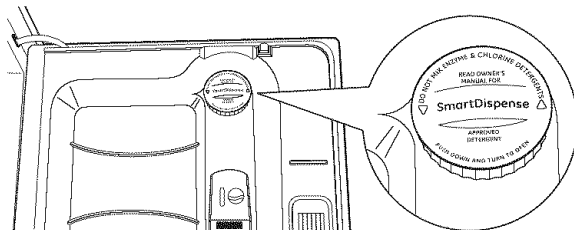

Set the door at a comfortable angle to fill the dispenser.

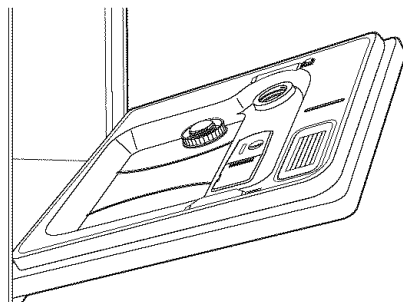

Aim the detergent bottle at the opening in the door and begin to fill.

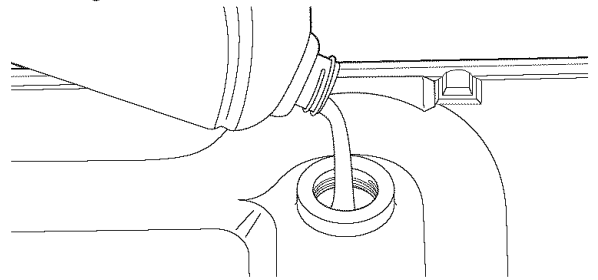

The dispenser will hold 45 oz of liquid dishwasher detergent (standard size bottle).

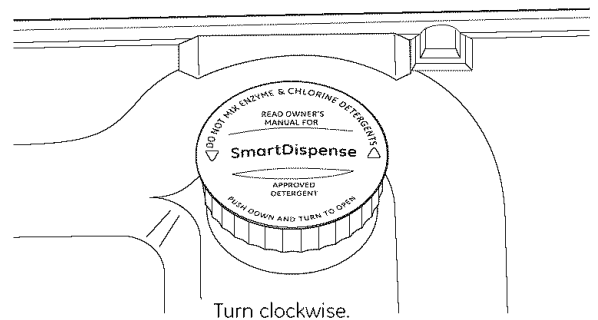

When full, replace the cap and turn clockwise until tight. If residue is left on the door, it will be washed off in the next cycle.

An indicator light will turn on to notify you when the dispenser needs to be filled again. After filling, the light will not turn off until the door is closed. A full dispenser will last approximately 1 month for the average user.

		STATUS	
Light will turn on when time to refill	○	SmartDispense LOW DETERGENT	● DRYING
	●	SENSING	● SANITIZED
	●	WASHING	● CLEAN

(appearance may vary)

NOTE: If you are not using SmartDispense™ and you want to turn the **LOW DETERGENT** LED light off, press the **ADDED HEAT** pad 5 times within 3 seconds. You will hear 3 beeps; then the light will go off. You can turn the light back on by pressing the **ADDED HEAT** pad 5 times within 3 seconds.

SmartDispense™ Detergent Dispenser Water Hardness Calibration

Prior to the first use, the dishwasher needs to be calibrated for water hardness. Please follow directions below to calibrate the dishwasher to the hardness of your tap water.

Determine the Hardness of Your Tap Water

In the bag that contained these instructions, you should find a water hardness test strip package. Read the instructions on the package, remove the test strip and follow the instructions to determine the hardness level of your tap water. You will use this information to calibrate your dishwasher to dispense the optimal amount of detergent.

Water hardness test strip indication



Calibration of 12-Button Front-Control Models With 3-Digit Display

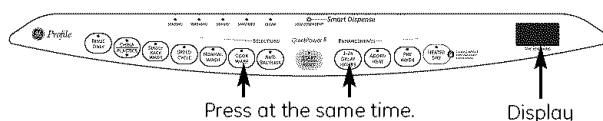

- 1 Close and latch the door (lights on, dishwasher not running).
- 2 Press the **COOKWARE** and **DELAY HOURS** pads at the same time for 3 seconds. The display will show a number from **1** to **5**. This is the water hardness value currently set.
- 3 Press the **COOKWARE** pad to raise the value or the **NORMAL** pad to lower the value. Set the water hardness value to the number determined with the test strip and table above.
- 4 Once the water hardness is set, press the **START/RESET** pad to save the setting and return the dishwasher to normal operation.

Calibration of 7-Button Front-Control Models With 3-Digit Display



- 1 Open the door and touch a pad (other than **START**) to turn lights on.
- 2 Press the "Up" Arrow Pad and **DELAY HOURS** pad at the same time for 3 seconds. The display will show a number from **1** to **5**. This is the water hardness value currently set.

- 3 Press the "Up" Arrow Pad to raise the value or the "Down" Arrow Pad to lower the value. Set the water hardness value to the number determined with the test strip and table at the left.
- 4 Once the water hardness is set, press the **START/RESET** pad to save the setting and return the dishwasher to normal operation.

Calibration of Models Without a 3-Digit Display

Front controls

- 1 Close and latch the door (lights on, dishwasher not running).
- 2 Press the **COOKWARE** and **DELAY HOURS** pads together for 3 seconds. All lights will light up and you will hear 1 to 5 beeps. The number of beeps indicates the current hardness value.
- 3 To change the setting, press the **DELAY HOURS** pad the number of times that corresponds to the water hardness value determined at the left. The control will beep each time you press the pad.
- 4 Once finished pressing the pad, you will hear a confirmation with beeps for the number of times you pressed the pad.
- 5 If the number of beeps is not what you desire, start pressing the **DELAY HOURS** pad again to reenter a new water hardness level.
- 6 Once the water hardness is set, press the **START/RESET** pad to save the setting and return the dishwasher to normal operation.

Top controls

- 1 Open the door and touch a pad to turn lights on.
- 2 Press the "Up" Arrow Pad and **DELAY HOURS** pad at the same time for 3 seconds. All lights will light up and you will hear 1 to 5 beeps. The number of beeps indicates the current hardness value.
- 3 To change the setting, press the **DELAY HOURS** pad the number of times that corresponds to the water hardness value determined at the left. The control will beep each time you press the pad.
- 4 Once finished pressing the pad, you will hear a confirmation with beeps for the number of times you pressed the pad.
- 5 If the number of beeps is not what you desire, start pressing the **DELAY HOURS** pad again to reenter a new water hardness level.
- 6 Once the water hardness is set, press the **START/RESET** pad to save the setting and return the dishwasher to normal operation.

NOTE: You should recalibrate the dishwasher control if water conditions change; for example, if a water softener system is added or removed from your home.

Loading the dishwasher racks.

For best dishwashing results, follow these loading guidelines. Features and appearance of racks and silverware baskets may vary from your model.

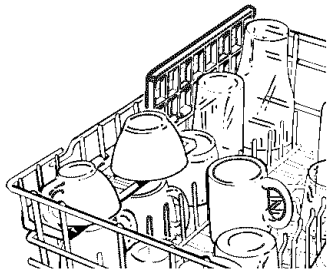

Upper Rack

Although the upper rack is primarily for glasses, cups and saucers, pots and pans can be placed in this rack for effective cleaning. Cups and glasses fit best along the sides. This is also a secure place for dishwasher plastics.

The utility shelf (some models) may be placed in the up or down position to add flexibility. A wine glass holder (some models) secures wine glasses for best washability.

Some models have contoured metal cup shelves that can secure up to 12 wine glasses (as shown).

Because wine glasses come in various sizes, after loading, slowly push in the rack to make sure they will clear the top of the dishwasher.

Some models have an Angled Rack System, which allows you to angle your dishes, such as coffee mugs, for better cleaning and quicker drying. To position the tines, pull the lever forward then drop the tines into position, then release the lever.

The upper rack is good for all kinds of odd-shaped utensils. Saucepans, mixing bowls and other items should be placed face down. Fold-down tines (on some models) provide flexibility for extra-large and hard-to-fit items.

Secure larger dishwasher-safe plastics over 2 times when possible.

Make sure small plastic items are secure so they can't fall onto the heater.

Be sure that items do not protrude through the bottom of the rack and block rotation of the middle spray arm. This could result in poor wash performance for items in the upper rack.

Check to make sure that no items will block rotation of the wash arm.

NOTE: The Single Rack Wash selection, on models with this feature, washes the upper rack only. If you use this feature, do not load items in the lower rack.

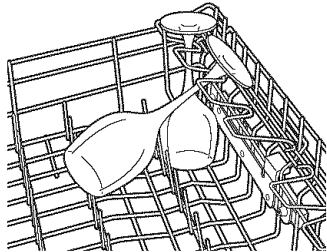

Adjustable Upper Rack

The standard position of your adjustable rack is "up" which allows for maximum clearance for your taller items in the lower rack. If you have taller wine glasses, tumblers or other items to place in the upper rack, you may want to adjust the rack to the lower position.

To lower the rack, support the weight of the rack with your hands as shown and press both finger pads about 1/4" toward the inside of the rack as indicated and guide the rack down to its lower position.

To raise the rack to the "up" position, pull up on the center of the rack side frame until the rack locks into place.



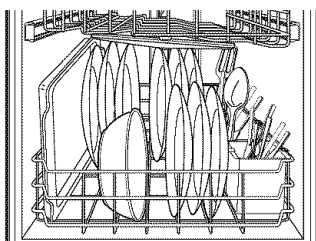

Lower Rack

The lower rack is best used for plates, saucers and cookware. Large items such as broiler pans and baking racks should go along the left-hand side. Load platters, pots and bowls along the sides, in corners or in the back. The soiled side of items should face the center of the rack. If necessary, oversized glasses and mugs can be placed in the lower rack to maximize loading flexibility.

Also, be careful not to let a portion of an item such as a pot or dish handle extend through the bottom rack. This could block the wash arm and cause poor washing results.

Fold-down tines (on some models) provide flexibility for extra-large and hard-to-fit items. The tines may be left in the up position or folded down to customize the lower rack.

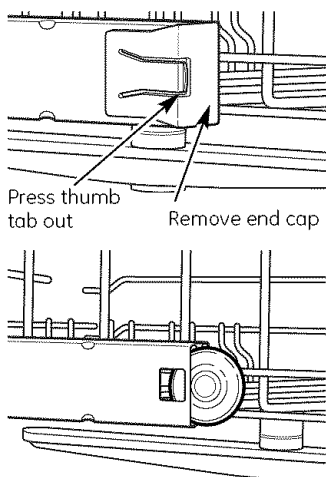

Removing the Upper Rack

You can remove the upper rack to allow space for large items in the lower rack.

NOTE: Do not use the **SINGLE RACK WASH** cycle (some models) with this feature. Single Rack Wash cycle is for upper rack wash only. The recommended cycle for lower rack only use is the **COOKWARE** cycle.

To remove the upper rack:

- 1 Press thumb tab out and remove the front end caps on each side of the rail.
- 2 Pull the rack straight out and off the rails.
- 3 Replace the end caps.
- 4 Push the rails all the way back into the dishwasher.

- 5 Slide the shower nozzle attachment (located in the bag that contained these instructions) over the spout.

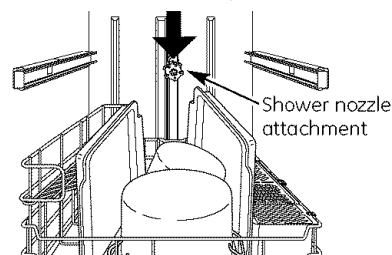

- 6 Then fill the lower rack and begin your cycle.

NOTE: Don't forget to remove the shower nozzle attachment before you replace the upper rack.

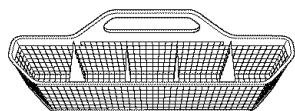

One-piece basket (on some models)

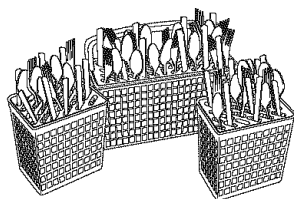

Three-piece basket (on some models)

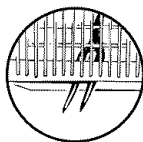

Don't let any item extend through bottom.

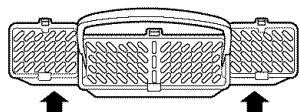

To remove end baskets, grasp the basket at opposite corners and slide apart.

Silverware Basket

To load flatware, simply push the adjustable handle to either side (on some models). Put flatware in the removable basket with fork and knife handles up to protect your hands. Place spoons in the basket with handles down. Mix knives, forks and spoons so they don't nest together. Distribute evenly. Small plastic items, such as measuring spoons and lids from small containers should go in the bottom of the silverware basket with the silverware on top.

The one-piece silverware basket (on some models) can be placed in the front, right side or back of the lower rack.

A variety of options is available regarding the three-piece silverware basket (on some models) in your dishwasher. The complete basket is designed to fit on the right side of the lower rack. Additionally, each end of the basket is removable to add loading flexibility to accommodate flatware and lower rack capacity needs.

The lids of both end and middle baskets (on some models) can be closed to contain small items. Long items can be placed on the utility shelf in the upper rack.

Loading the dishwasher racks.

Extra Rack Features (on some models)

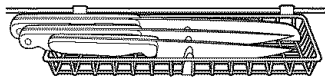

Cutlery Tray

The cutlery tray holds up to 4 large knives such as a carver, chef's knives, bread knife, etc., that are too tall to fit in the silverware basket.

Hook the tray onto the rear of the upper rack. Lay the knives between the guides (as shown).



Bowl Tines

The special large-bowl tines in the lower rack add flexibility to your loading pattern. They are useful for serving bowls or other large bowls.

To use the bowl tines, fold down the 2 rows of flex tines in front of the bowl tines and load bowls just as you would in the upper rack.

These tines fold down Large-bowl tines

Loading place settings...

Follow these guidelines for loading 10 place settings. Features and appearance of racks and silverware baskets may vary from your model. **NOTE:** Silverware should be individually loaded into the slots on the silverware basket lid.

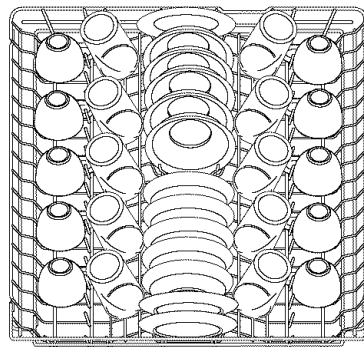

Upper Rack—10 place settings

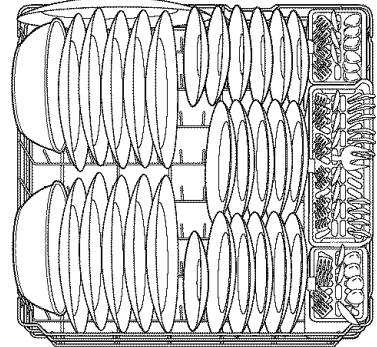

Lower Rack—10 place settings

Follow these guidelines for loading 12 place settings. Features and appearance of racks and silverware baskets may vary from your model. **NOTE:** Silverware should be individually loaded into the slots on the silverware basket lid.

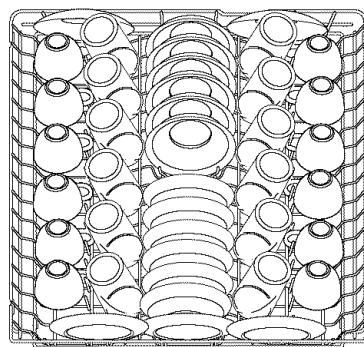

Upper Rack—12 place settings

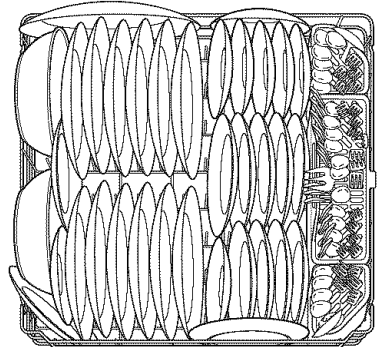

Lower Rack—12 place settings

Cleaning the Exterior Door Panel

Before cleaning the front panel, make sure you know what type of panel you have. Refer to the last two letters of your model number. You can locate your model number on the left-hand tub wall just inside the door. If your model number ends with BB, CC, WW, SA or BG, then you have a Painted Door panel. If your model number ends with SS, then you have a Stainless Steel Door panel. If your model number ends with CS, then you have a CleanSteel panel.

Follow the instructions below for cleaning the door panel for your specific model.

Painted Door Panel (model numbers ending in BB-black, CC-bisque, WW-White, SA-silver metallic or BG-graphite black)

Use a clean, soft, lightly dampened cloth, then dry thoroughly. You may also use a good appliance wax or polish.

Stainless Steel Door Panel (model numbers ending in SS)

The stainless steel panels can be cleaned with *Stainless Steel Magic* or a similar product using a clean, soft cloth. Do not use appliance wax, polish, bleach or products containing chlorine on Stainless Steel doors.

You can order *Stainless Steel Magic* #WX10X15 through GE Parts by calling 800.626.2002.

CleanSteel Door Panel (model numbers ending in CS)

Use a clean, soft, lightly dampened cloth, then dry thoroughly. Do not use appliance wax, polish or any chemical agent on CleanSteel doors.

Do not wipe the dishwasher with a soiled dish cloth or wet towel. These may leave a residue. Do not use scouring pads or powdered cleaners because these products can scratch the finish.

Stainless Steel Interior—Tub and Inner Door

The stainless steel used to make the dishwasher tub and inner door provides the highest reliability available in a GE dishwasher. If the dishwasher tub or inner door should be scratched or dented during normal use, they will not rust or corrode. These surface blemishes will not affect their function or durability.

Cleaning the Control Panel

To clean the control panel, use a lightly dampened cloth. Then dry thoroughly.

Protect Against Freezing

If your dishwasher is left in an unheated place during the winter, ask a service technician to:

- 1 Cut off electrical power to the dishwasher. Remove fuses or trip circuit breaker.
- 2 Turn off the water supply and disconnect the water inlet line from the water valve.

- 3 Drain water from the water inlet line and water valve. (Use a pan to catch the water.)
- 4 Reconnect the water inlet line to the water valve.



Check the air gap any time your dishwasher isn't draining well.

Does Your Dishwasher Have an Air Gap?

An air gap protects your dishwasher against water backing up into it if a drain clogs. The air gap is not a part of the dishwasher. It is not covered by your warranty. Not all plumbing codes require air gaps, so you may not have one.

The air gap is easy to clean.

- 1 Turn off the dishwasher and lift off the cover.
- 2 Remove the plastic cap and clean with a toothpick.

Before you call for service...



Troubleshooting Tips

Save time and money! Review the charts on the following pages, or visit ge.com. You may not need to call for service.

Error Messages	Possible Causes	What To Do
START/RESET status indicator light flashing	You have pressed the START/RESET pad while the dishwasher is running. This will cancel the cycle. The light will stop flashing after the dishwasher drains (about 90 seconds).	<ul style="list-style-type: none"> Press the START/RESET pad only one time to start the dishwasher. When the dishwasher is running, only press the START/RESET pad if you wish to cancel (reset) the cycle.
	Power to the dishwasher was turned off while a cycle was running and power has just been restored to the dishwasher. The blinking lights indicate that the dishwasher is draining water inside.	<ul style="list-style-type: none"> The light will stop flashing after the dishwasher drains out the water. A new cycle will start automatically when the drain ends.
Dishwasher BEEPS once every 30 seconds	This is a reminder that your dishwasher door has been left open during operation. It will continue beeping until you close the door.	<ul style="list-style-type: none"> Close and latch the door after opening it mid-cycle. Beeping will stop and dishwasher will complete cycle.
Beeping at the end of the cycle	This is normal. The dishwasher will beep twice at the end of the cycle.	<ul style="list-style-type: none"> To turn off the double beep indicator (or re-activate it if it was previously turned off), press the HEATED DRY pad 5 times within 3 seconds. A triple beep will sound to indicate the end-of-cycle beep option has been turned on or off.
Low Detergent Light ON	SmartDispense™ has less than 10 cycles worth of detergent left in the dishwasher.	<ul style="list-style-type: none"> Fill the SmartDispense™ reservoir with liquid dishwasher detergent. After filling the reservoir, the LOW DETERGENT light will turn OFF once the door is closed.

Problem	Possible Causes	What To Do
Dishes and flatware not clean	Low inlet water temperature	<ul style="list-style-type: none"> Make sure inlet water temperature is correct (see page 8). Turn on the hot water faucet nearest the dishwasher; let run until the water temperature stops rising. Then start the dishwasher and turn off the faucet. This ensures the entering water is hot. Try not to use the dishwasher when hot water is being used elsewhere in the house; for example, when doing laundry or when a family member is using the shower.
	Water pressure is temporarily low	<ul style="list-style-type: none"> Turn on a faucet. Is water coming out more slowly than usual? If so, wait until pressure is normal before using your dishwasher. Try not to use the dishwasher when hot water is being used elsewhere in the house; for example, when doing laundry or when a family member is using the shower.
	Air gap or disposer is clogged	<ul style="list-style-type: none"> Clean the air gap or flush the disposer.
	Improper rack loading	<ul style="list-style-type: none"> Make sure large dishware does not block the detergent dispenser or the wash arms. See the <i>Loading the dishwasher racks</i> section.
	No air gap or high drain loop	<ul style="list-style-type: none"> Verify that you have an air gap or a high drain loop. Refer to the Installation Instructions.

Problem	Possible Causes	What To Do
Spots and filming on glasses and flatware	Extremely hard water Low inlet water temperature Overloading the dishwasher Improper loading Old or damp powder detergent Rinse agent dispenser empty Too little detergent	<ul style="list-style-type: none"> Use Jet-Dry® or Cascade Crystal Clear® rinse agents to remove spots and prevent new film buildup. Make sure water temperature is at least 120°F. Load dishwasher as shown in the <i>Loading Place Settings</i> section. Make sure detergent is fresh. If water is extremely hard, a softener may be required.
Cloudiness on glassware	Combination of soft water and too much detergent	<ul style="list-style-type: none"> This is called <i>etching</i> and is permanent. To prevent this from happening, use less detergent if you have soft water. Wash glassware in the shortest cycle that will get them clean. Recalibrate the SmartDispense™ system if you are using it. See pages 9 and 11.
	Water temperature entering the dishwasher exceeds 150°F	<ul style="list-style-type: none"> This could be etching. Lower the water heater temperature.
Suds in the tub	Correct detergent wasn't used	<ul style="list-style-type: none"> Use only automatic dishwasher detergents to avoid sudsing. Cascade® and Electrasol® Automatic Dishwashing Detergents have been approved for use in all GE dishwashers. To remove suds from the tub, open the dishwasher and let suds dissipate. Close and latch the dishwasher door. Pump out water by touching the START/RESET pad once; then 30 seconds later, touch the START/RESET pad again. Repeat if necessary.
	 Rinse agent was spilled	<ul style="list-style-type: none"> Always wipe up rinse agent spills immediately.
Detergent left in dispenser cups or on door	Dishes are blocking the detergent cup or SmartDispense™ outlet	<ul style="list-style-type: none"> Reposition the dishes, so the water from the lower spray arm can flush the detergent cup or outlet from the SmartDispense™ system. See pages 13 and 14.
Black or gray marks on dishes	Aluminum utensils have rubbed against dishes	<ul style="list-style-type: none"> Remove marks with a mild, abrasive cleaner.
Dishes don't dry	Low inlet water temperature	<ul style="list-style-type: none"> Make sure inlet water temperature is at least 120°F. Select HEATED DRY. Use PRE WASH or ADDED HEAT options. Select a higher cycle, such as ANTI-BACTERIA or COOKWARE.
	Rinse agent dispenser is empty	<ul style="list-style-type: none"> Check the rinse agent dispenser and fill as required.
Control panel responded to inputs but dishwasher never filled with water	Door latch may not be properly seated	<ul style="list-style-type: none"> Make sure the door is firmly closed.
	Water valve may be turned off	<ul style="list-style-type: none"> Make sure water valve (usually located under the sink) is turned on.
Stained tub interior	Some tomato-based foods can cause reddish stains	<ul style="list-style-type: none"> Use of the RINSE ONLY cycle after adding the dish to the load can decrease the level of staining. GE recommends Cascade® Plastic Booster to help remove these types of stains.
	Tea or coffee stains	<ul style="list-style-type: none"> Remove the stain by hand, using a solution of 1/2 cup bleach and 3 cups warm water. <p>▲ WARNING Before cleaning interior, wait at least 20 minutes after a cycle for the heating elements to cool down. Failure to do so can result in burns.</p>
	An overall yellow or brown film can be caused by iron deposits in water	<ul style="list-style-type: none"> A special filter in the water supply line is the only way to correct this problem. Contact a water softener company.
White film on inside surface—hard water minerals		<ul style="list-style-type: none"> GE recommends Jet-Dry® or Cascade Crystal Clear® to help prevent hard water mineral deposits from forming. Run dishwasher with citric acid to remove mineral deposits. Citric acid (Part number: WD35X151) can be ordered through GE Parts. See back cover for ordering information.

Before you call for service...



Troubleshooting Tips

Problem	Possible Causes	What To Do
Dishwasher won't run	Fuse is blown or circuit breaker is tripped	<ul style="list-style-type: none"> Replace fuse or reset circuit breaker. Remove any other appliances from the circuit.
	Power is turned off	<ul style="list-style-type: none"> In some installations, the power to the dishwasher is provided through a wall switch, often located next to the disposer switch. Make sure it is on.
	Control panel is locked	<ul style="list-style-type: none"> Unlock control panel. See page 6.
	Control panel needs to be rebooted	<ul style="list-style-type: none"> Turn off power to the dishwasher (circuit breaker or wall switch) for 30 seconds; then turn back on.
Control panel lights go off when you're setting controls	Time too long between touching of selected pads	<ul style="list-style-type: none"> Each pad must be touched within 5 minutes of the others. To relight, touch any pad again, or unlock and relatch door.
Water standing in the bottom of the tub	This is normal	<ul style="list-style-type: none"> A small amount of clean water around the outlet on the tub bottom at the back of the tub keeps the pump seal lubricated.
Water won't pump out of the tub	Drain is clogged	<ul style="list-style-type: none"> If you have an air gap, clean it. See page 15. If the dishwasher drains into a disposer, run disposer clear. Check to see if your kitchen sink is draining well. If not, you may need a plumber.
Steam	This is normal	<ul style="list-style-type: none"> Warm, moist air comes through the vent by the door latch during drying and when water is being pumped out. This is necessary for drying.
Sanitized light does not illuminate at the end of the cycle (Anti-Bacteria cycle only)	<p>The door was opened and the cycle was interrupted during or after the main wash portion</p> <p>The incoming water temperature was too low</p>	<ul style="list-style-type: none"> Do not interrupt the cycle anytime during or after main wash. Raise the water heater temperature to between 120°F and 140°F.
Noise	<p>Normal operating sounds</p> <p>Detergent cup opening</p> <p>Water entering dishwasher</p> <p>The motor stops and starts at various times during the cycle</p> <p>Drain pump sounds during pump out</p> <p>Drying fan running for 2-4 hours after CLEAN light is illuminated (Top Control Panel models only)</p> <p>Rattling dishes when the spray arm rotates</p>	<ul style="list-style-type: none"> These are all normal. No action is required. Make sure dishes are properly loaded. See the <i>Loading the dishwasher racks</i> section.

GE Service Protection Plus™

GE, a name recognized worldwide for quality and dependability, offers you Service Protection Plus™—comprehensive protection on all your appliances—**No Matter What Brand!**

Benefits Include:

- Backed by GE
- All brands covered
- Unlimited service calls
- All parts and labor costs included
- No out-of-pocket expenses
- No hidden deductibles
- One 800 number to call

***We'll Cover Any
Appliance. Anywhere.
Anytime.****

You will be completely satisfied with our service protection or you may request your money back on the remaining value of your contract. No questions asked. It's that simple.

Protect your refrigerator, dishwasher, washer and dryer, range, TV, VCR and much more—**any brand!** Plus there's no extra charge for emergency service and low monthly financing is available. Even icemaker coverage and food spoilage protection is offered. You can rest easy, knowing that all your valuable household products are protected against expensive repairs.

Place your confidence in GE and call us for more information in the U.S.
toll-free at **800.626.2224** and in Canada, toll-free at **888.261.2133**.

*All brands covered, up to 20 years old, in the continental U.S.

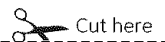

Please place in envelope and mail to:

General Electric Company
Warranty Registration Department
P.O. Box 32150
Louisville, KY 40232-2150

Notes.

Safety Instructions

Operating Instructions

Troubleshooting Tips

Consumer Support

<i>Consumer Support</i>	<i>Troubleshooting Tips</i>	<i>Operating Instructions</i>	<i>Safety Instructions</i>
-------------------------	-----------------------------	-------------------------------	----------------------------

Notes.

GE Dishwasher Warranty.



All warranty service provided by our Factory Service Centers, or an authorized Customer Care® technician. To schedule service, on-line, 24 hours a day, visit us at ge.com, or call 800.GE.CARES (800.432.2737) in the United States. In Canada, call 1.800.361.3400. Please have serial number and model number available when calling for service.

Staple your receipt here.
Proof of the original purchase date is needed to obtain service under the warranty.

For The Period Of: GE Will Replace:

<p>One Year From the date of the original purchase</p>	<p>Any part of the dishwasher which fails due to a defect in materials or workmanship. During this limited one-year warranty, GE will also provide, free of charge, all labor and in-home service to replace the defective part.</p>
<p>Five Years From the date of the original purchase</p>	<p>The dishwasher racks and the electronic control module if they should fail due to a defect in materials or workmanship. During this five-year limited warranty, you will be responsible for any labor or in-home service costs.</p>
<p>Lifetime of Product</p>	<p>The Stainless tub or door liner, if it fails to contain water due to a defect in materials or workmanship. During this limited warranty, GE will also provide, free of charge, all labor and in-home service to replace the defective part.</p>

What GE Will Not Cover (for customers in the United States):

- Service trips to your home to teach you how to use the product.
- Improper installation, delivery or maintenance.
- Failure of the product if it is abused, misused, or used for other than the intended purpose or used commercially.
- Replacement of house fuses or resetting of circuit breakers.
- Product not accessible to provide required service.
- Damage to the product caused by accident, fire, floods or acts of God.
- Incidental or consequential damage caused by possible defects with this appliance.
- Cleaning or servicing of the air gap device in the drain line.
- Damage caused after delivery, including damage from items dropped on the door.

EXCLUSION OF IMPLIED WARRANTIES—Your sole and exclusive remedy is product repair as provided in this Limited Warranty. Any implied warranties, including the implied warranties of merchantability or fitness for a particular purpose, are limited to one year or the shortest period allowed by law.

This warranty is extended to the original purchaser and any succeeding owner for products purchased for home use within the USA. If the product is located in an area where service by a GE Authorized Servicer is not available, you may be responsible for a trip charge or you may be required to bring the product to an Authorized GE Service location for service. Proof of original purchase date is needed to obtain service under the warranty. In Alaska, the warranty excludes the cost of shipping or service calls to your home.

Some states do not allow the exclusion or limitation of incidental or consequential damages. This warranty gives you specific legal rights, and you may also have other rights which vary from state to state. To know what your legal rights are, consult your local or state consumer affairs office or your state's Attorney General.

Warrantor: General Electric Company, Louisville, KY 40225

What Is Not Covered (for customers in Canada):

- Service trips to your home to teach you how to use the product.
- Improper installation.
If you have an installation problem, contact your dealer or installer. You are responsible for providing adequate electrical, exhausting and other connecting facilities.
- Failure of the product if it is abused, misused, or used for other than the intended purpose or used commercially.
- Replacement of house fuses or resetting of circuit breakers.
- Damage to the product caused by accident, fire, floods or acts of God.
- Damage caused after delivery.

EXCLUSION OF IMPLIED WARRANTIES—Your sole and exclusive remedy is product repair as provided in this Limited Warranty. Any implied warranties, including the implied warranties of merchantability or fitness for a particular purpose, are limited to one year or the shortest period allowed by law.

This warranty is extended to the original purchaser and any succeeding owner for products purchased for home use within Canada. In home warranty service will be provided in areas where it is available and deemed reasonable by Mabe to provide.

WARRANTOR IS NOT RESPONSIBLE FOR CONSEQUENTIAL DAMAGES.

Warrantor: MABE CANADA INC.

Consumer Support.



GE Appliances Website

In the U.S.: **ge.com**

Have a question or need assistance with your appliance? Try the GE Appliances Website 24 hours a day, any day of the year! For greater convenience and faster service, you can now download Owner's Manuals, order parts or even schedule service on-line. **In Canada: www.geappliances.ca**

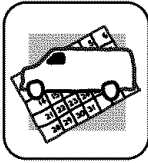

Schedule Service

In the U.S.: **ge.com**

Expert GE repair service is only one step away from your door. Get on-line and schedule your service at your convenience 24 hours any day of the year! Or call 800.GE.CARES (800.432.2737) during normal business hours.

In Canada, call 1.800.361.3400

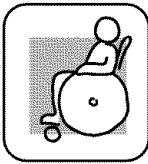

Real Life Design Studio

In the U.S.: **ge.com**

GE supports the Universal Design concept—products, services and environments that can be used by people of all ages, sizes and capabilities. We recognize the need to design for a wide range of physical and mental abilities and impairments. For details of GE's Universal Design applications, including kitchen design ideas for people with disabilities, check out our Website today. For the hearing impaired, please call 800.TDD.GEAC (800.833.4322).

In Canada, contact: Manager, Consumer Relations, Mabe Canada Inc.
Suite 310, 1 Factory Lane
Moncton, N.B. E1C 9M3



Extended Warranties

In the U.S.: **ge.com**

Purchase a GE extended warranty and learn about special discounts that are available while your warranty is still in effect. You can purchase it on-line anytime, or call 800.626.2224 during normal business hours. GE Consumer Home Services will still be there after your warranty expires. **In Canada, call 1.888.261.2133**

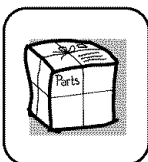

Parts and Accessories

In the U.S.: **ge.com**

Individuals qualified to service their own appliances can have parts or accessories sent directly to their homes (VISA, MasterCard and Discover cards are accepted). Order on-line today, 24 hours every day or by phone at 800.626.2002 during normal business hours.

Instructions contained in this manual cover procedures to be performed by any user. Other servicing generally should be referred to qualified service personnel. Caution must be exercised, since improper servicing may cause unsafe operation.

Customers **in Canada** should consult the yellow pages for the nearest Mabe service center.



Contact Us

In the U.S.: **ge.com**

If you are not satisfied with the service you receive from GE, contact us on our Website with all the details including your phone number, or write to:

General Manager, Customer Relations
GE Appliances, Appliance Park
Louisville, KY 40225

In Canada: www.geappliances.ca, or write to: Director, Consumer Relations, Mabe Canada Inc.
Suite 310, 1 Factory Lane
Moncton, N.B. E1C 9M3



Register Your Appliance

In the U.S.: **ge.com**

Register your new appliance on-line—at your convenience! Timely product registration will allow for enhanced communication and prompt service under the terms of your warranty, should the need arise. You may also mail in the pre-printed registration card included in the packing material. **In Canada: www.geappliances.ca**