

This Owner's Manual is provided and hosted by [Appliance Factory Parts](#).

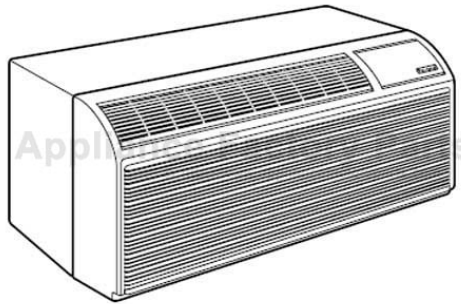

FRIEDRICH PE12K**B Owner's Manual

[Shop genuine replacement parts for FRIEDRICH
PE12K**B](#)



[Find Your FRIEDRICH Air Conditioner Parts - Select From 1575 Models](#)

----- Manual continues below -----



Parts Manual

Wall Master®

Packaged Terminal Air Conditioner
B Suffix Models

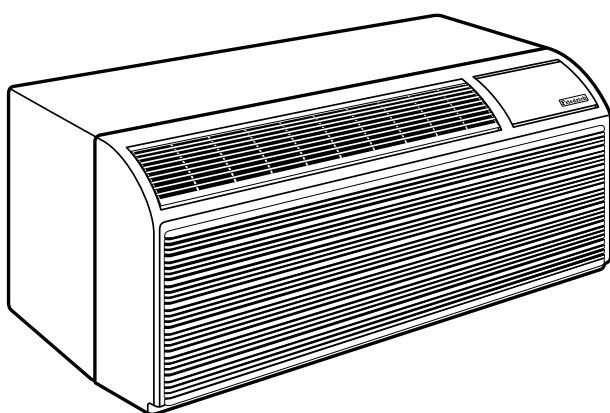

MODELS

PE07K**B

PE07R**B

PE09K**B

PE09R**B

PE12K**B

PE12R**B

PE15K**B

PE15R**B

PH07K**B

PH07R**B

PH09K**B

PH09R**B

PH12K**B

PH12R**B

PH15K**B

PH15R**B

Table of Contents

PTAC Model Number Identification Guide.....	3
PTAC Serial Number Identification Guide	3
Unit Assembly Drawing	4
Unit Assembly Parts List.....	5
Air Handler	6
Air Handler Parts List	7
Control Box Assembly	8
Control Box Parts List.....	9
Front Cover Assembly Drawing.....	10
Front Cover Parts List	10
Notes	11

UNIT IDENTIFICATION

Model Number Code

P H 07 K 3 S B 1

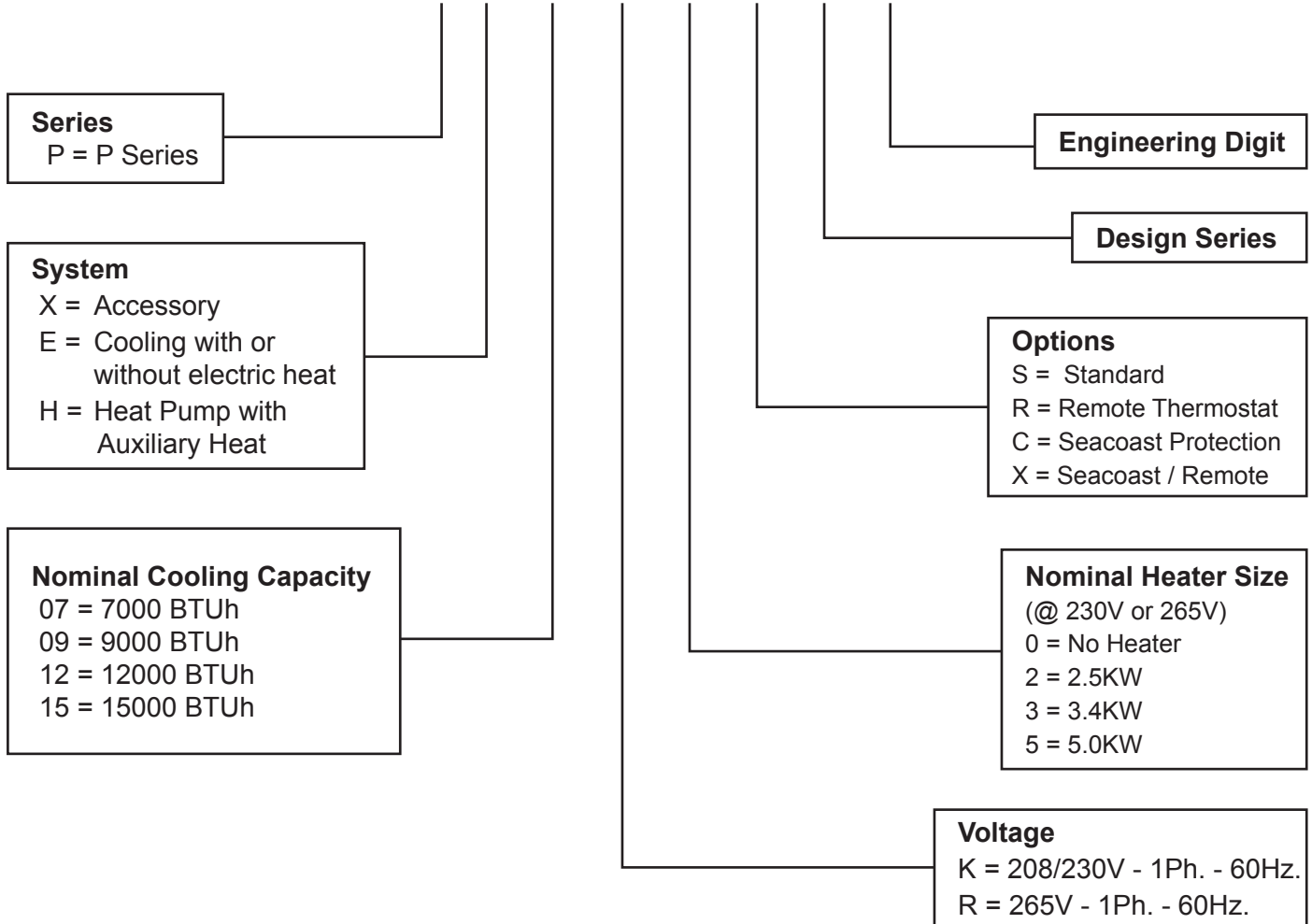

PTAC Serial Number Identification Guide					
Serial Number	L	C	M	P	00000 Production Run Number
Decade Manufactured	Product Line R = RAC P = PTAC E = EAC V = VPAK H = DSS				
L = 0 C = 3 F = 6 J = 9 A = 1 D = 4 G = 7 B = 2 E = 5 H = 8					
Year Manufactured					
A = 1 C = 3 E = 5 G = 7 J = 9 B = 2 D = 4 F = 6 H = 8 K = 0					
Month Manufactured					
A = Jan D = Apr G = Jul K = Oct B = Feb E = May H = Aug L = Nov C = Mar F = Jun J = Sep M = Dec					

UNIT ASSEMBLY

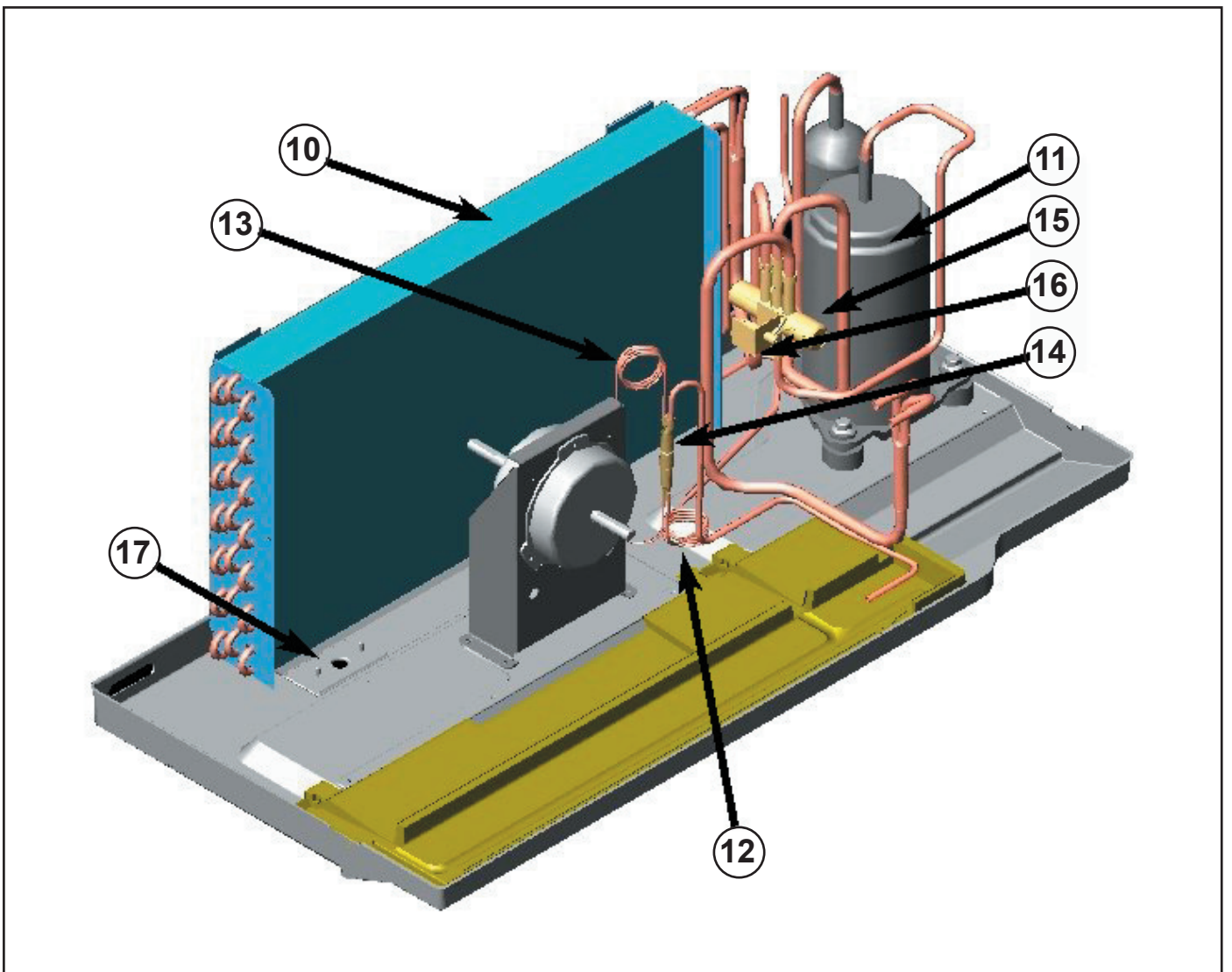

REF.	PART NO.	DESCRIPTION	07	09	12	15	NOTES
N/S	25059400	Coil, Indoor	1	1	1	–	
N/S	25065000	Coil, Indoor	–	–	–	1	
10	25014820	Coil, Outdoor	1	1	1	1	
10	25014821	Coil, Outdoor	1	1	1	1	Seacoast
10	25064800	Coil, Outdoor- Heat Pump Only	–	–	–	1	
10	25064801	Coil, Outdoor- Heat Pump Only	–	–	–	1	Seacoast
11	25024915	Compressor, 230 Volt	1	–	–	–	
11	25024908	Compressor, 230 Volt	–	1	–	–	
11	25024907	Compressor, 230 Volt	–	–	1	–	
11	25024910	Compressor, 230 Volt	–	–	–	1	
11	25024914	Compressor, 265 Volt	1	–	–	–	
11	25024913	Compressor, 265 Volt	–	1	–	–	
11	25024912	Compressor, 265 Volt	–	–	1	–	
11	25024911	Compressor, 265 Volt	–	–	–	1	
12	03760548	Cap Tube A/C-Electric Only	1	–	–	–	
12	03760547	Cap Tube A/C-Electric Only	–	1	–	–	
12	03760511	Cap Tube A/C-Electric Only	–	–	1	–	
12	01389985	Cap Tube A/C-Electric Only	–	–	–	1	
12	03760547	Cap Tube, Cooling, Heat Pump	1	–	–	–	
12	03760547	Cap Tube, Cooling, Heat Pump	–	1	–	–	
12	01390000	Cap Tube, Cooling, Heat Pump	–	–	1	–	
12	01389975	Cap Tube, Cooling, Heat Pump	–	–	–	1	
13	03760473	Cap Tube, Heating, Heat Pump	1	–	–	–	
13	03760547	Cap Tube, Heating, Heat Pump	–	1	–	–	
13	01389975	Cap Tube, Heating, Heat Pump	–	–	1	–	
13	01389985	Cap Tube, Heating, Heat Pump	–	–	–	1	
14	25057200	Check Valve	1	–	–	–	
14	25057201	Check Valve	–	1	1	1	
15	25022010	Reversing Valve Kit	1	1	–	–	
15	25022020	Reversing Valve Kit	–	–	1	1	
16	25022050	Solenoid Coil Kit 230 Volt	1	1	1	1	
16	25022060	Solenoid Coil Kit 265 Volt	1	1	1	1	
17	60179903	Condensate Valve (bellows type)	1	1	1	1	
N/S	61764537	Overload Compressor 230 Volt	1	–	–	–	
N/S	61764535	Overload Compressor 230 Volt	–	1	–	–	
N/S	61764521	Overload Compressor 230 Volt	–	–	1	–	
N/S	61764532	Overload Compressor 230 Volt	–	–	–	1	
N/S	61764543	Overload Compressor 265 Volt	1	–	–	–	
N/S	61764542	Overload Compressor 265 Volt	–	1	–	–	
N/S	61764541	Overload Compressor 265 Volt	–	–	1	–	
N/S	61764538	Overload Compressor 265 Volt	–	–	–	1	

AIR HANDLER

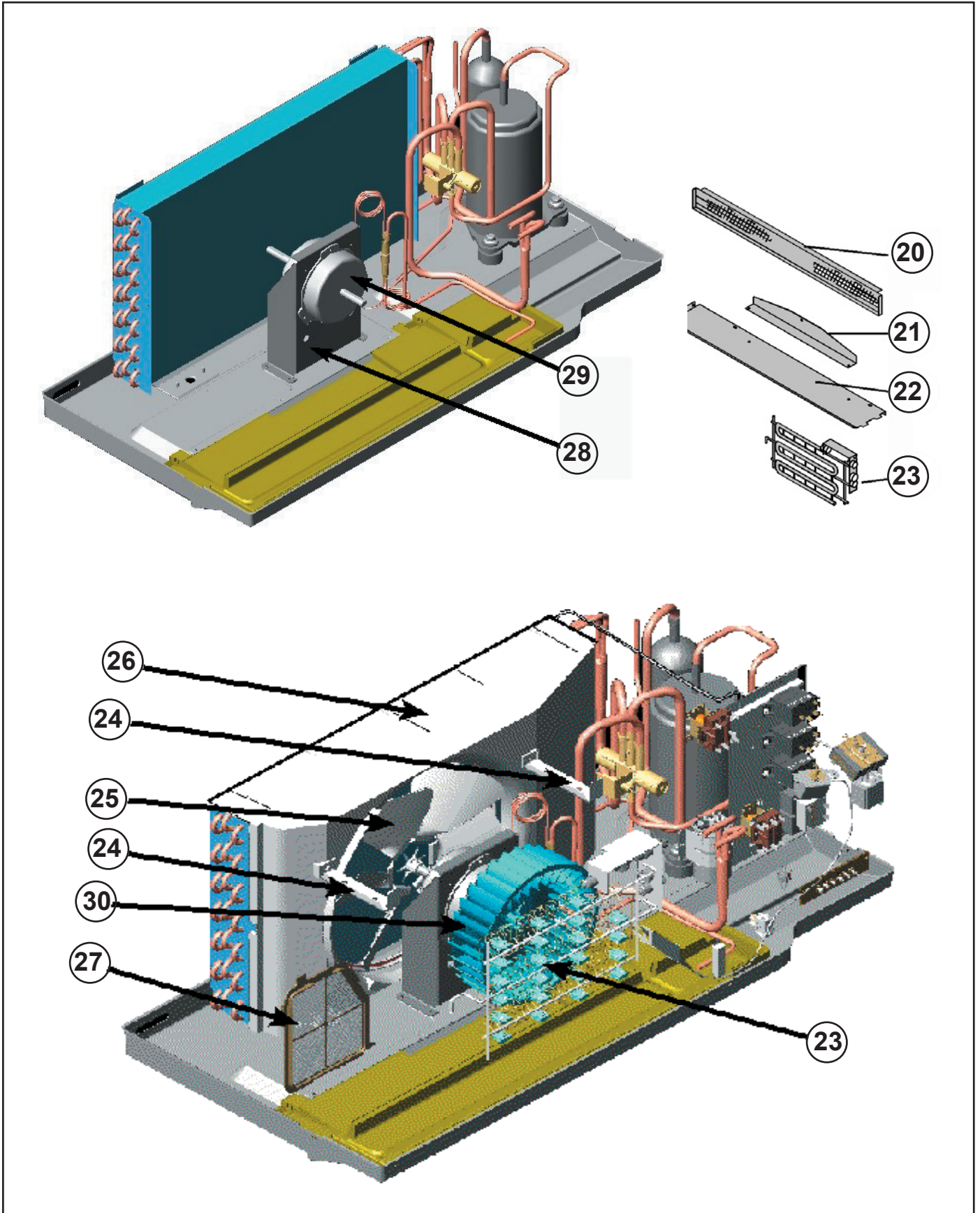

REF.	PART NO.	DESCRIPTION	07	09	12	15	NOTES
20	25038400	Discharge Screen	1	1	1	1	
21	25048300	Air Deflector	1	1	1	1	
22	25016001	Deck	1	1	1	1	
23	25068000	Kit,Heater 2.5 kW @ 230 Volt	1	1	1	1	
23	25068001	Kit,Heater 3.4 kW @ 230 Volt	1	1	1	1	
23	25068004	Kit,Heater 5.0 kW @ 230 Volt	1	1	1	1	
23	25068002	Kit,Heater 2.5 kW @ 265 Volt	1	1	1	1	
23	25068003	Kit,Heater 3.4 kW @ 265 Volt	1	1	1	1	
23	25068005	Kit,Heater 5.0 kW @ 265 Volt	1	1	1	1	
24	25036400	Support Brace (condenser)	1	1	1	1	
25	60542006	Condenser slinger blade	1	1	1	1	
26	25036801	Condenser Shroud	1	1	1	1	
27	25015300	Fresh Air Door Screen	1	1	1	1	
27	25034900	Fresh Air Door Insulation	1	1	1	1	
28	25014400	Motor Mount Bracket	1	1	1	1	
29	25014600	Motor, 230 Volt 1/15 HP 2P	1	1	-	-	
29	25014610	Motor, 230 Volt 1/10 HP 2P	-	-	1	1	
29	25014601	Motor, 265 Volt 1/15 HP 2P	1	1	-	-	
29	25014611	Motor, 265 Volt 1/10 HP 2P	-	-	1	1	
30	Use Htr Kit	Blower Wheel	1	1	1	1	
N/S	25014300	Scroll 7-9	1	1	-	-	
N/S	25014305	Scroll 12-15	-	-	1	1	
N/S	60217902	Seal, Motor to Wall	1	1	1	1	
N/S	25015900	Fresh Air Door Latch	1	1	1	1	
N/S	25045100	Fresh Air Door Cable	1	1	1	1	
N/S	Use Htr Kit	Limit Switch 2.5 kW @ 230	1	1	1	1	
N/S	Use Htr Kit	Limit Switch 3.4 kW @ 230	1	1	1	1	
N/S	Use Htr Kit	Limit Switch 5.0 kW @ 230	1	1	1	1	
N/S	Use Htr Kit	Limit Switch 2.5 kW @ 265	1	1	1	1	
N/S	Use Htr Kit	Limit Switch 3.4 kW @ 265	1	1	1	1	
N/S	Use Htr Kit	Limit Switch 5.0 kW @ 265	1	1	1	1	
N/S	Use Htr Kit	Fuse Link 2.5 kW @ 230	1	1	1	1	
N/S	Use Htr Kit	Fuse Link 3.4 kW @ 230	1	1	1	1	
N/S	Use Htr Kit	Fuse Link 5.0 kW @ 230	1	1	1	1	
N/S	61828200	Suction Dryer	1	1	1	1	
N/S	60308101	Liquid line Dryer (not for heat pump)	1	1	1	1	Cooling Only
N/S	25065700	Jumper, Heater	1	1	1	1	

CONTROL BOX ASSEMBLY

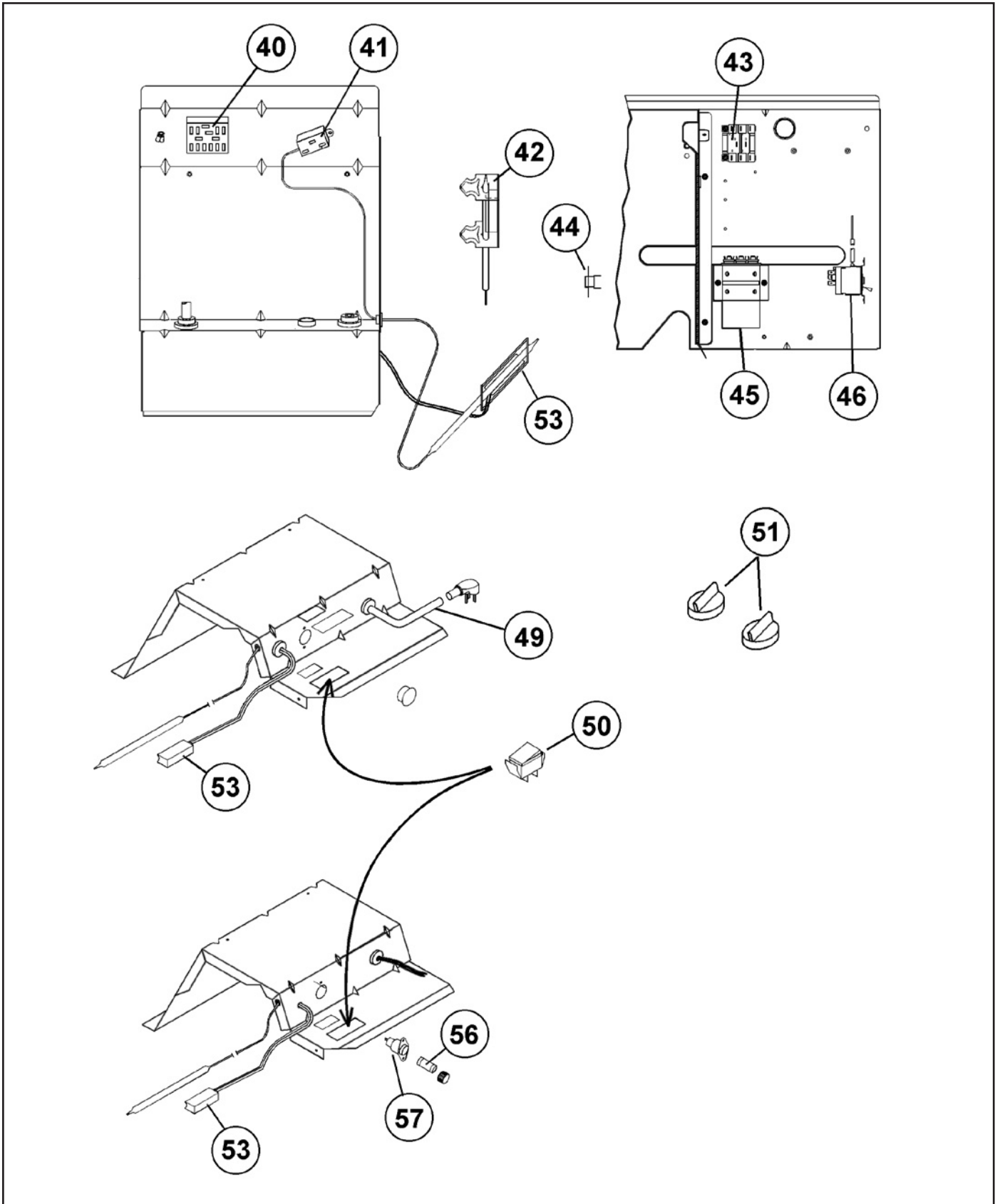

REF.	PART NO.	DESCRIPTION	07	09	12	15	NOTES
40	25038201	Switch, Cooling and Heating	1	1	1	1	
40	25038301	Switch, cooling Only	1	1	1	1	
41	25043300	Thermostat, Indoor	1	1	1	1	
42	61900500	Retainer Clip, for Thermostat Bulb	1	1	1	1	
43	21091127	Hot Start Relay (230 Volt) DPST	1	1	1	1	Heat Pump
43	21091155	Hot Start Relay (265 Volt) DPST	1	1	1	1	Heat Pump
43	21060940	Hot Start Relay (24 Volt) DPST	1	1	1	1	Remote HP
44	25039101	Sensor, Hot Start	1	1	1	1	Heat Pump
45	61080541	Capacitor, 20/5 @ 370 (230 Volt)	1	-	-	-	
45	61080573	Capacitor, 15/5 @ 440 (265 Volt)	1	-	-	-	
45	61080539	Capacitor, 25/5 @ 370 (230 Volt)	-	1	-	-	
45	61080571	Capacitor, 20/5 @ 440 (265 Volt)	-	1	-	-	
45	61080565	Capacitor, 30/5 @ 370 (230 Volt)	-	-	1	-	
45	61080571	Capacitor, 20/5 @ 440 (265 Volt)	-	-	1	-	
45	61080565	Capacitor, 30/5 @ 370 (230 Volt)	-	-	-	1	
45	61080571	Capacitor, 20/5 @ 440 (265 Volt)	-	-	-	1	
46	25039900	Thermostat, Defrost	1	1	1	1	Heat Pump
49	21058582	Cord, 15 A (2.5kW @ 230 Volt)	1	1	1	1	
49	21058583	Cord, 20 A (3.4kW @ 230 Volt)	1	1	1	1	
49	21058584	Cord, 30 A (5.0kW @ 230 Volt)	1	1	1	1	
50	25001900	Rocker Switch	1	1	1	1	
51	25043400	Knob, Control	1	1	1	1	
53	25043900	Heat Anticipator (230 Volt)	1	1	1	1	
53	25043900	Heat Anticipator (265 Volt)	1	1	1	1	
56	21058448	Fuse, Time Delay 15 AMP (2.5kW)	1	1	1	1	265 Volt
56	21058449	Fuse, Time Delay 20 AMP (3.4kW)	1	1	1	1	265 Volt
56	21058451	Fuse, Time Delay 30 AMP (5.0kW)	1	1	1	1	265 Volt
57	21058444	Fuse Holder 15 AMP (2.5kW)	1	1	1	1	265 Volt
57	21058446	Fuse Holder 20 Amp (3.4kW)	1	1	1	1	265 Volt
57	21058447	Fuse Holder 30 AMP (5.0kW)	1	1	1	1	265 Volt
N/S	25043201	Terminal board, Low Voltage	1	1	1	1	Remote
N/S	25042500	Relay, DPST (NO) 24V Heat Relay	1	1	1	1	Remote HP
N/S	21053004	Relay, SPST 24V Fan/RV/Cooling	1	1	1	1	Remote HP
N/S	25042501	Relay, DPST (NC) 24V Desk Cont.	1	1	1	1	Desk Cont.
N/S	21056899	Transformer, (230 Volt)	1	1	1	1	Remote
N/S	21091226	Transformer, (265 Volt)	1	1	1	1	Remote
N/S	60603900	Suction Line Thermostat	1	1	1	1	Remote

FRONT COVER

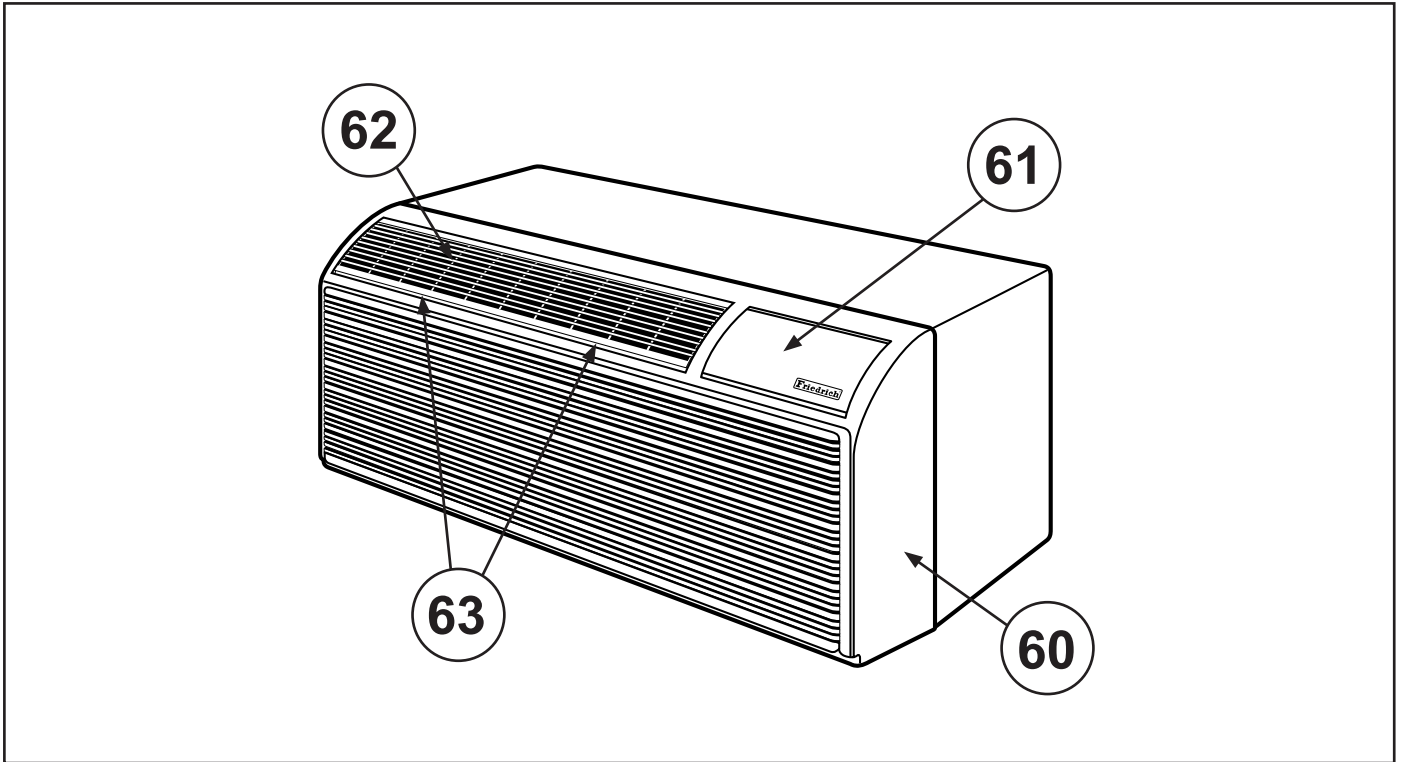

Front Cover Parts

Key	Part Number	Description	07	09	12	15	Notes
60	25037900	Front Cover Complete (Includes Door and Filters)	1	1	1	1	
61	25031900	Control Door	1	1	1	1	
62	25025901	Grille, Discharge	1	1	1	1	
63	25037800	Filter	2	2	2	2	
N/S	25060600	Thumb Screw	2	2	2	2	
N/S	25060500	Speed Nut (U-Type)	2	2	2	2	

Notes

Use Factory Certified Parts.



FRIEDRICH AIR CONDITIONING CO.

Post Office Box 1540 · San Antonio, Texas 78295-1540
4200 N. Pan Am Expressway · San Antonio, Texas 78218-5212
(210) 357-4400 · FAX (210) 357-4480
www.friedrich.com

Printed in the U.S.A.

PTACPRTS-B Revised (12-03)