

This Owner's Manual is provided and hosted by [Appliance Factory Parts](#).

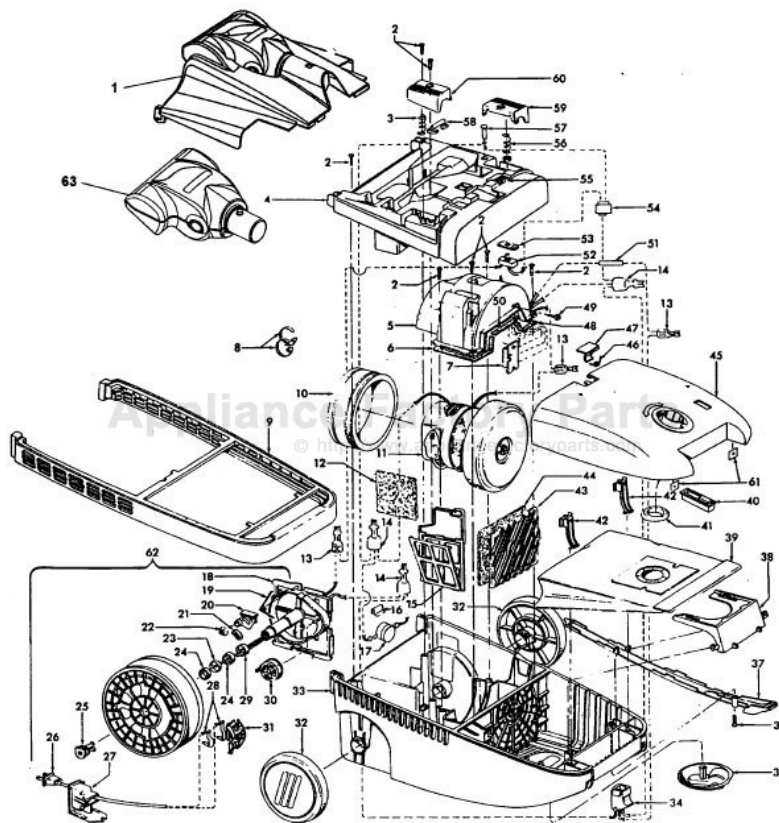

HOOVER S3649 Owner's Manual

[Shop genuine replacement parts for HOOVER S3649](#)



[Find Your HOOVER Vacuum Cleaner Parts - Select From 1456 Models](#)

----- Manual continues below part list -----

Available Replacement Parts for HOOVER S3649

HR-1489	HOOVER MICRO FILTER BAG 3 PACK
H-38528036	BELT, FLAT 1PK
H-34174012	FILTER, EXHAUST, 1PK
H-43414073	Floor brush.
H-43414064	DUSTING BRUSH (ONE PEICE)
H-38765009	SECONDARY FILTER
HR-5000	EXTENSION TUBE

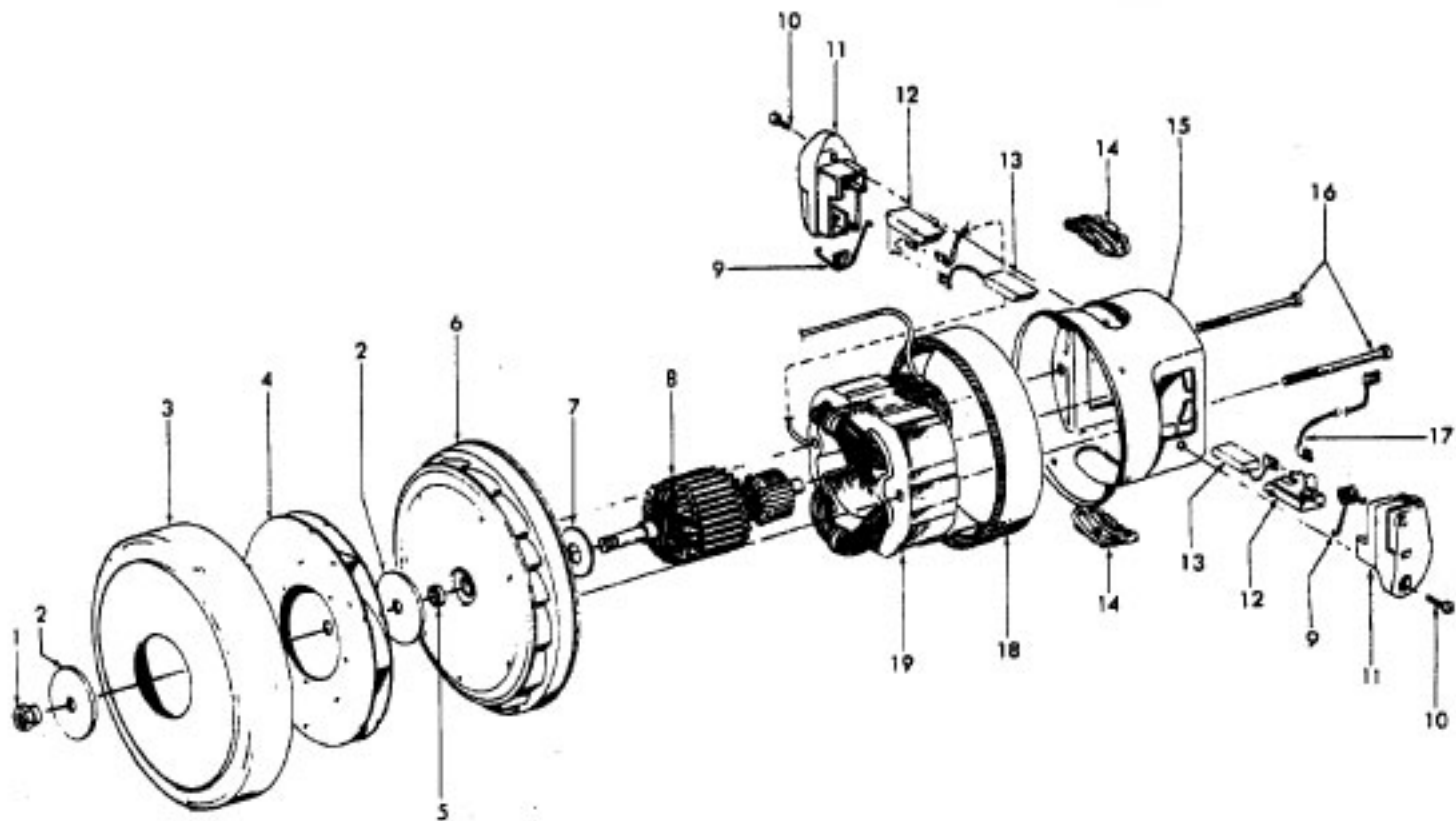

Ref. No.	Part No.	Description
	43576184	Motor Assem. (Molded Diffuser)
	43576192	Motor Assem. - S3630, S3639, S3646, S3646-020, S3649, S3655, S3661
1	12028--	Nut
2	21312774	Washer - FW (2)
3	37196065	Fan Cover
4	43551008	Fan
5	31148009	Bearing Spacer (Use w/Die Cast Diffuser)
	31148011	Bearing Spacer (Use w/Molded Diffuser)
6	43551029	Diffuser Assem. Comp. (Molded)
7	31165003	Bearing Retainer Plate (Die Cast Diffuser)
8	44765138	Armature Assem.
	44765241	Armature Assem. - S3630, S3646, S3655
9	38353004	Spring (2)
10	21429406	Screw (2)
11	167696AG	Brush Carrier (2)

Ref. No.	Part No.	Description
12	N/A	Brush Holder (2) - Use Brush Carrier Assem. 47318008 (Incl. It. 9, 11, 12, 13)
13	167681	Motor Brush Assem. (2)
	47315011	Motor Brush Assem. (2) - S3630, S3646, S3655
14	169702BZ	Bushing (2)
15	42193025	Motor Housing Assem.
16	36112006	Field Lamination Bolt (2) (Die Cast Diffuser)
	21447222	Field Lamination Bolt (2) (Phenolic Diffuser)
	21479573	Screw (2) - S3630, S3646, S3655
17	46176001	Lead Wire Assem.
18	36322031	Motor Gasket
19	45311051	Field Assem.

PowerNozzle 48438197 - S3630 - ABM 48438204 - S3646, S3646-020 - AG 48438104 - S3640 - ACM
 48438204 - S3649, S3655, S5711, S5713 - AG 48438198 - S3639 - ADJ
 48438208 - S3661 - ACL 48438268 - S3636-050- AAY 48438273- AG-S5686, S5688

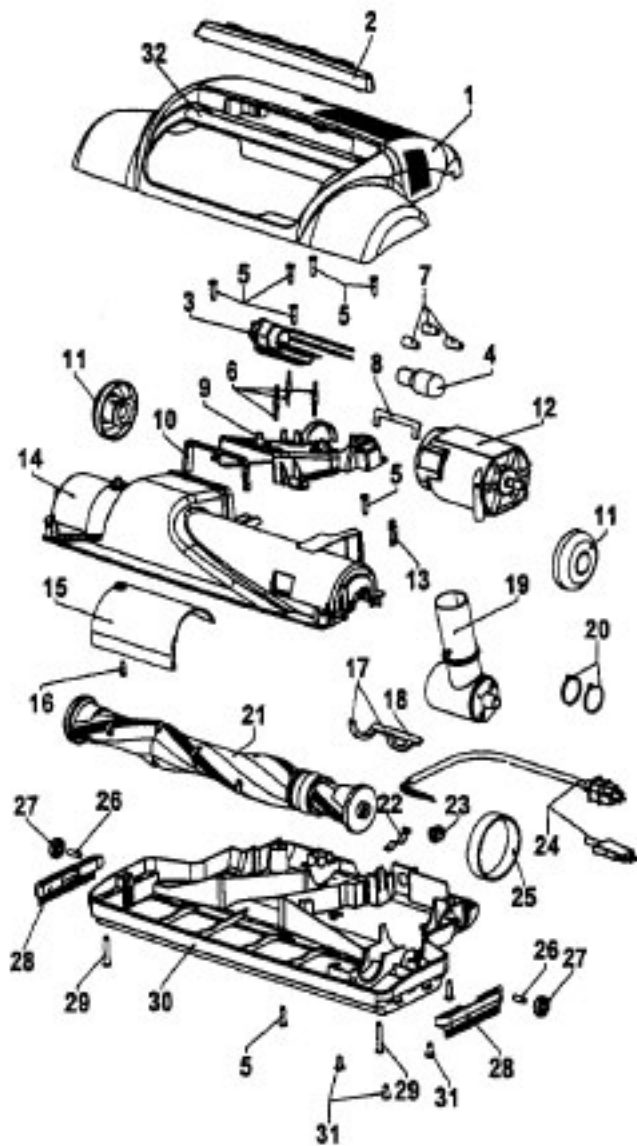

Ref. No.	Part No.	Description
1.	Note: All Hoods include item 2	
	37253310	Hood - S3630
	37253311	Hood - S3646, S3646-020, S3649, S3655, S5711, S5713 S5686, S5688
	37253314	Hood - S3640
	37253330	Hood - S3639
	37253331	Hood - S3661
	37253332	Hood - S3636-050
2.	39383105	Lens
3.	47171020	Dirt Finder Socket Assembly
4.	27317307	Dirt Finder Bulb
5.	21447003	Screw - 8 required
6.	36218016	Grommet - 3 required
7.	27618508	Wire Connector - 3 required
8.	34253018	Rear Seal
9.	37243031	Duct Cover
10.	34113008	Seal
11.	43244043	Wheel / Axle Assembly - 2 required
12.	43177062	Motor Assembly
13.	013261AY	Rib Shoe
14.	37243029	Agitator Cover Assembly - (Inc. items 13, 15, 16) See note
15.	37243030	Duct Cover
16.	21479449	Screw
17.	34122014	Seal - 2 required
18.	34112007	Seal
19.	43482106	Nozzle Connector
20.	27479307	Cable Tie - 2 required
21.	48414084	Agitator Assembly
22.	35276008	Detent Spring
23.	163768--	Strain Relief
24.	46521021	Power Nozzle Cord - 3 wire
	46321105	Cord - 2 wire - S5686, S5688
25.	38528036	Belt
26.	31522004	Wheel Shaft
27.	32761001	Wheel
28.	39511004	Litter Picker - 2 required
29.	21447236	Screw - 2 required
30.	37245053	Base Plate - (Includes items 26, 27, 28) See note
31.	21479801	Screw - 3 required
32.	51669082	Nameplate - S3630, S3640
	51669083	Nameplate - S3655, S5711, S5713, S5686, S5688
	N/A	Nameplate - S3639, S3646, S3646-020, S3649, S3661
	51659042	Hood Nameplate - S3636-050

Note: Does not include pulley seals. Order part number 38781053.

Hose Assembly - PowerMAX/TurboPOWER/ WindTunnel

Models S3603, S3603-040, S3609,
S3610, S3613, S3614, S3630, S3639,
S3640, S3646, S3646-020, S3636-050

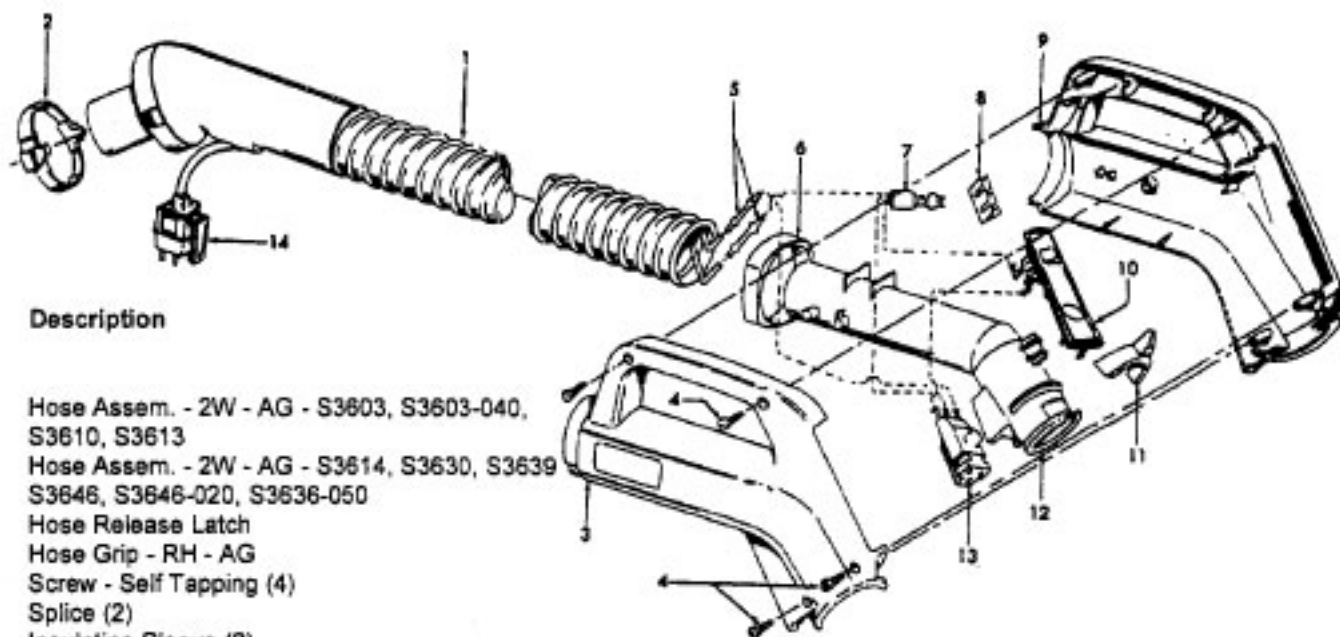





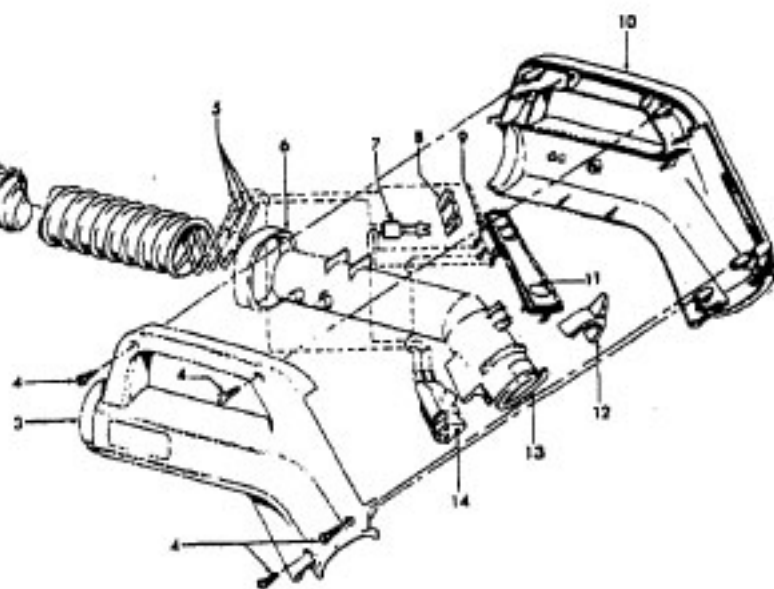



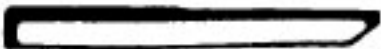

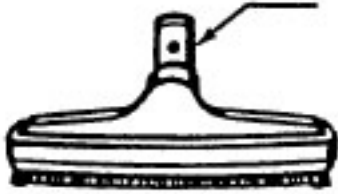
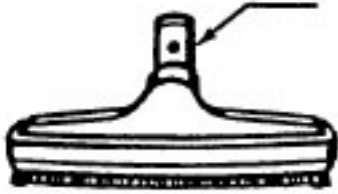

Ref. No.	Part No.	Description
1	43433110	Hose Assem. - 2W - AG - S3603, S3603-040, S3610, S3613
	43433116	Hose Assem. - 2W - AG - S3614, S3630, S3639, S3646, S3646-020, S3636-050
2	36153038	Hose Release Latch
3	39461018	Hose Grip - RH - AG
4	21447124	Screw - Self Tapping (4)
5	27613002	Splice (2)
	31712006	Insulating Sleeve (2)
6	36131087	Retaining Ring - ABR
7	18972	Insulated Terminal
8	36913030	Insulator
9	39461017	Hose Grip - LH - AG
10	47551011	Grip Control Panel Assem.
	47551031	Grip Control Panel Assem. (Inc. items 7, 13)
	51375132	Nameplate - Grip Control Panel
11	36153029	Latch Ring -AG
12	38646081	Inner Tube - AG
13	46526004	Connector - BZ
14	36152029	Plug Latch - AG
	40300051	Cord Repair Kit - 2W

Ref. No.	Part No.	Description
1	43433098	Hose Assem. - 3W - S3640
2	36153038	Hose Release Latch
3	39461016	Hose Grip - RH - ABR
4	21447124	Screw - Self Tapping (4)
5	27613002	Splice (3)
	31712006	Insulating Sleeve (3)
6	36131087	Retaining Ring - ABR
7	18972	Insulated Terminal
8	36913030	Insulator
9	28267001	Switch
10	39461015	Hose Grip - LH - ABR
11	47551013	Grip Control Panel Assem. (Incl. Items 7,9)
	51375133	Nameplate - Grip Control Panel
12	36153029	Latch Ring - AG
13	38646034	Inner Tube - AG
14	46526004	Connector
15	36152029	Plug Latch - AG
	40300052	Cord Repair Kit - 3W

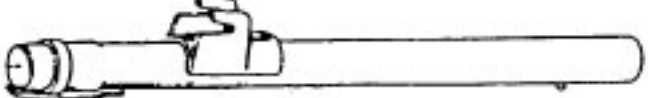

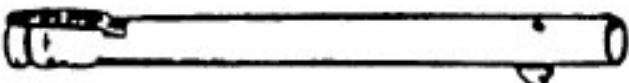
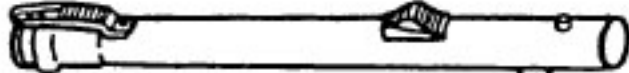
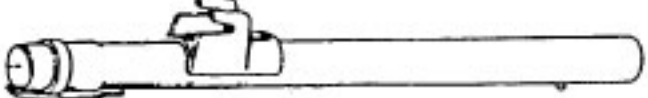
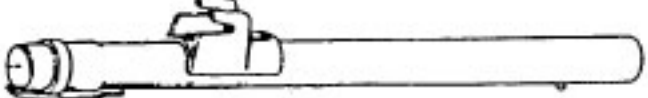
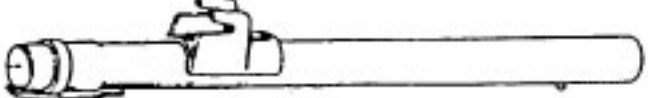
Cleaning Tools - Futura, Spectrum, Dimension, WindTunnel

	38617017	Crevice Tool - AG
	43414057	Furniture Nozzle - AG
	43414141	Furniture Nozzle - ABR
	43414064	Dusting Brush - AG
	38644020	Swivel Connector - AG
	38644040	Swivel Connector - AAP
	43414073	Floor Brush - AG
	48447001	+ Brush Back
	36172584	Cord/Wand Clip
	43453052	Ext. Tube - 20 - AX
	43453027	Ext. Tube
	43453058	+ Ext. Tube - BL 20 w/o Cord Clip
	43453023	Ext. Tube - AX 20
	43453095	Ext. Tube - AX 20 (Black Storage Clip) (Spectrum)
	43453098	Ext. Tube - AX 20 (Gray Storage Clip) (Futura)
	43453099	Ext. Tube - AX 20 (Black Storage Clip) (WindTunnel Canister)
	3863801P	Extension Tube - Poly - AG

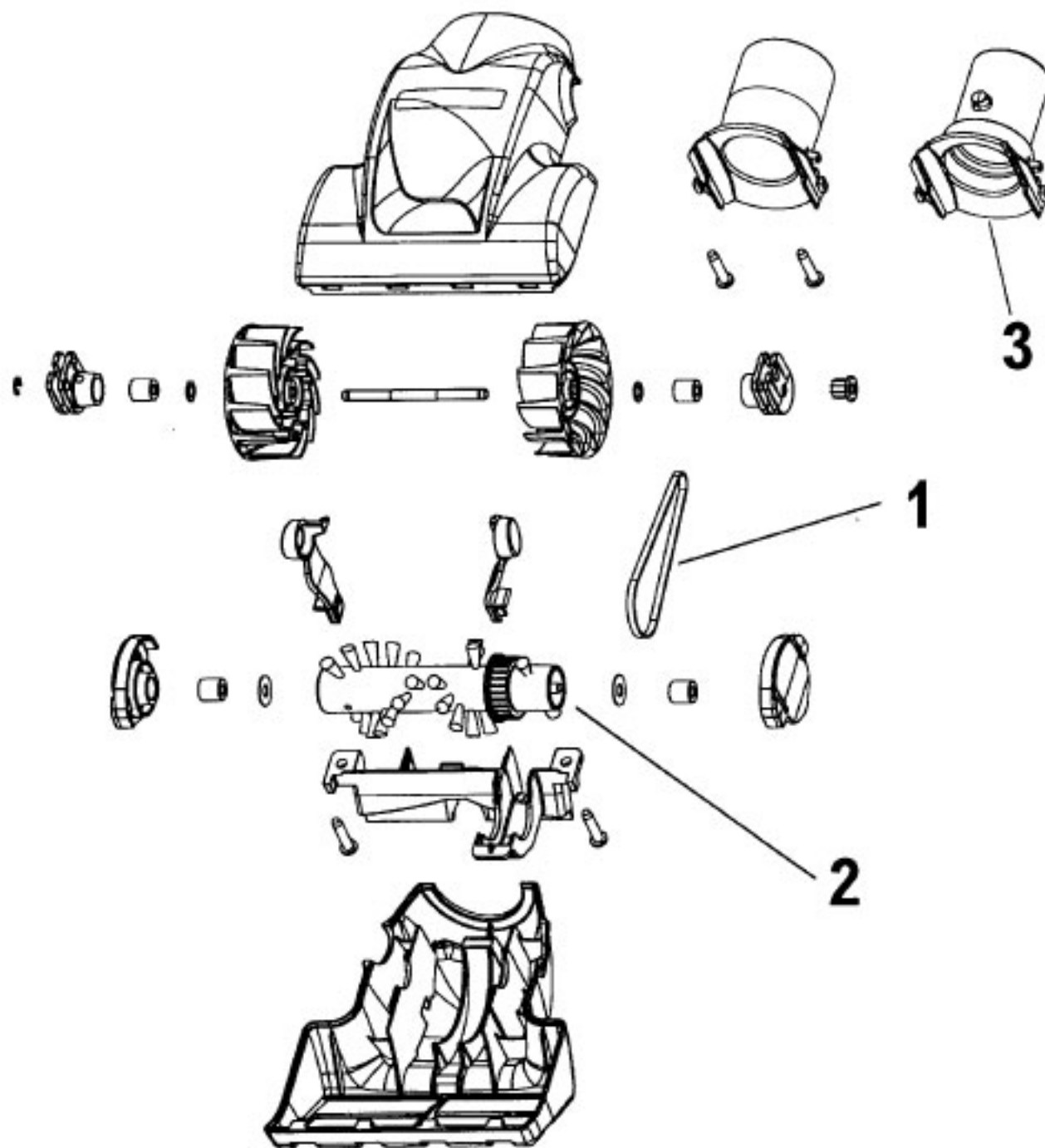

Ref: No.	Part No.	Description
	49129008	Turbine Driven Hand Tool Complete-Sapphire - S3639, S3649
	49129009	Turbine Driven Hand Tool Complete - Dark Spruce - S3661
1	38528037	Belt
2.	48414088	Agitator Assembly
3.	38632012	Connector