

This Owner's Manual is provided and hosted by [Appliance Factory Parts](#).

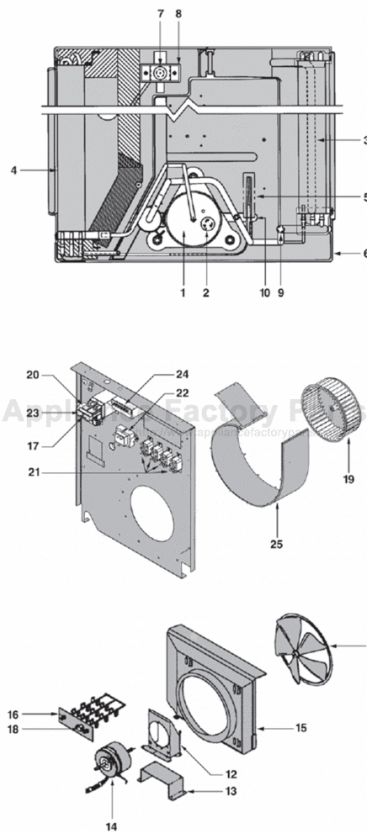

FRIEDRICH VHA12K25**E Owner's Manual

[Shop genuine replacement parts for FRIEDRICH
VHA12K25**E](#)



[Find Your FRIEDRICH Air Conditioner Parts - Select From 1575 Models](#)

----- Manual continues below -----

Friedrich®

Parts Manual

VERT-I-PAK® A SERIES

Single Package
Vertical Air Conditioning System
E Suffix Models

MODELS

V(E,H)A09K25**E	V(E,H)A09K34**E	V(E,H)A09K50**E
V(E,H)A12K25**E	V(E,H)A12K34**E	V(E,H)A12K50**E
V(E,H)A18K25**E	V(E,H)A18K34**E	V(E,H)A18K25**E

VERT-L-PAK® Model Number Identification Guide

MODEL NUMBER	V	E	A	09	K	50	RT	E (Suffix)
SERIES V = Vertical Series E = Cooling with or without electric heat H = Heat Pump								
DESIGN SERIES								ENGINEERING CODE
NOMINAL CAPACITY 09 = 9,000 Btuh 12 = 12,000 Btuh 18 = 18,000 Btuh								CONTROL RT = Remote Thermostat SP = Seacoast Protected
VOLTAGE K=208/230V-1Ph-60Hz R=265V-1Ph-60Hz								ELECTRIC HEATER SIZE (Nominal KW size) 00 = no elect. heat 25 = 2.5KW 34 = 3.4KW 50 = 5.0KW

VERT-L-PAK® Serial Number Identification Guide

SERIAL NUMBER	L	B	A	V	00001
Decade Manufactured J = 9 K = Not Used L = 0					PRODUCTION RUN NUMBER
YEAR MANUFACTURED A = 1 E = 5 J = 9 B = 2 F = 6 K = 0 C = 3 G = 7 D = 4 H = 8					PRODUCT LINE R = RAC P = PTAC E = EAC V = VPAK H = SPLIT
MONTH MANUFACTURED A = Jan D = Apr G = Jul K = Oct B = Feb E = May H = Aug L = Nov C = Mar F = Jun J = Sep M = Dec					

This document reflected an accurate listing of parts and information at the time of its publication. Our policy of continuously upgrading and improving our products makes it impossible to keep it up to date. Your Friedrich dealer, his supplier and the Customer Service Department at Friedrich will have the latest information should problems arise. Please contact us.

VERT-I-PAK[®] Electrical Component Layout

- 1- Quick Disconnect
- 2- Capacitor
- 3- Defrost Thermostat
- 4- Transformer
- 5- Cool Relay
- 6- Fan Relay
- 7- Heat 1 Relay - Electric Strip
- 8- Heat 2 - Reversing Valve
- 9- Electric Strip Heater
- 10- Thermostat Terminal Block

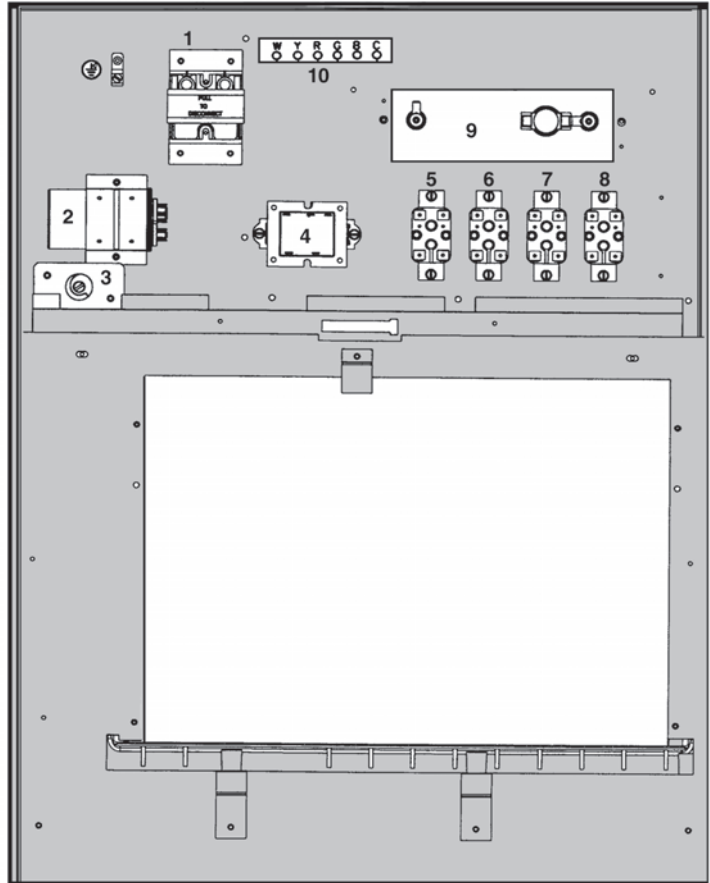

VERT-I-PAK[®] Components

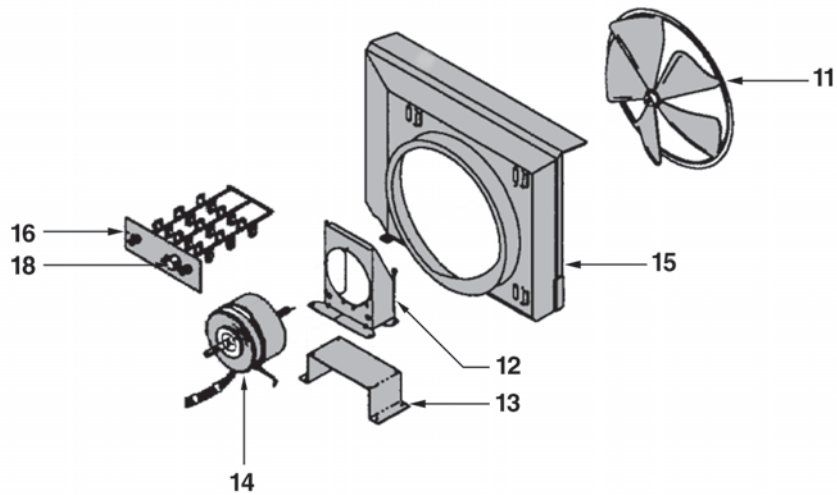
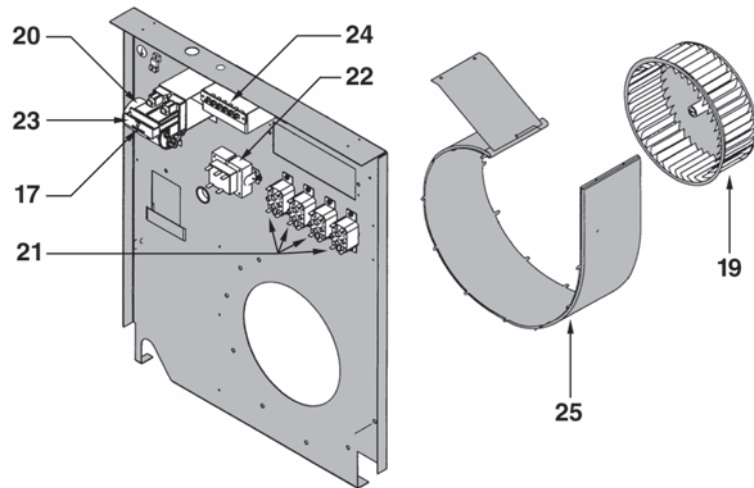
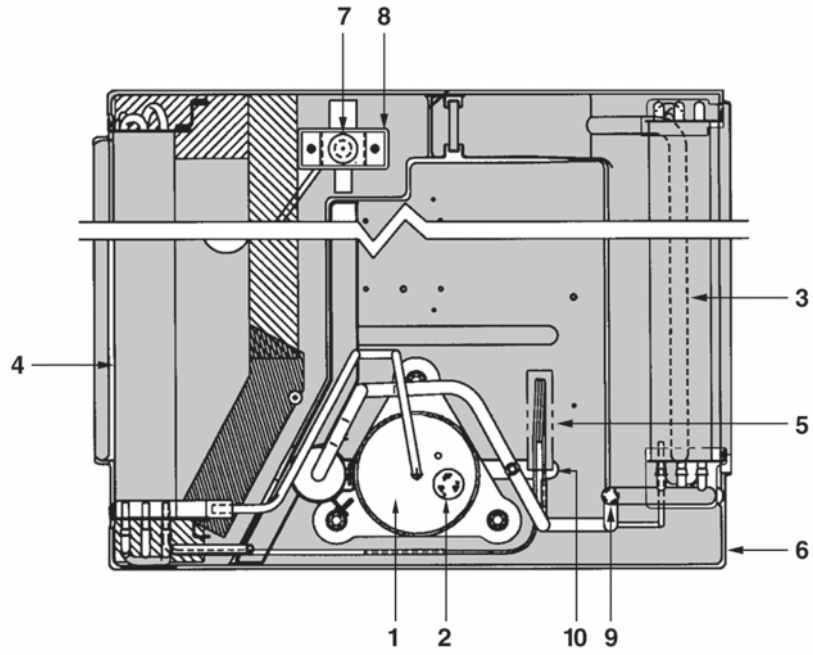

Key	Part #	Description	09 E	12 E	18 E	Notes
1	250-249-02	Compressor	1			
1	250-249-09	Compressor		1		
1	250-249-05	Compressor			1	
2	615-780-01	Overload	1			
2	603-645-96	Overload		1		
2	617-645-22	Overload			1	
3	618-501-07	Indoor Coil Assy.	1	1		
3	618-501-05	Indoor Coil Assy.			1	
4	618-503-17	Outdoor Coil Assy.	1	1		
4	618-502-18	Outdoor Coil Assy.			1	
4	618-503-18	Outdoor Coil Assy. Condenser (*See notes)	1	1		Sea Coast
4	618-502-19	Outdoor Coil Assy. Condenser (*See notes)			1	Sea Coast
5	037-605-11	Tube, Capillary, Cooling	1	1		Heat Pump
5	037-605-18	Tube, Capillary, Cooling			2	Heat Pump
5	037-605-18	Tube, Capillary, Heating	1			Heat Pump
5	037-605-20	Tube, Capillary, Heating		1		Heat Pump
5	013-902-23	Tube, Capillary, Heating			1	Heat Pump
5	037-605-18	Tube, Capillary, Cooling			2	Electric Heat
6	800-237-00	Base pan	1	1	1	
7	601-799-00	Bellows, Condensate Valve	1	1	1	
8	800-228-00	Bracket, Bellows	1	1		
8	800-228-01	Bracket, Bellows			1	
9	210-590-23	Suction Freeze Protection Device	1	1	1	
10	210-585-68	Check Valve	1			
10	210-585-67	Check Valve		1		
10	650-135-00	Check Valve			1	
11	605-420-03	Fan, Plastic 13"	1	1		
11	605-420-04	Fan, Plastic 14.5"			1	
12	617-769-00	Motor Mount Asy	1	1	1	
13	800-067-02	Riser, Motor Mount	1	1		
13	800-067-01	Riser, Motor Mount			1	
14	800-068-01	Motor 1/4 1 6p CCW	1	1	1	
15	618-049-00	Shroud Medium			1	
15	618-036-01	Shroud Small.	1	1		
16	800-170-00	Heater 2.5 KW 230V	1	1	1	
16	800-170-01	Heater 3.4 KW 230V	1	1	1	
16	800-170-02	Heater 5.0 KW 230V	1	1	1	
17	250-111-00	Defrost Thermostat	1	1	1	
18	210-584-07	Limit Switch	1	1	1	2.5 Kw Heater
18	210-584-08	Limit Switch	1	1	1	3.4 Kw Heater
18	210-584-09	Limit Switch	1	1	1	5.0 Kw Heater
19	606-106-10	Wheel Blower	1	1	1	
20	610-805-38	Capacitor 25/10 MF 370V	1	1		
20	610-805-58	Capacitor 30/10 MF 370V			1	
21	600-840-33	Relay 24V SPST * See Notes	3	3	3	Heat Pump (4)
22	210-568-99	Transformer	1	1	1	
23	800-076-00	Non-Fused Disconnect	1	1	1	
24	250-432-01	Terminal Block	1	1	1	
25	800-103-03	Wrapper Assy. Insulated	1	1		
25	800-103-02	Wrapper Assy. Insulated			1	
N/S	210-586-43	Coil, Solenoid (Rev Valve)	1	1	1	
N/S	250-182-00	Reversing Valve	1			
N/S	250-183-00	Reversing Valve		1		
N/S	250-187-00	Reversing Valve			1	

N/S = Not Shown



FRIEDRICH AIR CONDITIONING CO.

Post Office Box 1540 • San Antonio, Texas 78295-1540
(210) 357-4400 • FAX (210) 357-4480

**VERT- I-PAK® SINGLE PACKAGE
VERTICAL AIR CONDITIONERS
LIMITED WARRANTY**

1. **A) ONE YEAR WARRANTY - FRIEDRICH AIR CONDITIONING CO. (FRIEDRICH)** warrants to the original end-user of this product that should it prove defective due to improper workmanship and/or material under normal use for a period of one year from the date of installation, FRIEDRICH will repair or replace, at its option, any defective part without charge for the part. Replacement parts are warranted for the remainder of the original warranty period.
B) THIS WARRANTY DOES NOT INCLUDE LABOR or other cost incurred for servicing, repairing, removing, installing, shipping, or handling of either defective or replacement parts, or complete unit. Such cost may be covered by a separate warranty provided by the installing contractor.
C) EXTENDED FOUR YEAR COMPRESSOR WARRANTY- During the second through fifth year from the date of installation, should the compressor prove defective due to improper workmanship and/or material, **FRIEDRICH** will furnish a replacement compressor, at no charge, which is warranted for the remainder of the original warranty period. **LABOR IS NOT INCLUDED FOR INSTALLING REPLACEMENT COMPRESSOR.**
D) NOTICE: To obtain service and/or warranty parts replacement, you must notify an authorized FRIEDRICH Air Conditioning Co. distributor, dealer, or contractor of any defect within the applicable warranty period.
2. Any defective part to be replaced must be made available to **FRIEDRICH** in exchange for the replacement part. You must present proof of the original date of installation of the product in order to establish the effective date of the warranty. Otherwise, the effective date will be deemed to be the date of manufacture plus thirty days. The return of the owner registration card is not a condition of warranty coverage. However, please detach and return it so that we can contact you should a question of safety arise which could affect you.
3. **TO OBTAIN WARRANTY SERVICE**, please contact your authorized **FRIEDRICH** distributor, dealer, or the contractor who installed the equipment. If your dealer or contractor needs assistance, the authorized **FRIEDRICH** distributor is available for consultation, and **FRIEDRICH** supports the efforts of the distributor.
4. This limited warranty applies only to units remaining at the site of the original installation (except for mobile home installations) and only to units installed within the continental United States, Alaska, Hawaii, and Canada. This limited warranty applies only if the unit is installed and operated in accordance with FRIEDRICH instructions and in compliance with applicable local installation and building codes and good trade practices.
5. **THIS WARRANTY DOES NOT COVER** damages caused by: (a) accident, abuse, negligence, or misuse; (b) operating the product in a corrosive atmosphere containing chlorine, fluorine or any other damaging chemicals; (c) modification, alteration, poor service practices; (d) improper matching or application of the product or components; (e) failure to provide proper maintenance and service to the product according to manufacture's instructions; (f) installation or operating of the product in a manner contrary to the instructions of the manufacturer; (g) lightning, fluctuations in electrical power or other Acts of God. This **LIMITED WARRANTY** also excludes all cost of installation, disconnection or dismantling the product, parts used in connection with normal maintenance such as air filters or belts and owner-required maintenance. Consult the instructions enclosed with the product for information regarding recommended maintenance.
6. No one is authorized to change this **LIMITED WARRANTY** in any respect, or to create any other obligation or liability in connection with this product.
7. **YOUR ONLY REMEDIES ARE PROVIDED IN THIS LIMITED WARRANTY. ANY EXPRESS WARRANTY NOT PROVIDED HEREIN, AND ANY REMEDY WHICH, BUT FOR THIS PROVISION, MIGHT ARISE BY IMPLICATION OR OPERATION OF LAW, IS HEREBY EXCLUDED AND DISCLAIMED. THE IMPLIED WARRANTIES OF MERCHANTABILITY AND OF FITNESS FOR ANY PARTICULAR PURPOSE ARE EXPRESSLY LIMITED TO A TERM OF ONE YEAR FROM THE DATE OF ORIGINAL INSTALLATION. UNDER NO CIRCUMSTANCES SHALL FRIEDRICH BE LIABLE TO THE OWNER OR ANY OTHER PERSON FOR ANY INCIDENTAL, SPECIAL OR CONSEQUENTIAL DAMAGES IN CONNECTION WITH THIS PRODUCT, WHETHER ARISING OUT OF BREACH OF WARRANTY, BREACH OF CONTRACT OR OTHERWISE.**
8. Some states do not allow limitations on how long an implied warranty lasts and/or do not allow the exclusion or limitation of incidental, special or consequential damages, so the above limitations or exclusions may not apply to you,
9. This warranty gives you specific legal rights, and you may have other rights which vary from state to state and provinces to provinces.

Use Factory Certified Parts.



FRIEDRICH AIR CONDITIONING CO.

Post Office Box 1540 · San Antonio, Texas 78295-1540
4200 N. Pan Am Expressway · San Antonio, Texas 78218-5212
(210) 357-4400 · FAX (210) 357-4480
www.friedrich.com

Printed in the U.S.A.

VPPM03E(8-02)DM