

This Owner's Manual is provided and hosted by [Appliance Factory Parts](#).

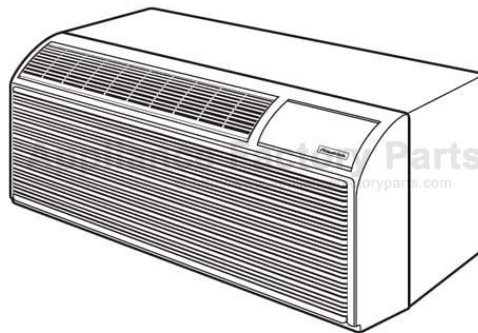

# FRIEDRICH PDE15R3SE-A Owner's Manual

[Shop genuine replacement parts for FRIEDRICH  
PDE15R3SE-A](#)



[Find Your FRIEDRICH Air Conditioner Parts - Select From 1575 Models](#)

----- Manual continues below -----



# F R I E D R I C H

---

## Parts Manual – R410A Models



### **PTAC - PD Series (Electronic Controls)**

Packaged Terminal Air Conditioners

Packaged Terminal Heat Pumps

PTAC PARTS E (1-2010)

# Table of Contents

Unit Identification .....	2
PTAC System Components .....	3
PTAC System Components (Cont'd) .....	4
Control Panel .....	5
Front Cover .....	6
Parts List .....	7-8

# UNIT IDENTIFICATION

Model Number Code

**PD H 07 K 3 S E A**



## PTAC Serial Number Identification Guide

SERIAL NUMBER	A	K	A	M	00001
<b>YEAR MANUFACTURED</b>					<b>PRODUCTION RUN NUMBER</b>
LJ = 2009    AE = 2015					<b>PRODUCT LINE</b> M = PTAC
AK = 2010    AF = 2016					
AA = 2011    AG = 2017					
AB = 2012    AH = 2018					
AC = 2013    AJ = 2019					
AD = 2014					
<b>MONTH MANUFACTURED</b>					
A = Jan	D = Apr	G = Jul	K = Oct		
B = Feb	E = May	H = Aug	L = Nov		
C = Mar	F = Jun	J = Sep	M = Dec		

# PTAC SYSTEM COMPONENTS



# PTAC SYSTEM COMPONENTS (CONT'D)



# PTAC CONTROL PANEL



**Note:** Electronic control kit includes: Electronic control board, dual thermister, single thermister, thermister holder (2), escutcheons (Heat/Cool, Cool Only, Remote Thermostat, 3 total) and installation instructions.

# PTAC FRONT COVER

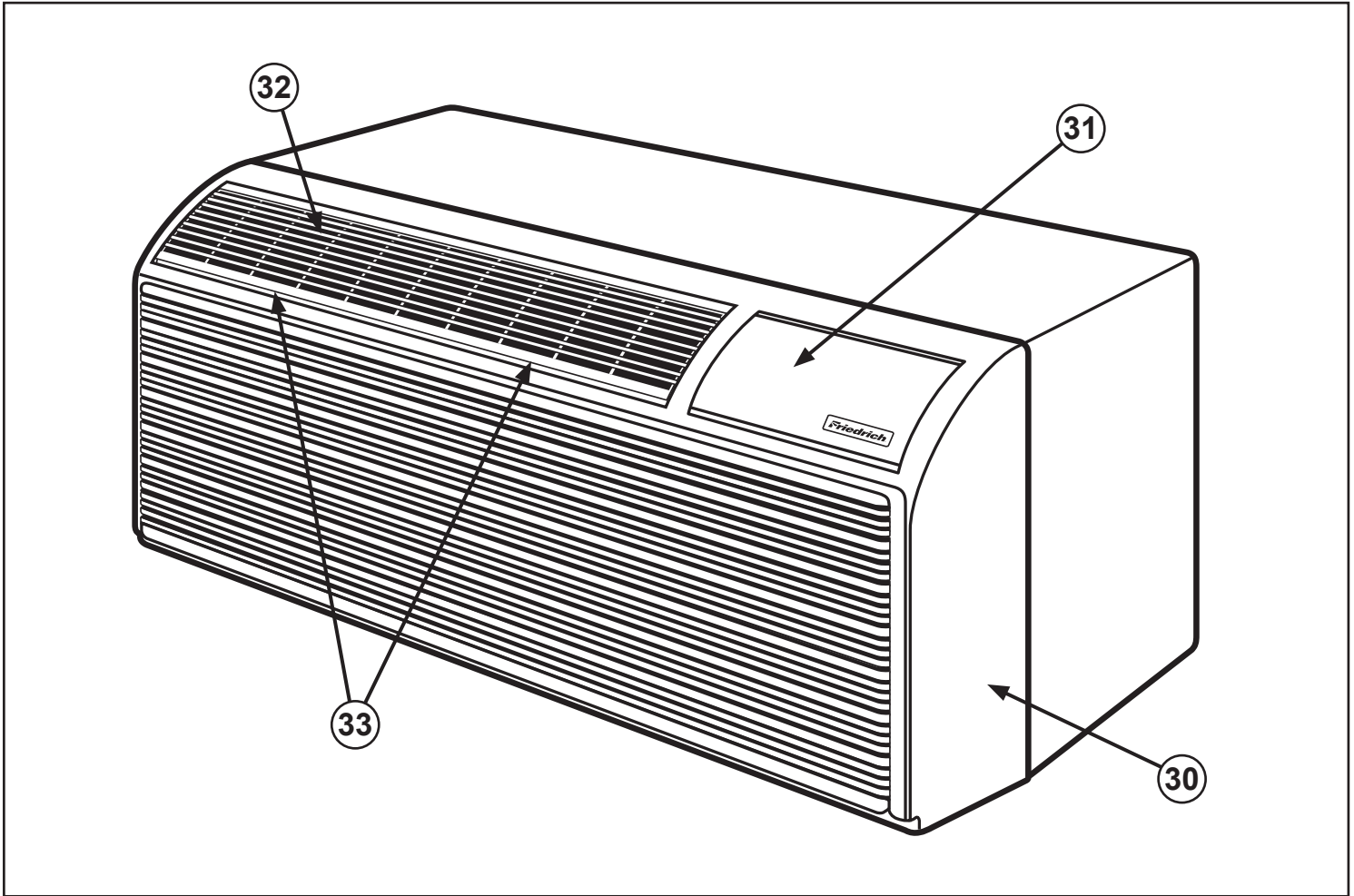





# TECHNICAL SUPPORT CONTACT INFORMATION



**F R I E D R I C H**

**FRIEDRICH AIR CONDITIONING CO.**

Post Office Box 1540 · San Antonio, Texas 78295-1540

4200 N. Pan Am Expressway · San Antonio, Texas 78218-5212

(210) 357-4400 · 1-800-541-6645 · FAX (210) 357-4490

[www.friedrich.com](http://www.friedrich.com)

Printed in the U.S.A.