

This Owner's Manual is provided and hosted by [Appliance Factory Parts](#).

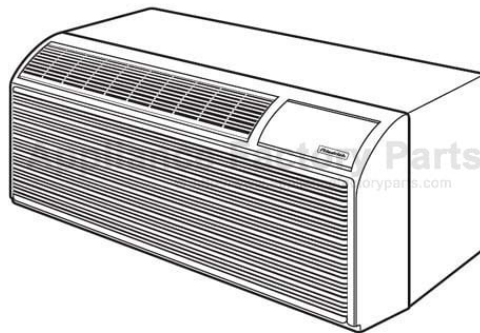

FRIEDRICH PDH09K2SE-A Owner's Manual

[Shop genuine replacement parts for FRIEDRICH
PDH09K2SE-A](#)



[Find Your FRIEDRICH Air Conditioner Parts - Select From 1575 Models](#)

----- Manual continues below -----



F R I E D R I C H

Parts Manual – R410A Models



PTAC - PD Series (Electronic Controls)

Packaged Terminal Air Conditioners

Packaged Terminal Heat Pumps

PTAC PARTS E (1-2010)

Table of Contents

Unit Identification	2
PTAC System Components	3
PTAC System Components (Cont'd)	4
Control Panel	5
Front Cover	6
Parts List	7-8

UNIT IDENTIFICATION

Model Number Code

PD H 07 K 3 S E A



PTAC Serial Number Identification Guide

SERIAL NUMBER	A	K	A	M	00001
YEAR MANUFACTURED					PRODUCTION RUN NUMBER
LJ = 2009 AE = 2015					PRODUCT LINE M = PTAC
AK = 2010 AF = 2016					
AA = 2011 AG = 2017					
AB = 2012 AH = 2018					
AC = 2013 AJ = 2019					
AD = 2014					
MONTH MANUFACTURED					
A = Jan	D = Apr	G = Jul	K = Oct		
B = Feb	E = May	H = Aug	L = Nov		
C = Mar	F = Jun	J = Sep	M = Dec		

PTAC SYSTEM COMPONENTS



PTAC SYSTEM COMPONENTS (CONT'D)



PTAC CONTROL PANEL



Note: Electronic control kit includes: Electronic control board, dual thermister, single thermister, thermister holder (2), escutcheons (Heat/Cool, Cool Only, Remote Thermostat, 3 total) and installation instructions.

PTAC FRONT COVER

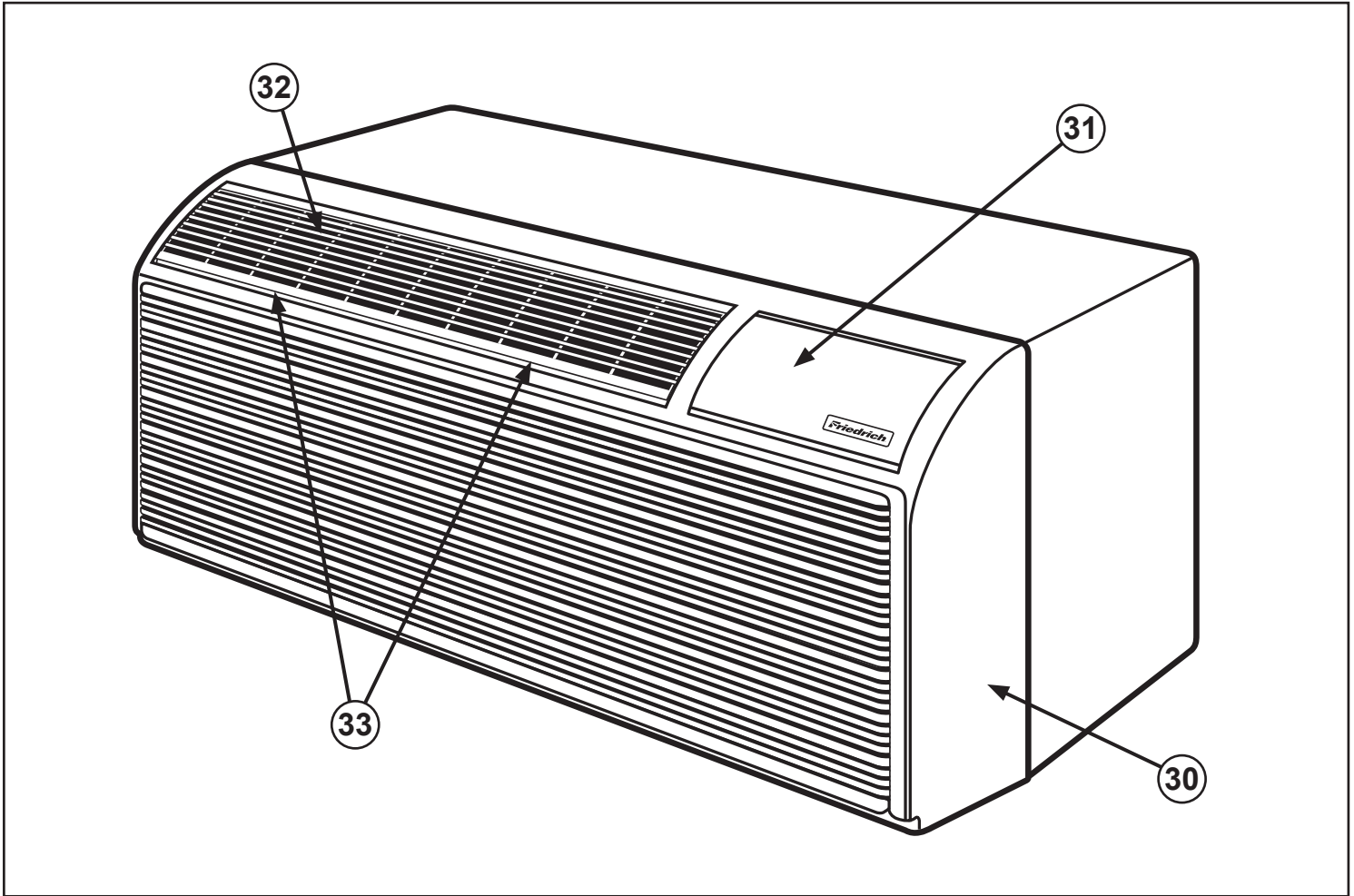

TECHNICAL SUPPORT CONTACT INFORMATION



F R I E D R I C H

FRIEDRICH AIR CONDITIONING CO.

Post Office Box 1540 · San Antonio, Texas 78295-1540

4200 N. Pan Am Expressway · San Antonio, Texas 78218-5212

(210) 357-4400 · 1-800-541-6645 · FAX (210) 357-4490

www.friedrich.com

Printed in the U.S.A.