

This Owner's Manual is provided and hosted by [Appliance Factory Parts](#).

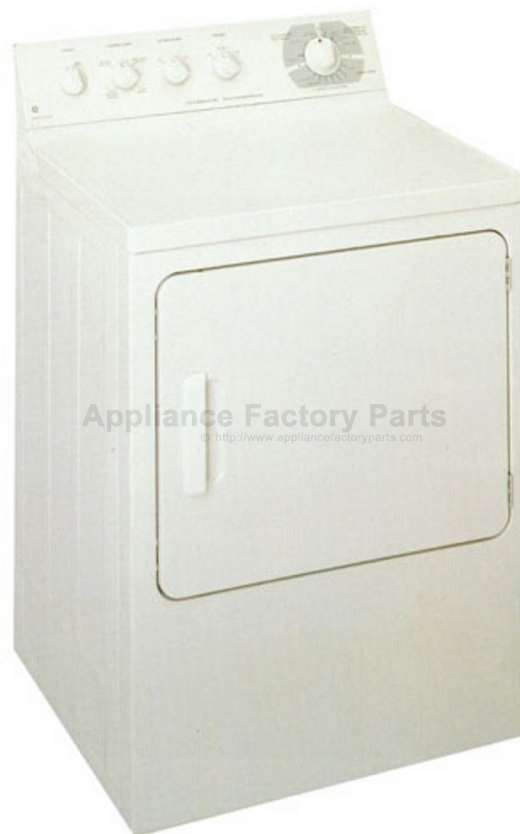

# GE DISR473CG2WW Owner's Manual

[Shop genuine replacement parts for GE  
DISR473CG2WW](#)



[Find Your GE Dryer Parts - Select From 3387 Models](#)

----- Manual continues below -----

---

# Dryers

**Safety Instructions** ..... 2-4

**Operating Instructions**

Control Panel ..... 5

Control Settings ..... 6

Features ..... 7

Loading and Using  
the Dryer ..... 9, 10

Reversing the Door ..... 8

Venting the Dryer ..... 10

**Troubleshooting Tips** ... 11, 12

**Owner's Manual**

DISR333FG

DISR473CG

DISR473DG

# IMPORTANT SAFETY INFORMATION. READ ALL INSTRUCTIONS BEFORE USING.

## ▲ WARNING!

For your safety, the information in this manual must be followed to minimize the risk of fire or explosion, electric shock, or to prevent property damage, personal injury, or death.

- Do not store or use gasoline or other flammable vapors and liquids in the vicinity of this or any other appliance.
- Installation and service must be performed by a qualified installer, service agency or the gas supplier.

## WHAT TO DO IF YOU SMELL GAS:

- 1 Do not try to light a match, or cigarette, or turn on any gas or electrical appliance.
- 2 Do not touch any electrical switch; do not use any phone in your building.
- 3 Clear the room, building or area of all occupants.
- 4 Immediately call your gas supplier from a neighbor's phone. Follow the gas supplier's instructions carefully.
- 5 If you cannot reach your gas supplier, call the fire department.



## PROPER INSTALLATION

This dryer must be properly installed and located in accordance with the Installation Instructions before it is used.

- Properly ground dryer to conform with all governing codes and ordinances. Follow details in Installation Instructions.
- Install or store where it will not be exposed to temperatures below freezing or exposed to the weather, which could cause permanent damage and invalidate the warranty.
- Connect to a properly rated, protected and sized power supply circuit to avoid electrical overload.
- Remove all sharp packing items and dispose of all shipping materials properly.

### Exhaust/Ducting:

- 1 Gas dryers **MUST** be exhausted to the outside.
- 2 Use only rigid metal 4" diameter ductwork inside the dryer cabinet. Use only rigid metal or flexible metal 4" diameter ductwork for exhausting to the outside. **USE OF PLASTIC OR OTHER COMBUSTIBLE DUCTWORK CAN CAUSE A FIRE. PUNCTURED DUCTWORK CAN CAUSE A FIRE IF IT COLLAPSES OR BECOMES OTHERWISE RESTRICTED IN USE OR DURING INSTALLATION.**

For complete details, follow the Installation Instructions.

## ⚠ WARNING!



### YOUR LAUNDRY AREA

- Keep the area underneath and around your appliances free of combustible materials (lint, paper, rags, etc.), gasoline, chemicals and other flammable vapors and liquids.
- Keep the floor around your appliances clean and dry to reduce the possibility of slipping.
- Close supervision is necessary if this appliance is used by or near children. Do not allow children to play on, with or inside this or any other appliance.
- Keep all laundry aids (such as detergents, bleaches, etc.) out of the reach of children, preferably in a locked cabinet. Observe all warnings on container labels to avoid injury.
- Never climb on or stand on the dryer top.



### WHEN USING YOUR DRYER

- Never reach into the dryer while the drum is moving. Before loading, unloading or adding clothes, wait until the drum has completely stopped.
- Clean the lint filter before each load to prevent lint accumulation inside the dryer or in the room. **DO NOT OPERATE THE DRYER WITHOUT THE LINT FILTER IN PLACE.**
- Do not wash or dry articles that have been cleaned in, washed in, soaked in or spotted with combustible or explosive substances (such as wax, oil, paint, gasoline, degreasers, dry-cleaning solvents, kerosene, etc.). These substances give off vapors that may ignite or explode. Do not add these substances to the wash water. Do not use or place these substances around your washer or dryer during operation.
- Do not place items exposed to cooking oils in your dryer. Items contaminated with cooking oils may contribute to a chemical reaction that could cause a clothes load to catch fire.
- Any article on which you have used a cleaning solvent or that contains flammable materials (such as cleaning cloths, mops, towels used in beauty salons, restaurants, or barber shops, etc.) must not be placed in or near the dryer until solvents or flammable materials have been removed. There are many highly flammable items used in homes such as acetone, denatured alcohol, gasoline, kerosene, some household cleaners, some spot removers, turpentine, waxes, wax removers and products containing petroleum distillates.
- The laundry process can reduce the flame retardancy of fabrics. To avoid such a result, carefully follow the garment manufacturer's care instructions.
- Do not dry articles containing rubber, plastic or similar materials such as padded bras, tennis shoes, galoshes, bath mats, rugs, bibs, baby pants, plastic bags, pillows, etc. that may melt or burn. Some rubber materials, when heated, can under certain circumstances produce fire by spontaneous combustion.
- Do not store plastic, paper or clothing that may burn or melt on top of the dryer during operation.
- Garments labeled *Dry Away from Heat* or *Do Not Tumble Dry* (such as life jackets containing Kapok) must not be put in your dryer.
- Do not dry fiberglass articles in your dryer. Skin irritation could result from the remaining particles that may be picked up by clothing during subsequent dryer uses.
- To minimize the possibility of electric shock, unplug this appliance from the power supply or disconnect the dryer at the household distribution panel by removing the fuse or switching off the circuit breaker before attempting any maintenance or cleaning (except the removal and cleaning of the lint filter). **NOTE:** Turning the Cycle Selector knob to an off position or pressing PAUSE does **NOT** disconnect the appliance from the power supply.

# IMPORTANT SAFETY INFORMATION. READ ALL INSTRUCTIONS BEFORE USING.

## ⚠ WARNING!



### WHEN USING YOUR DRYER (cont.)

- Never attempt to operate this appliance if it is damaged, malfunctioning, partially disassembled, or has missing or broken parts, including a damaged cord or plug.
- The interior of the machine and the exhaust duct connection inside the dryer should be cleaned at least once a year by a qualified technician. See the *Loading and Using the Dryer* section.
- If yours is a gas dryer, it is equipped with an automatic electric ignition and does not have a pilot light. **DO NOT ATTEMPT TO LIGHT WITH A MATCH.** Burns may result from having your hand in the vicinity of the burner when the automatic ignition turns on.
- You may wish to soften your laundered fabrics or reduce the static electricity in them by using a dryer-applied fabric softener or an anti-static conditioner. We recommend you use either a fabric softener in the wash cycle, according to the manufacturer's instructions for those products, or try a dryer-added product for which the manufacturer gives written assurance on the package that their product can be safely used in your dryer. Service or performance problems caused by use of these products are the responsibility of the manufacturers of those products and are not covered under the warranty to this appliance.



### WHEN NOT USING YOUR DRYER

- Grasp the plug firmly when disconnecting this appliance to avoid damage to the cord while pulling. Place the cord away from traffic areas so it will not be stepped on, tripped over or subjected to damage.
- Do not attempt to repair or replace any part of this appliance or attempt any servicing unless specifically recommended in this Owner's Manual or in published user-repair instructions that you understand and have the skills to carry out.
- Before discarding a dryer, or removing it from service, remove the dryer door to prevent children from hiding inside.
- Do not tamper with controls.



**READ AND FOLLOW THIS SAFETY INFORMATION CAREFULLY.  
SAVE THESE INSTRUCTIONS**

# About the dryer control panel.

You can locate your model number on the label on the front of the dryer behind the door. Throughout this manual, features and appearance may vary from your model.

## Model DISR333



## Models DISR473C and DISR473D

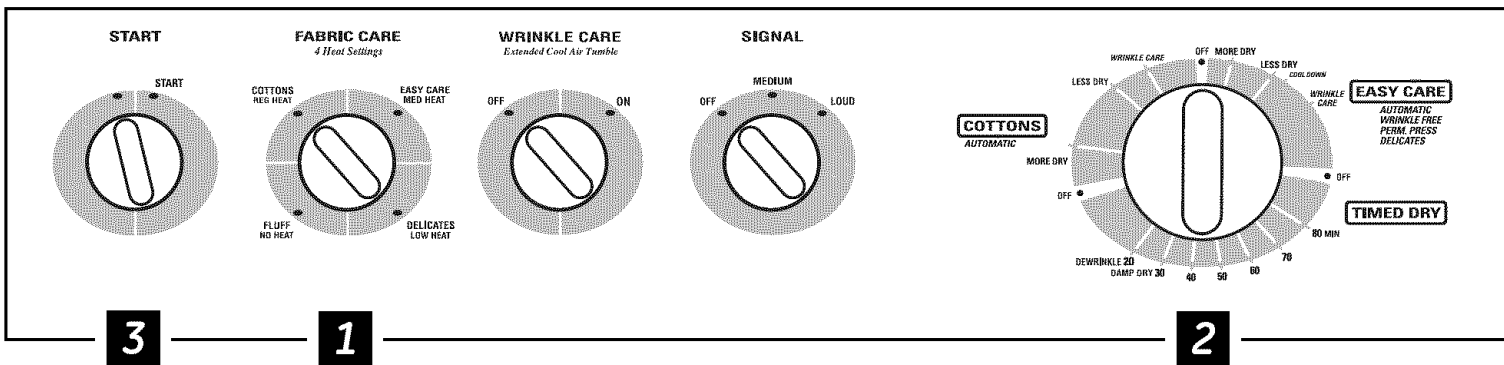

**NOTE:** Drying times will vary according to the type of heat used (Electric, Natural or LP gas), size of load, types of fabrics, wetness of clothes and condition of exhaust ducts.

## About the control settings.

**IMPORTANT:** Clean the lint filter each time you use the dryer.

### 1 Fabric Care/Temperature (on some models)

**COTTONS HIGH/REG. HEAT** For regular to heavy cottons.

**PERMA PRESS/EASY CARE MEDIUM** For synthetics, blends, delicates and items labeled *permanent press*.

**DELICATES LOW** On some models. For delicates, synthetics and items labeled *tumble dry low*.

**FLUFF NO HEAT** For fluffing items without heat. Use the **TIMED DRY** cycle.

Automatic cycles automatically determine fabric dryness. Select **LESS DRY** if you want your clothes slightly damp at the end of the drying cycle. Select **MORE DRY** if you want them to feel drier. Timed cycles run for a selected time.

### 2 Drying Cycles

**COTTONS** For cottons and most linens. For most loads select **OPTIMUM DRY** (on some models) or select the Preferred Regular Setting marked with an \*.

**PERMANENT PRESS/EASY CARE** For wrinkle-free, permanent press and delicate items, and knits.

**TIMED DRY** Set the Cycle Selector at the desired drying time.

**DAMP DRY** For leaving items partially damp.

**DEWRINKLE** For removing wrinkles from items that are clean and dry or that are very lightly damp.

**FLUFF or QUICK FLUFF FLUFF NO HEAT.** For freshening or fluffing up already dry clothing, fabrics, linens and pillows. Use with **FLUFF NO HEAT**. Provides 10 minutes of no heat tumbling.

### 3 Start – Close the dryer door. Select **START**. Opening the door during operation will stop the dryer. To restart the dryer, close the door and select **START** to complete the cycle.

## About the dryer features.

### WRINKLE CARE Extended Cool Air Tumble

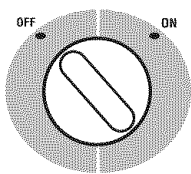

### Wrinkle Care Option (on some models)

Use this option to minimize the wrinkles in clothes. It provides approximately 15 minutes of no-heat tumbling after the clothes are dry.

This option can only be used with the **COTTONS** and **EASY CARE** cycles.

If you are using the **SIGNAL** knob and you select the **WRINKLE CARE** option, a signal will sound at the end of the drying time and several times during the **WRINKLE CARE** cycle. This will remind you that it is time to remove the clothes.

If **WRINKLE CARE** is not on, the dryer will stop once the timer reaches the **WRINKLE CARE** mark on the cycle dial.

### SIGNAL

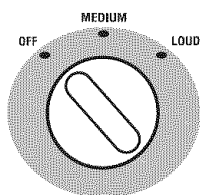

### Cycle Signal Option (on some models)

This signal will sound just before the end of the cycle to remind you to remove the clothes. On some models, the signal sound level cannot be adjusted.

If you selected the **WRINKLE CARE** option, the signal will sound at the end of the drying time and will sound several times during the **WRINKLE CARE** cycle. This will remind you that it is time to remove the clothes.

### NOTE:

- **Remove garments promptly at the sound of the signal. Place clothes on hangers so wrinkles won't set in.**
- **Use the Cycle Signal especially when drying fabrics like polyester knits and permanent press. These fabrics should be removed so wrinkles won't set in.**

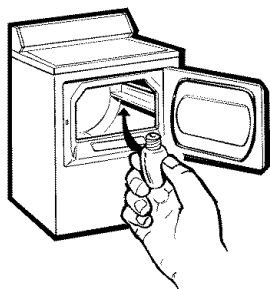

### Drum Lamp (on some models)

Before replacing the light bulb, be sure to unplug the dryer power cord or disconnect the dryer at the household distribution panel by removing the fuse or switching off the circuit breaker. Reach above dryer opening from inside the drum. Remove the bulb and replace with the same size bulb.

## About reversing the door.

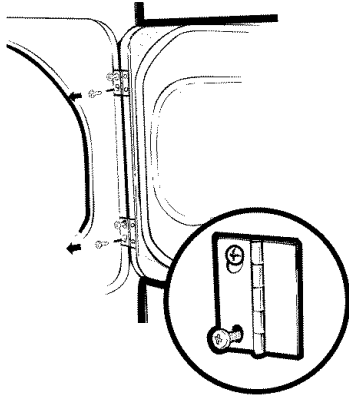

### Reversing the Door

Tools needed:

- Standard #2 Phillips screwdriver
- Tape-tipped putty knife

- 1 Open the door and remove the filler plugs opposite the hinges. With the door completely open, remove the bottom screw from each hinge on the dryer face. Insert these screws about half way into the **TOP** holes, for each hinge, on the opposite side (where you removed the filler plugs). Apply firm pressure to get the screw started in new holes.
- 2 Loosen top screw from each hinge on the dryer face half way. With one hand holding the top of the door and the other hand holding the bottom, remove the door from the dryer by lifting it **UP** and **OUT**.
- 3 Rotate the door 180°. Insert it on the opposite side of the opening by moving the door **IN** and **DOWN** until the top hinge and the bottom hinge are resting on the top screws inserted in step 1.
- 4 Remove the remaining screws from the side of the opening from which the door was removed. With these screws, secure each hinge at the bottom. Tighten the 2 top screws of each hinge. Reinsert the plastic plugs on the side from which the door was removed.

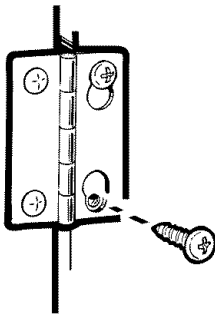
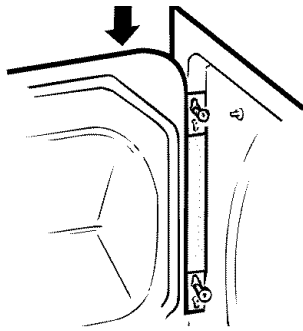
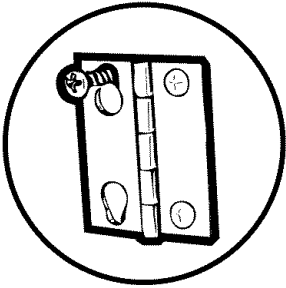

# Loading and using the dryer.

Always follow the fabric manufacturer's care label when laundering.



## Sorting and Loading Hints

As a general rule, if clothes are sorted properly for the washer, they are sorted properly for the dryer.

Do not add fabric softener sheets once the load has become warm. They may cause fabric softener stains. Bounce® Fabric Conditioner Dryer Sheets have been approved for use in all GE Dryers when used in accordance with the manufacturer's instructions.

**Do not overload.** This wastes energy and causes wrinkling.

**Do not dry the following items:** fiberglass items, woolens, rubber-coated items, plastics, items with plastic trim and foam-filled items.



## Care and Cleaning of the Dryer

**The Exterior:** Wipe or dust any spills or washing compounds with a damp cloth. Dryer control panel and finishes may be damaged by some laundry pretreatment soil and stain remover products. Apply these products away from the dryer. The fabric may then be washed and dried normally. Damage to your dryer caused by these products is not covered by your warranty.

**The Lint Filter:** Clean the lint filter before each use. Moisten your fingers and reach into the filter opening. Run your fingers across the filter. Have a qualified technician vacuum the lint from the dryer once a year.

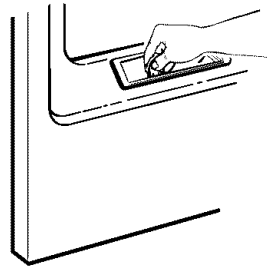

**The Exhaust Duct:** Inspect and clean the exhaust ducting at least once a year to prevent clogging. A partially clogged exhaust can lengthen the drying time.

Follow these steps:

- 1 Turn off electrical supply by disconnecting the plug from the wall socket.
- 2 Disconnect the duct from the dryer.
- 3 Vacuum the duct with the hose attachment and reconnect the duct.

**The Exhaust Hood:** Check from the outside that the flaps of the hood move freely when operating. Make sure that there is no wildlife (birds, insects, etc.) nesting inside the duct or hood.

**Loading and using the dryer.** Always follow the fabric manufacturer's care label when laundering.



## Venting the Dryer

For the best drying performance, the dryer needs to be properly vented. **The dryer will use more energy and run longer if it is not vented to the below specifications. Carefully follow the details on Exhausting in the Installation Instructions.**

- Use only rigid metal 4" diameter ductwork inside the dryer cabinet. Use only rigid metal or flexible metal 4" diameter ductwork for exhausting to the outside.
- Do not use plastic or other combustible ductwork.
- Use the shortest length possible.
- Do not crush or collapse.
- Avoid resting the duct on sharp objects.
- **Venting must conform to local building codes.**

Correct Venting

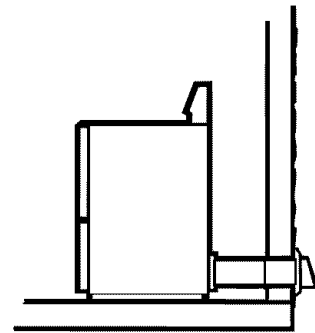
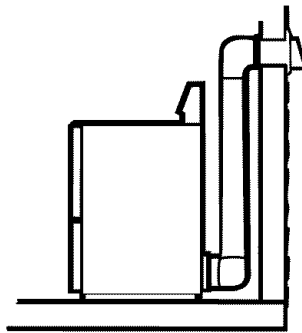

Incorrect Venting

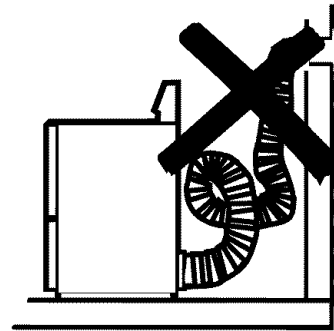
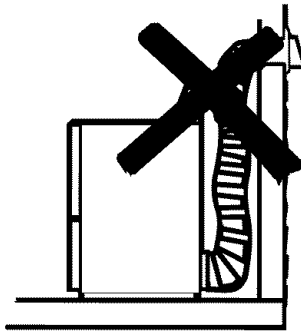

## Before you call for service...



**Troubleshooting Tips**  
Save time and money! Review the charts on the following pages.  
You may not need to call for service.

Problem	Possible Causes	What To Do
Dryer doesn't start	Dryer is unplugged	<ul style="list-style-type: none"> <li>Make sure the dryer plug is pushed completely into the outlet.</li> </ul>
	Fuse is blown/circuit breaker is tripped	<ul style="list-style-type: none"> <li>Check the house fuse/circuit breaker box and replace fuse or reset breaker. <b>NOTE:</b> Electric dryers use two fuses or breakers.</li> </ul>
Dryer doesn't heat	Fuse is blown/circuit breaker is tripped, the dryer may tumble but not heat	<ul style="list-style-type: none"> <li>Check the house fuse/circuit breaker box and replace both fuses or reset both breakers. Your dryer may tumble if only one fuse is blown or one breaker tripped.</li> </ul>
	Gas service is off	<ul style="list-style-type: none"> <li>Make sure gas shutoff at dryer and main shutoff are fully open.</li> </ul>
	LP gas supply tank is empty or there has been a utility interruption of natural gas (gas models)	<ul style="list-style-type: none"> <li>Refill or replace tank. Dryer should heat when utility service is restored.</li> </ul>
Dryer shakes or makes noise	Some shaking/noise is normal. Dryer may be sitting unevenly	<ul style="list-style-type: none"> <li>Move dryer to an even floor space, or adjust leveling legs as necessary until even.</li> </ul>
Greasy spots on clothes	Improper use of fabric softener	<ul style="list-style-type: none"> <li>Follow directions on fabric softener package.</li> </ul>
	Drying dirty items with clean ones	<ul style="list-style-type: none"> <li>Use your dryer to dry only clean items. Dirty items can stain clean items and the dryer.</li> </ul>
	Clothes were not completely clean	<ul style="list-style-type: none"> <li>Sometimes stains which cannot be seen when the clothes are wet <i>appear</i> after drying. Use proper washing procedures before drying.</li> </ul>
Lint on clothes	Lint filter is full	<ul style="list-style-type: none"> <li>Clean lint screen before each load.</li> </ul>
	Improper sorting	<ul style="list-style-type: none"> <li>Sort lint producers (like chenille) from lint collectors (like corduroy).</li> </ul>
	Static electricity can attract lint	<ul style="list-style-type: none"> <li>See suggestions in this section under <b>STATIC</b>.</li> </ul>
	Overloading	<ul style="list-style-type: none"> <li>Separate large loads into smaller ones.</li> </ul>
	Paper, tissue, etc. left in pockets	<ul style="list-style-type: none"> <li>Empty all pockets before laundering clothes.</li> </ul>
Static occurs	No fabric softener was used	<ul style="list-style-type: none"> <li>Try a fabric softener.</li> <li>Bounce® Fabric Conditioner Dryer Sheets have been approved for use in all GE Dryers when used in accordance with the manufacturer's instructions.</li> </ul>
	Overdrying	<ul style="list-style-type: none"> <li>Try a fabric softener.</li> <li>Adjust setting to <b>LESS DRY</b> or <b>DAMP DRY</b>.</li> </ul>
	Synthetics, permanent press and blends can cause static	<ul style="list-style-type: none"> <li>Try a fabric softener.</li> </ul>
Inconsistent drying times	Type of heat	<ul style="list-style-type: none"> <li>Automatic drying times will vary according to the type of heat used (electric, natural or LP gas), size of load, types of fabrics, wetness of clothes and condition of exhaust ducts.</li> </ul>

# Before you call for service...



## Troubleshooting Tips

### Safety Instructions

### Operating Instructions

<i>Problem</i>	<i>Possible Causes</i>	<i>What To Do</i>
<i>Clothes take too long to dry</i>	<b>Improper sorting</b>	<ul style="list-style-type: none"> <li>Separate heavy items from lightweight items (generally, a well-sorted washer load is a well-sorted dryer load).</li> </ul>
	<b>Large loads of heavy fabrics (like beach towels)</b>	<ul style="list-style-type: none"> <li>Large, heavy fabrics contain more moisture and take longer to dry. Separate large, heavy fabrics into smaller loads to speed drying time.</li> </ul>
	<b>Controls improperly set</b>	<ul style="list-style-type: none"> <li>Match control settings to the load you are drying.</li> </ul>
	<b>Lint filter is full</b>	<ul style="list-style-type: none"> <li>Clean lint filter before every load.</li> </ul>
	<b>Improper or obstructed ducting</b>	<ul style="list-style-type: none"> <li>Check installation instructions for proper ducting/venting.</li> <li>Make sure ducting is clean, free of kinks and unobstructed.</li> <li>Check to see if outside wall damper operates easily.</li> <li>Check the Installation Instructions to make sure the dryer venting is correct.</li> </ul>
	<b>Blown fuses or tripped circuit breaker</b>	<ul style="list-style-type: none"> <li>Replace fuses or reset circuit breakers. Since most dryers use two fuses/breakers, make sure both are operating.</li> </ul>
<i>Clothes are wrinkled</i>	<b>Overloading/combining loads</b>	<ul style="list-style-type: none"> <li>Do not put more than one washer load in the dryer at a time.</li> </ul>
	<b>Underloading</b>	<ul style="list-style-type: none"> <li>If you are drying only one or two items, add a few items to ensure proper tumbling.</li> </ul>
	<b>Overdrying</b>	<ul style="list-style-type: none"> <li>Select a shorter drying time.</li> <li>Remove items while they still hold a slight amount of moisture. Select a <b>LESS DRY</b> or <b>DAMP DRY</b> setting.</li> </ul>
	<b>Letting items sit in dryer after cycle ends</b>	<ul style="list-style-type: none"> <li>Remove items when cycle ends and fold or hang immediately.</li> </ul>
<i>Clothes shrink</i>	<b>Overloading</b>	<ul style="list-style-type: none"> <li>Separate large loads into smaller ones.</li> </ul>
	<b>Some fabrics will naturally shrink when washed. Others can be safely washed, but will shrink in the dryer</b>	<ul style="list-style-type: none"> <li>To avoid shrinkage, follow garment care labels exactly.</li> <li>Some items may be pressed back into shape after drying.</li> <li>If you are concerned about shrinkage in a particular item, do not machine wash or tumble dry it.</li> </ul>

### Troubleshooting Tips