

This Owner's Manual is provided and hosted by [Appliance Factory Parts](#).

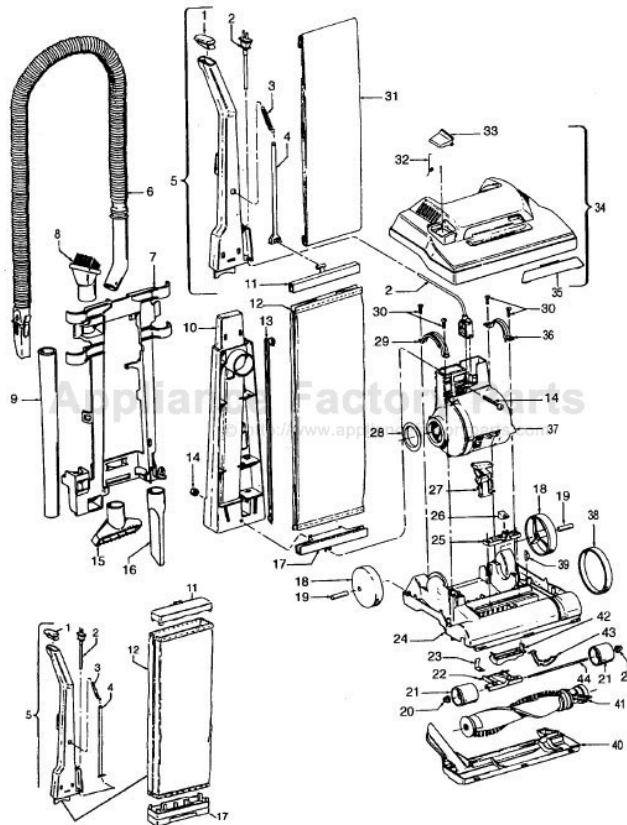

# HOOVER U4253-930 Owner's Manual

[Shop genuine replacement parts for HOOVER  
U4253-930](#)



[Find Your HOOVER Vacuum Cleaner Parts - Select From 1456 Models](#)

----- Manual continues below part list -----

## Available Replacement Parts for HOOVER U4253-930

<a href="#">H-38528040</a>	BELT VACUUM HOOVER OEM (1 PACK)
<a href="#">48414036</a>	HOOVER ELITE BRUSH ROLLER
<a href="#">H-4010001A</a>	VACUUM BAG OEM HOOVER 3 PACK
<a href="#">H-43267002</a>	AGITATOR BEARING ASM
<a href="#">K-109289</a>	BULB

Elite II

Model U4253-930, U4258-930, U4260-930, U4270-930  
U4270-940

Sprint

Model U4257-930, U4262-930

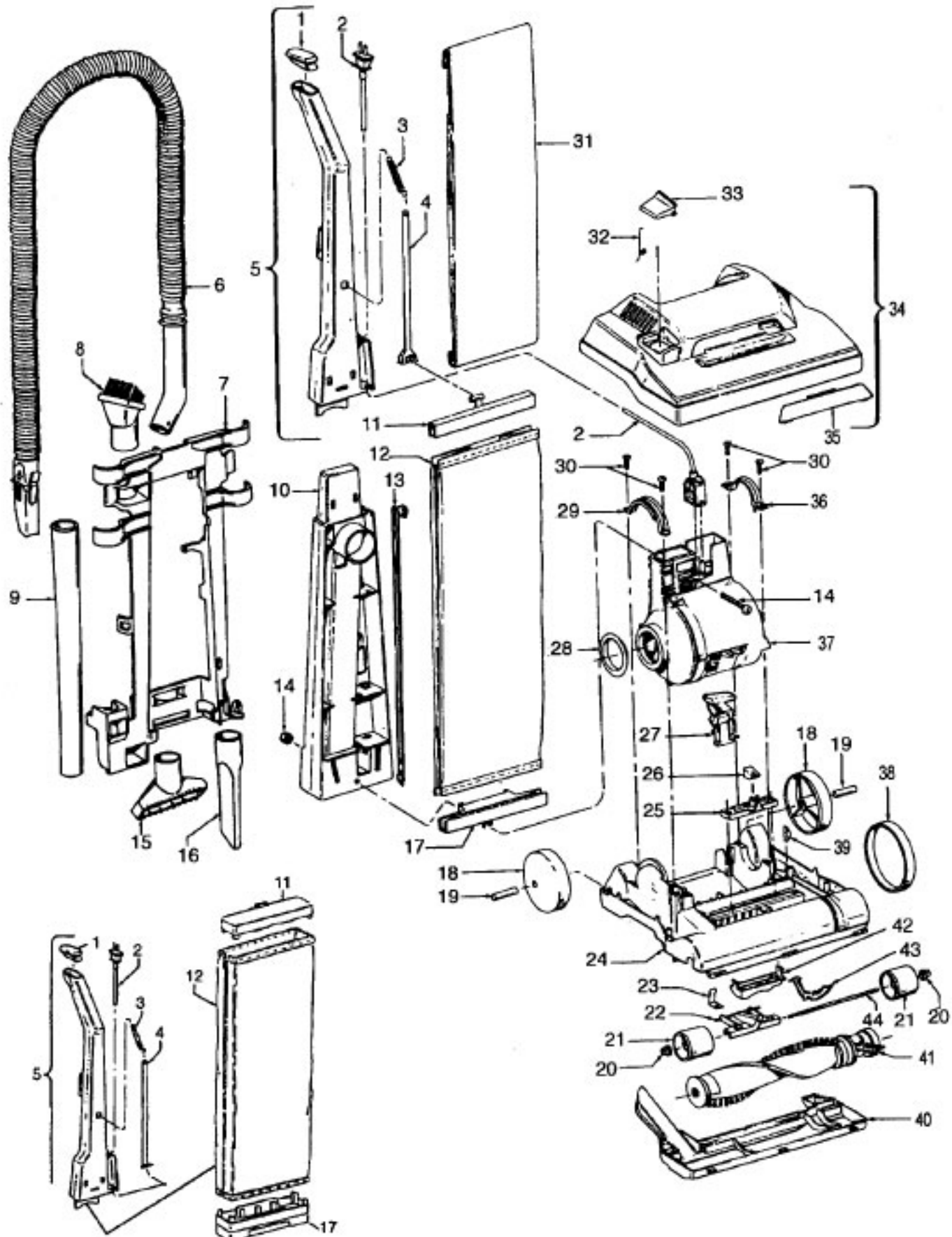

Used on Models : U4270-930, U4270-940



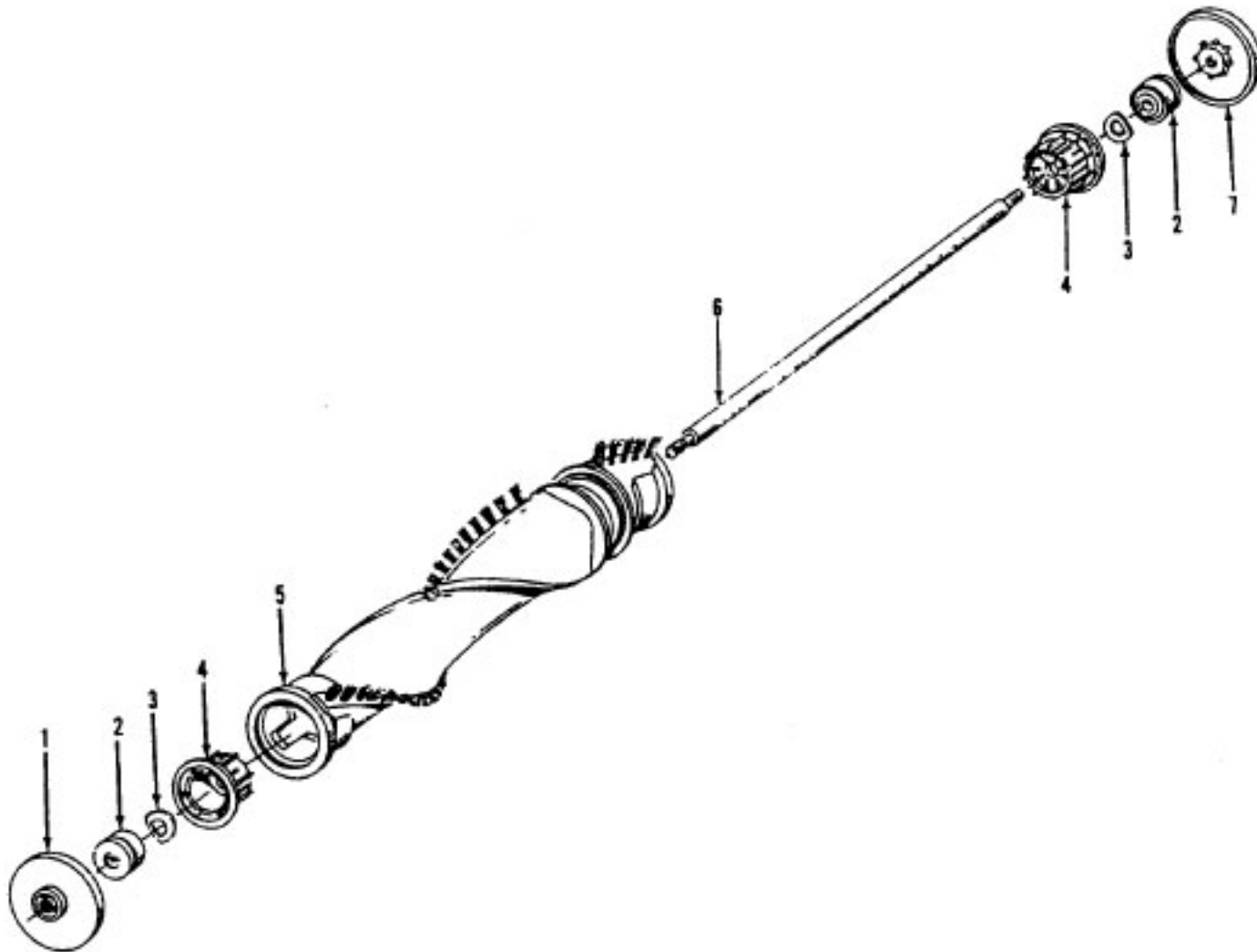

Ref. No.	Part No.	Description
	48414079	Agitator Assem. Comp. - AG
1	36423016	Thread Guard - RH
2	43267002	Agitator Bearing Assem. (2)
3	21347003	Conical Washer (2)
4	36422022	Agitator End (2)
5	N/A	Agitator Body
6	32724013	Agitator Shaft
7	36423017	Thread Guard - LH - AG

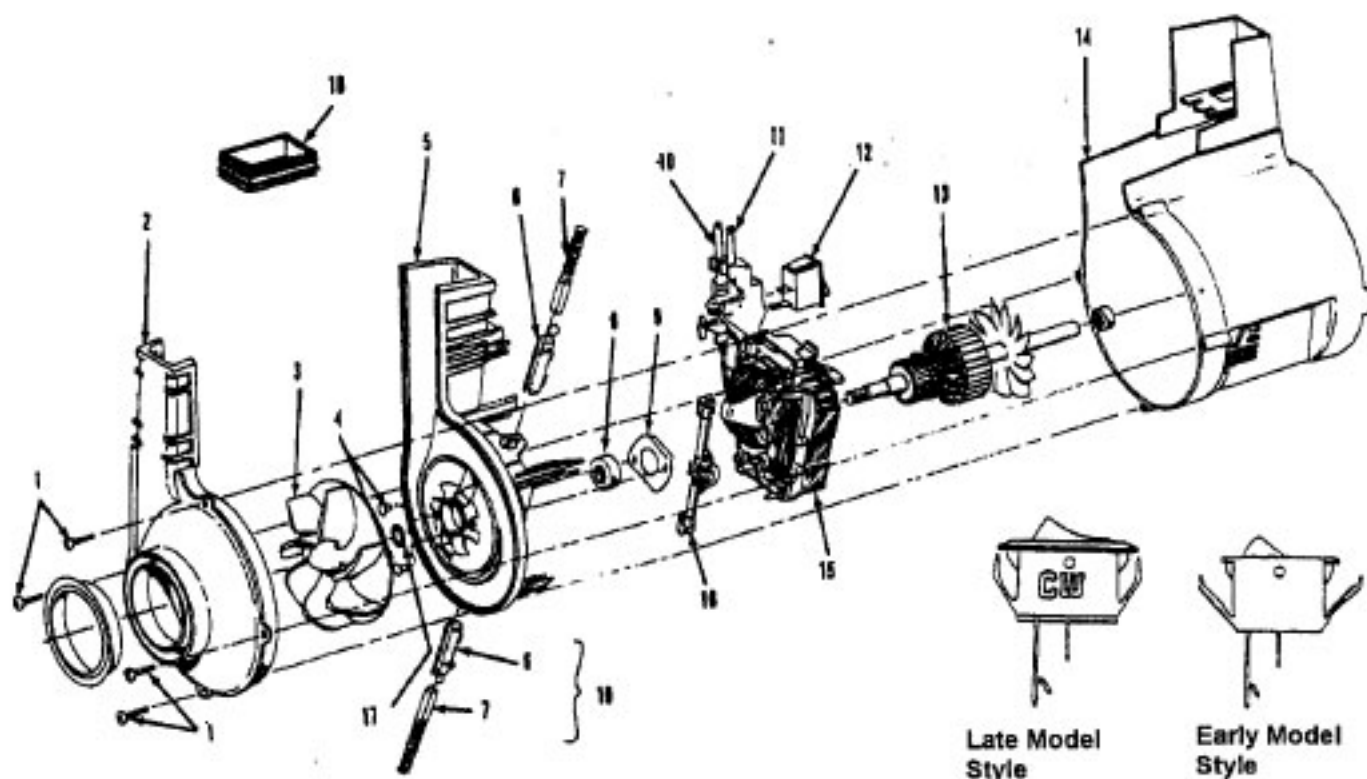

Ref. No.	Part No.	Description
	43576142	Motor Assem. Comp.
	43576181	Motor Assem. Comp. (Replaced by 43576204)
1	214793DA	Screw-Self Tapping (4)
2	38736033	Fan Chamber
3	38755030	Fan
4	N/A	Rivet - Semi Tubular (2)
5	N/A	Motor Housing Assem.
6	N/A	Motor Brush Holder (2)
7	N/A	Motor Brush Assem. (2)
8	N/A	Bearing
9	N/A	Bearing Retainer
10	36914004	Switch Bus Bar
11	39116005	Attachment Terminal
12	28218043	Switch Assem. - Early Models (Prior to 5/96)
	28161062	Switch Assem. - Late Models (After 5/96)
13	N/A	Armature/Bearing Assem.
14	37194046	Motor End Cap Assem. - MW
15	N/A	Field Assem.
16	N/A	Lamp Holder Assem.
17	21312793	Washer
18	38783020	Duct Seal
19	41311016	Motor Brush Holder Assem.

ITEMS NOT ILLUSTRATED

38781013	Duct Seal (8 1/2" Long adhesive backed foam seal used on early models in place of item 18)
54821001	Tape (Roll)