

This Owner's Manual is provided and hosted by [Appliance Factory Parts](#).

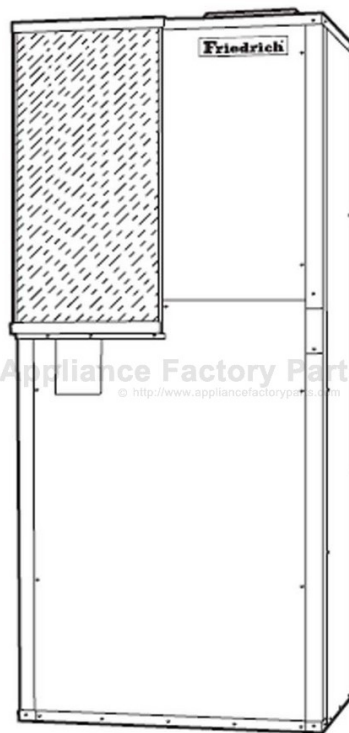

FRIEDRICH VEB49KXX Owner's Manual

[Shop genuine replacement parts for FRIEDRICH
VEB49KXX](#)



[Find Your FRIEDRICH Refrigerator Parts - Select From 20 Models](#)

----- Manual continues below -----



Parts Manual

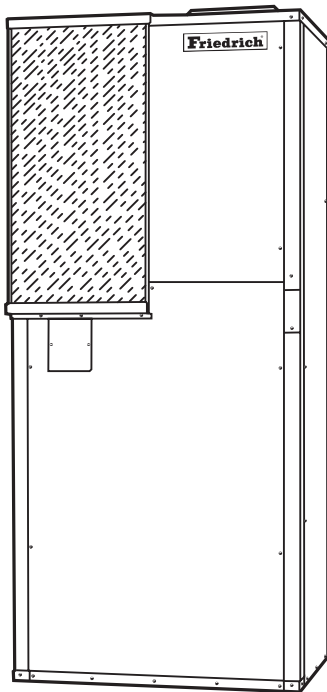

Vert-I-Pak B-Series

Table of Contents

Model Identification Guide	3
Serial Number Identification Guide.....	3
Typical Control Box Assembly	4
Typical Blower Assembly	5
Typical Refrigeration / Condenser Fan - VEB Heat/Cool Models	6
Parts List - VEB Heat / Cool Models	7-9
Typical Refrigeration / Condenser Fan - VHB Heat Pump Models.....	10
Parts List - VHB Heat Pump Models	11-13

Model Identification Guide

MODEL NUMBER	V	E	A	24	K	50	RT	B
SERIES V=Vertical Series								ENGINEERING CODE
E=Cooling with or without electric heat H=Heat Pump								OPTIONS RT = Standard Remote Operation SP = Seacoast Protected
DESIGN SERIES A = 32" and 47" Cabinet B = 68" Cabinet								ELECTRIC HEATER SIZE B Series 00 = No electric heat 05 = 5.0 KW 10 = 10.0 KW 15 = 15.0 KW 20 = 20.0 KW 25 = 25.0 KW
NOMINAL CAPACITY B Series (Btu/h) 18 = 18,000 42 = 42,000 24 = 24,000 49 = 49,000 30 = 30,000 60 = 60,000 36 = 36,000								
VOLTAGE K = 208/230V-1Ph-60Hz								

Serial Number Identification Guide

SERIAL NUMBER Decade Manufactured J = 9 K = Not Used L = 0	L	K	A	V	00001	
YEAR MANUFACTURED A = 1 E = 5 J = 9 B = 2 F = 6 K = 0 C = 3 G = 7 D = 4 H = 8						PRODUCTION RUN NUMBER
MONTH MANUFACTURED A = Jan D = Apr G = Jul K = Oct B = Feb E = May H = Aug L = Nov C = Mar F = Jun J = Sep M = Dec						PRODUCT LINE R = RAC P = PTAC E = EAC V = VPAK H = SPLIT

This document reflected an accurate listing of parts and information at the time of its publication. Our policy of continuously upgrading and improving our products makes it impossible to keep it up to date. Your Friedrich dealer, his supplier and the Customer Service Department at Friedrich will have the latest information should problems arise. Please contact us.

Typical Control Box

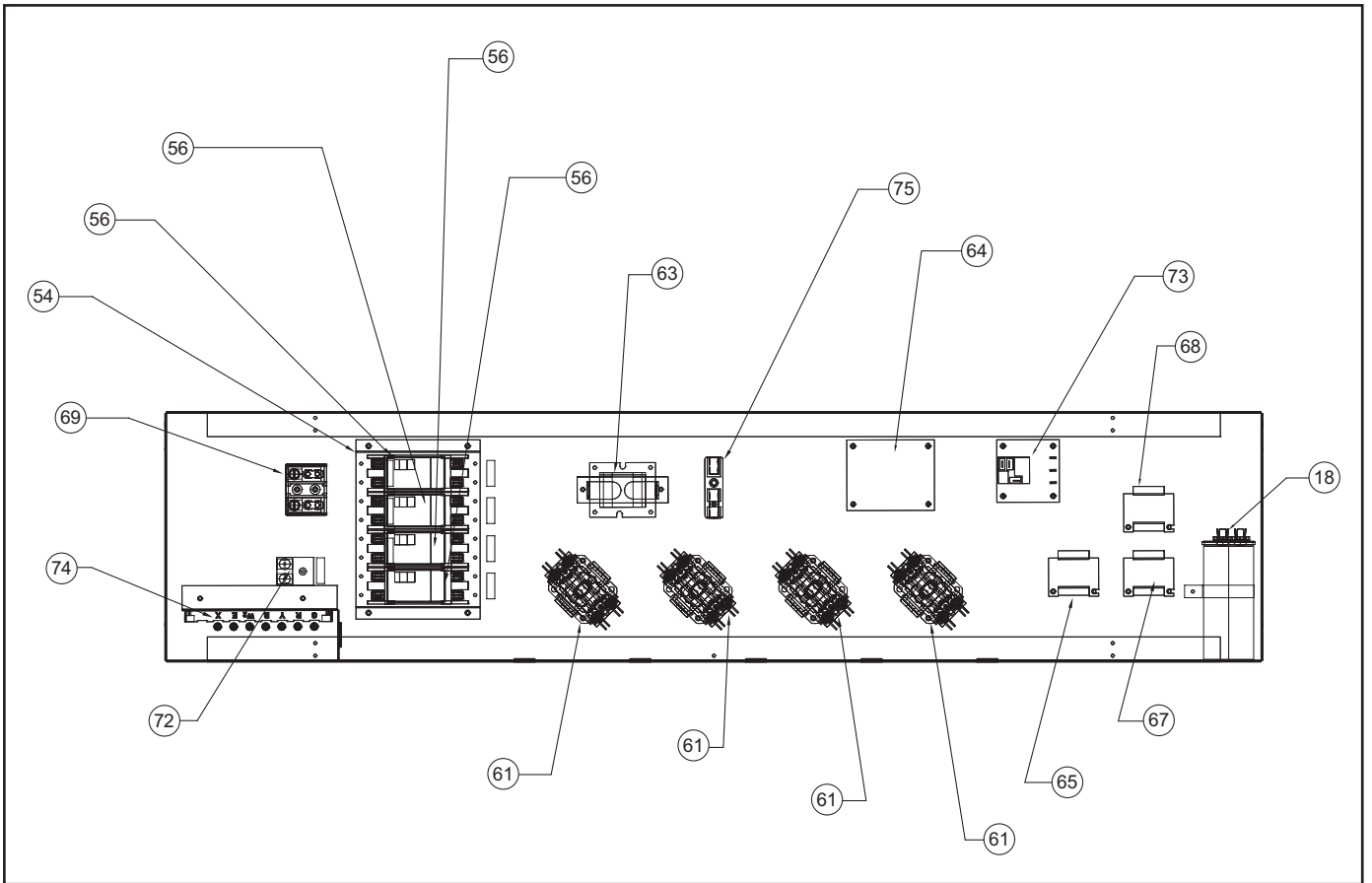

Typical Indoor Blower

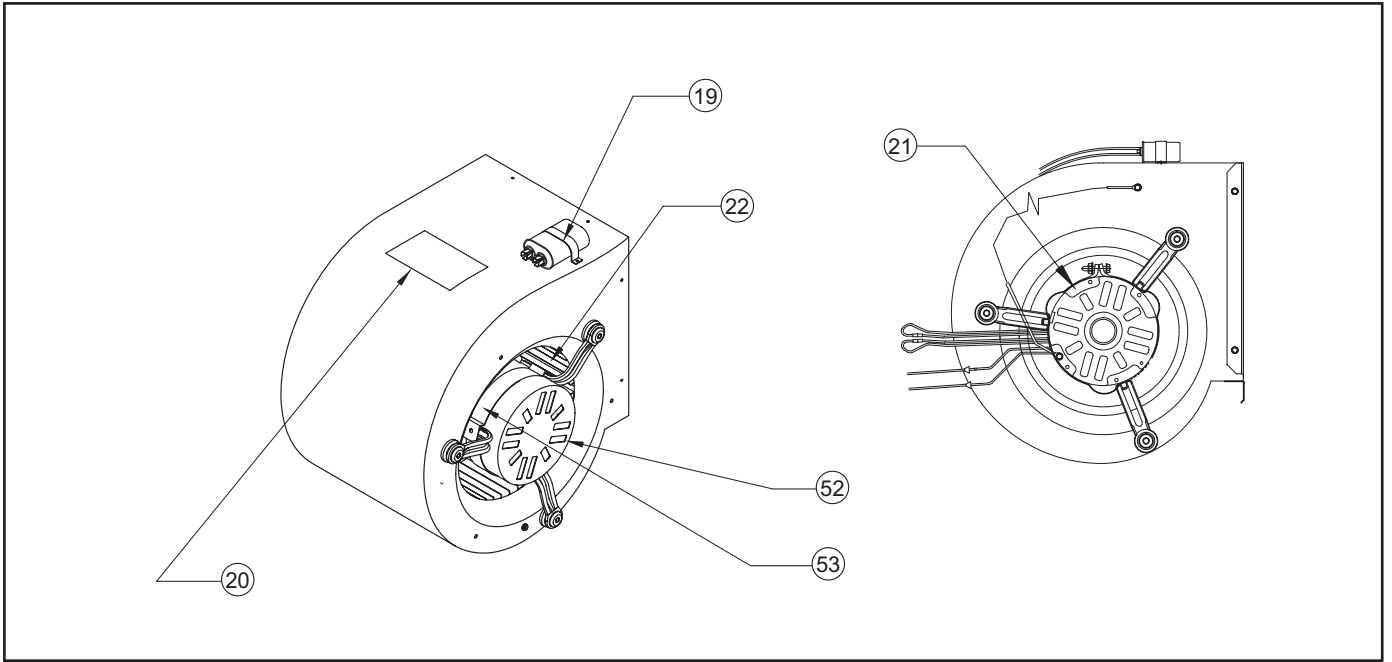

Typical Outdoor Blower

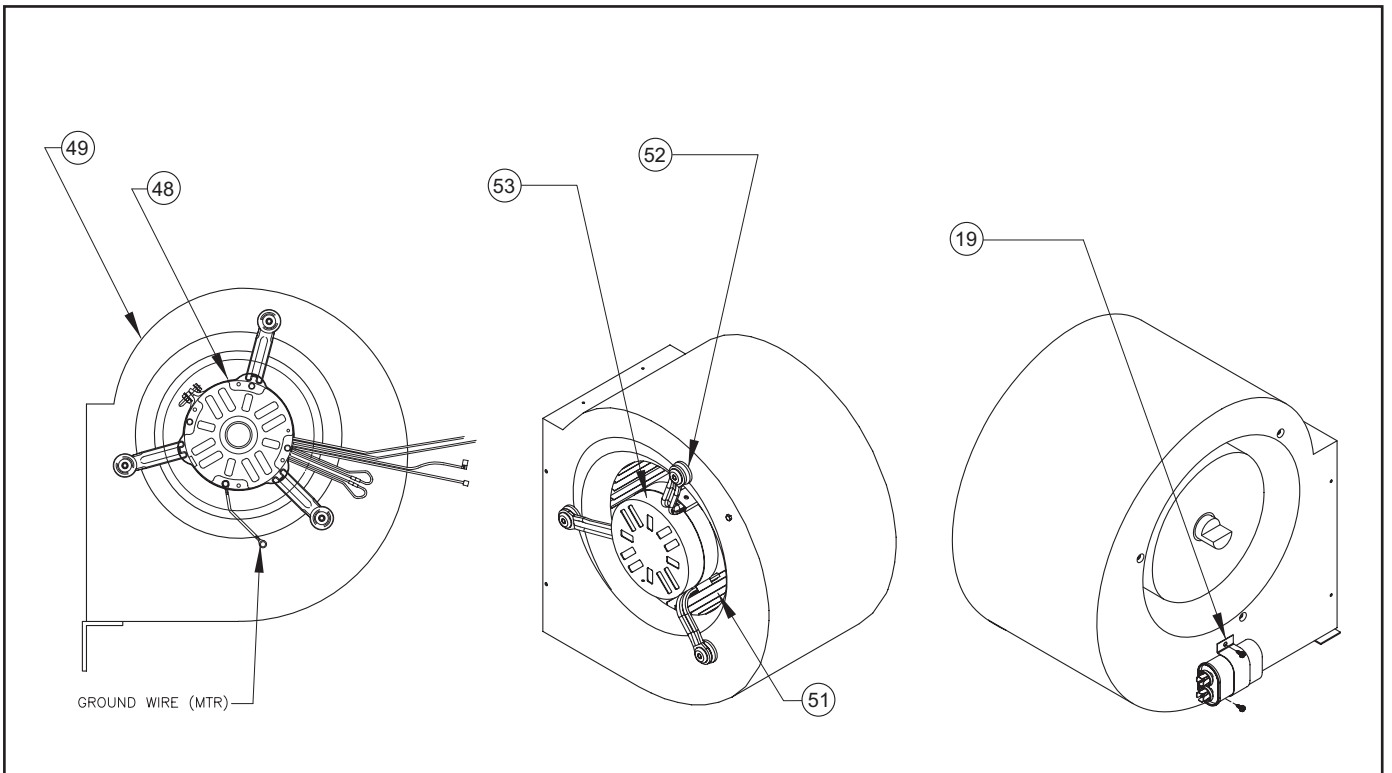

Typical Refrigeration / Condenser Fan - VEB Heat/Cool Models

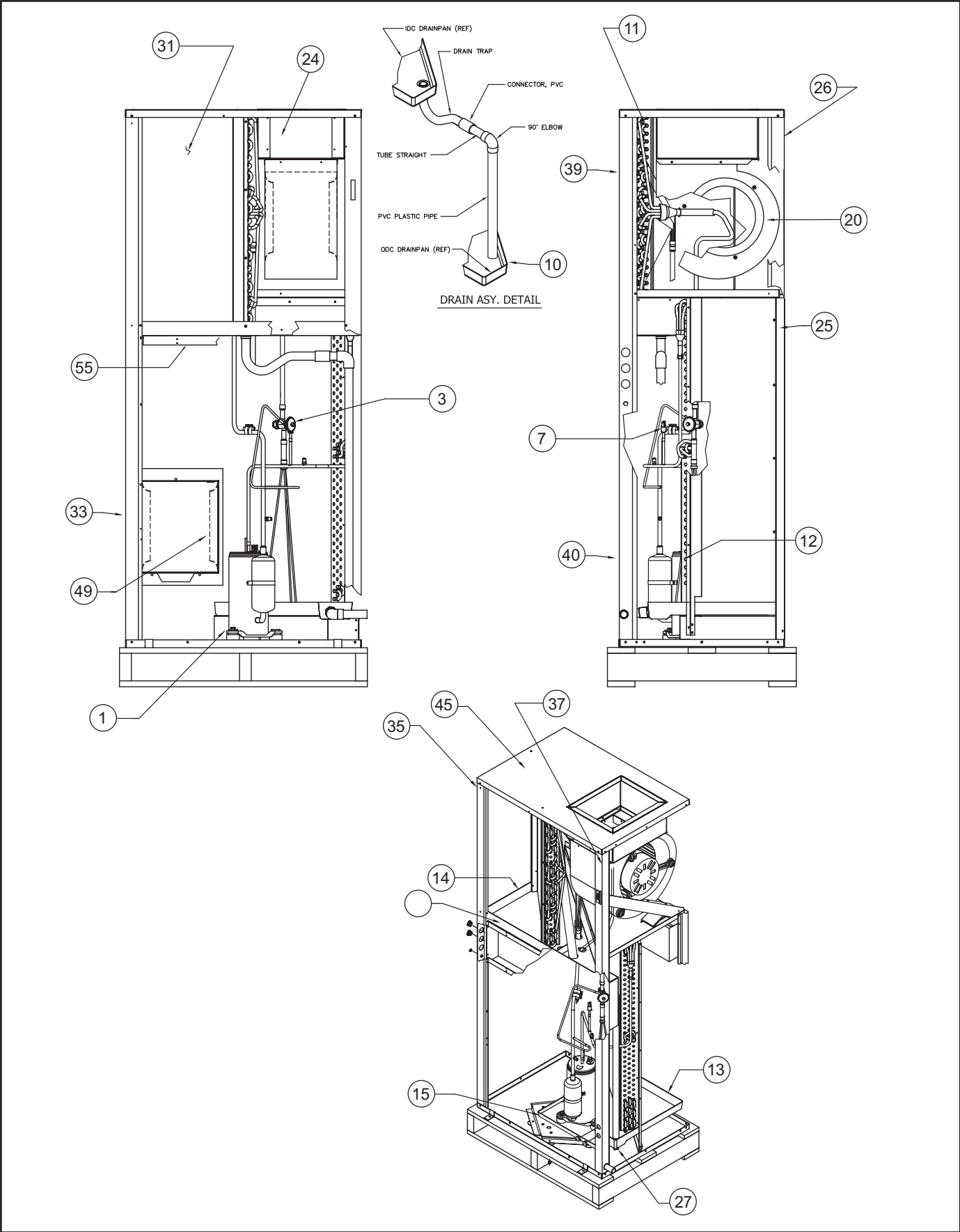

REF.	PART NO.	DESCRIPTION	MODEL						
			VEB18KXX	VEB24KXX	VEB30KXX	VEB36KXX	VEB42KXX	VEB49KXX	VEB60KXX
VERT I PAK B SERIES HEAT/COOL MODELS									
1	25024929	COMPRESSOR	1						
1	25024930	COMPRESSOR		1					
1	61716615	COMPRESSOR			1				
1	08023004	COMPRESSOR				1			
1	08023501	COMPRESSOR					1		
1	08024001	COMPRESSOR						1	
1	08025001	COMPRESSOR							1
3	72015218	BI-FLOW TXV			1	1			
3	72015219	BI-FLOW TXV	1	1					
3	72015220	BI-FLOW TXV					1	1	
3	72015223	BI-FLOW TXV							1
7	24016204	HIGH PRESSURE SWITCH	1	1	1	1	1	1	1
10	60100806	DRAIN LINE ASSEMBLY	1	1	1	1	1	1	1
11	61950014	INDOOR COIL					1		
11	61950013	INDOOR COIL						1	
11	61950012	INDOOR COIL	1	1					
11	61950011	INDOOR COIL			1	1			
11	61950010	INDOOR COIL							1
12	61950100	OUTDOOR COIL				1			
12	61950101	OUTDOOR COIL		1					
12	61950102	OUTDOOR COIL	1		1				
12	61950110	OUTDOOR COIL						1	
12	61959111	OUTDOOR COIL					1		
12	61950122	OUTDOOR COIL							1
13	60020723	OD DRAIN PAN	1	1	1	1			
13	60020737	OD DRAIN PAN					1	1	
13	60020739	OD DRAIN PAN							1
14	60020722	DRAIN PAN INDOOR COIL	1	1	1	1			
14	60020738	DRAIN PAN INDOOR COIL					1	1	1
15	80588001	DRAIN PAN COMPRESSOR	1	1	1	1			
15	80638201	DRAIN PAN COMPRESSOR					1	1	
15	80642700	DRAIN PAN COMPRESSOR							1
18	61080553	COMP CAP ID FAN 25/7.5 440V	1						
18	61080534	COMP CAP ID FAN 35/7.5 370 V		1					
18	61080564	COMP CAP ID FAN 45/10 440V			1				
18	51080562	COMP CAP ID FAN 50/10 370V				1			
18	61080569	COMP CAP ID FAN 60/10 370 V					1		
18	24015520	COMP CAP ID FAN 50/7.5 370 V							
18	24015520	COMPRESSOR CAPACITOR 60						1	1
18	61380319	INDOOR FAN CAPACITOR (60,000 Btu)							1
19	24015509	OD FAN CAPACITOR 5 UF 370V			1				
19	61380319	OD FAN CAPACITOR 7.5 UF 370V	1	1		1	1	1	2
20	80586000	INDOOR BLOWER ASSEMBLY	1	1	1	1			

REF.	PART NO.	DESCRIPTION	MODEL						
			VEB18KXX	VEB24KXX	VEB30KXX	VEB36KXX	VEB42KXX	VEB49KXX	VEB60KXX
VERT I PAK B SERIES HEAT/COOL MODELS									
20	80597301	INDOOR BLOWER ASSEMBLY					1	1	
20	80632900	INDOOR BLOWER ASSEMBLY							1
21	04172001	INDOOR MOTOR					1		
21	04122001	INDOOR MOTOR			1			1	1
21	04231003	INDOOR MOTOR	1	1					
21	04242002	INDOOR MOTOR				1			
22	80569900	INDOOR BLOWER WHEEL DD12-9A CCW							1
22	80570800	INDOOR BLOWER WHEEL 100-8T CCW			1	1			
22	80570900	INDOOR BLOWER WHEEL 11-7R CCW					1	1	
22	80571200	INDOOR BLOWER WHEEL 9X7 CCW	1	1					
24	76001504	HEATER ELEMENT 05 KW	*	*	*	*	*	*	*
24	76001002	HEATER ELEMENT 10 KW	*	*	*	*	*	*	*
24	76001502	HEATER ELEMENT 15 KW	*	*	*	*	*	*	*
24	76002003	HEATER ELEMENT 20 KW	*	*	*	*	*	*	*
24	80623509	HEATER ELEMENT 25 KW	*	*	*	*	*	*	*
25	80624000	INSUL ASSY LOWER REAR PANEL							1
26	80624100	INSUL ASSY UPPER REAR PANEL							1
27	80595500	BASE PAN ASSY INSULATED			1	1	1	1	
27	80595501	BASE PAN ASSY INSULATED	1	1					1
31	80583700	INSUL ASSY REAR PANEL				1			
31	80601300	INSUL ASSY REAR PANEL	1	1					
31	80615700	INSUL ASSY REAR PANEL					1		
31	90609300	INSUL ASSY REAR PANEL			1				
31	80619200	INSUL ASSY REAR PANEL						1	
33	80584500	SIDE PANEL INSULATED	2	2	2	2			2
33	80616300	SIDE PANEL INSULATED					2	2	
35	80623600	INSUL ASSY UPRIGHT LEFT							1
35	80584701	INSUL ASSY UPRIGHT LEFT	1	1	1	1	1	1	
37	80584801	INSUL ASSY UPRIGHT RIGHT	1	1	1	1	1	1	
37	80623700	INSUL ASSY UPRIGHT RIGHT							1
39	80584100	FRONT ACCESS PANEL INS (TOP)	1	1	1	1			
39	80616501	FRONT ACCESS PANEL INS (TOP)					1	1	
39	80621600	FRONT ACCESS PANEL INS (TOP)							1
40	80598300	FRONT ACCESS PANEL INS (BOTTOM)	1	1	1	1			
40	80616601	FRONT ACCESS PANEL INS (BOTTOM)					1	1	
40	80621700	FRONT ACCESS PANEL INS (BOTTOM)							1
45	80595600	INSUL ASSY UNIT TOP PANEL	1	1					
45	80595601	INSUL ASSY UNIT TOP PANEL			1	1			
45	80616800	INSUL ASSY UNIT TOP PANEL					1	1	
45	80621800	INSUL ASSY UNIT TOP PANEL							1
48	04132002	OUTDOOR MOTOR						2	2
48	04172001	OUTDOOR MOTOR					1		
48	04231003	OUTDOOR MOTOR	1	1					
48	04222001	OUTDOOR MOTOR				1			
48	04232002	OUTDOOR MOTOR			1				

* NOTE: Heater Kw MUST be identified first for part number.

REF.	PART NO.	DESCRIPTION	MODEL							
			VEB18KXX	VEB24KXX	VEB30KXX	VEB36KXX	VEB42KXX	VEB49KXX	VEB60KXX	
VERT I PAK B SERIES HEAT/COOL MODELS										
49	80597400	OUTDOOR BLOWER ASSEMBLY	1	1	1	1				
49	80597401	OUTDOOR BLOWER ASSEMBLY					1			
49	80597402	OUTDOOR BLOWER ASSEMBLY							1	
49	80597403	OUTDOOR BLOWER ASSEMBLY						1	1	
51	80571200	OUTDOOR BLOWER WHEEL 9X7 CCW						1	1	
51	80570800	OUTDOOR BLOWER WHEEL 110-8T CCW	1	1	1	1				
51	80570700	OUTDOOR BLOWER WHEEL 1100-8T CW					1			
51	80571100	OUTDOOR BLOWER 90-7R CW							1	
52	04144501	MOTOR MTG. ASSY			3	3	3			
52	04144502	MOTOR MTG. ASSY	3	3				3	3	
53	04144401	MOTOR BAND	1	1	1	1	1	1	1	
54	80588800	RISER CIRCUIT BREAKER	1	1	1	1			1	
54	80588802	RISER CIRCUIT BREAKER					1	1		
55	80595900	CONTROL BOX	1	1	1	1				
55	80595902	CONTROL BOX							1	
55	80595903	CONTROL BOX					1	1		
56	24015304	20 AMP BREAKER	1							
56	24015313	25 AMP BREAKER		1						
56	24015302	30 AMP BREAKER			1	1				
56	24015305	40 AMP BREAKER			1	1				
56	24015312	50 AMP BREAKER					1			
56	24015301	60 AMP BREAKER	1	1	1	1	1	2	3	
61	24015203	CONTACTOR 30 AMP	1	1	1	1	1	1	1	
62	24015202	CONTACTOR 40 AMP	1	1	1	1	1	2	3	
63	033219	CONTROL TRANSFORMER	1	1	1	1	1	1	1	
69	24016102	SINGLE POINT POWER BLOCK	1	1	1	1	1	1	1	
72	32015302	GROUND LUG	1	1	1	1	1	1	1	
73	24015100	POST PURGE FAN DELAY TIMER	1	1	1	1	1	1	1	
74	24015905	TERMINAL BLOCK THERMOSTAT	1	1	1	1	1	1	1	
75	24015906	TERMINAL BLOCK	1	1	1	1	1	1	1	
N/S	61764522	COMPRESSOR OVERLOAD	1							
N/S	68183801	SOLID STATE START ASSIST DEVICE	1	1	1	1	1	1	1	
N/S	24016208	FREEZE-STAT	1	1	1	1	1	1	1	
N/S	24016212	THERMAL LIMIT	1	1	1	1	1	2	2	
N/S	61656201	SLIDE EXHAUST DOOR	1	1	1	1	1	1	1	
N/S	61656200	CHANNEL EXHAUST DOOR	1	1	1	1	1	1	1	
N/S	61814802	CONNECTOR FRESH AIR DOOR CONTR	1	1	1	1	1	1	1	
N/S	61613600	SPRING FRESH AIR	1	1	1	1	1	1	1	
N/S	61610400	PIN HINGE FRESH AIR	1	1	1	1	1	1	1	
N/S	61358301	ASY DOOR INSUL	1	1	1	1	1	1	1	
N/S	80589201	SUPPORT DAMPER CABLE	1	1	1	1	1	1	1	
N/S	85089202	SUPPORT DAMPER CABLE	1	1	1	1	1	1	1	
N/S	88010110	FILTER	1	1	1	1	1	1	1	
N/S	80597200	CONTROL BOX COVER	1	1	1	1	1	1	1	
N/S	VPDPH5	COLD CLIMATE KIT (18,000 - 36,000 Btu)	1	1	1	1				
N/S	VPDPH6	COLD CLIMATE KIT (42,000 - 60,000 Btu)					1	1	1	
N/S	77000001	OUTDOOR DRAIN LINE HEATER ALL (VPDLH1)	1	1	1	1	1	1	1	

Typical Refrigeration / Condenser Fan - VHB Heat Pump Models

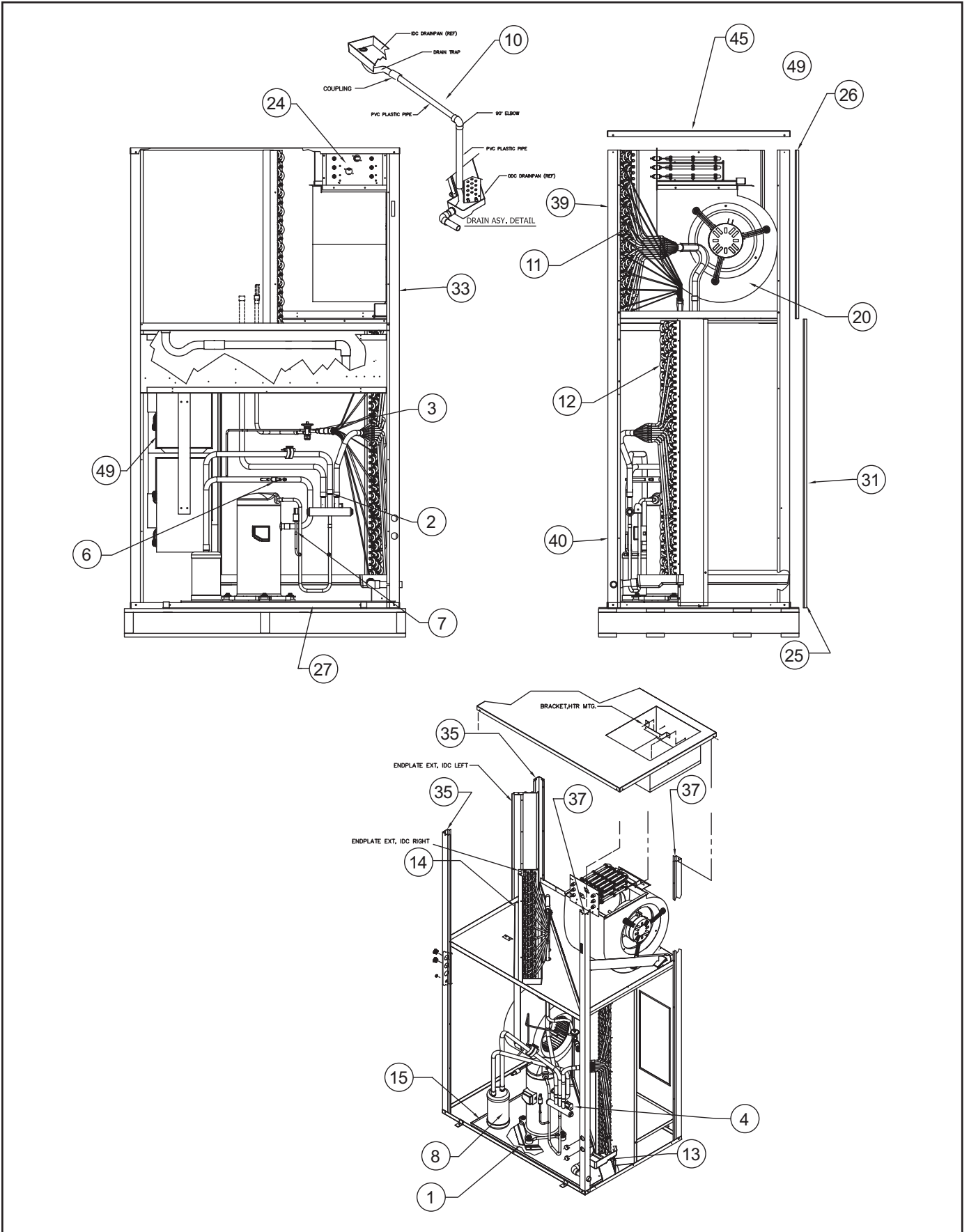

REF.	PART NO.	DESCRIPTION	MODEL						
			VHB18KXX	VHB24KXX	VHB30KXX	VHB36KXX	VHB42KXX	VHB49KXX	VHB60KXX
VERT I PAK B SERIES PARTS HEAT PUMP MODELS									
1	25024929	COMPRESSOR	1						
1	25024930	COMPRESSOR		1					
1	61716615	COMPRESSOR			1				
1	08023004	COMPRESSOR				1			
1	08023501	COMPRESSOR					1		
1	08024001	COMPRESSOR						1	
1	08025001	COMPRESSOR							1
2	80552800	REVERSING VALVE			1	1	1	1	
2	80552801	REVERSING VALVE							1
2	25018701	REVERSING VALVE	1	1					
3	72015218	BI-FLOW TXV			1	1			
3	72015219	BI-FLOW TXV	1	1					
3	72015220	BI-FLOW TXV					1	1	
3	72015223	BI-FLOW TXV							1
4	80568100	R/V SOLENOID COIL 24 VOLT	1	1	1	1	1	1	1
6	24016206	LOW PRESSURE SWITCH	1	1	1	1	1	1	1
7	24016204	HIGH PRESSURE SWITCH	1	1	1	1	1	1	1
8	61661103	ACCUMULTOR							1
8	61661104	ACCUMULTOR	1	1	1	1	1	1	
10	60100806	DRAIN LINE ASSEMBLY	1	1	1	1	1	1	1
11	61950014	INDOOR COIL					1		
11	61950013	INDOOR COIL						1	
11	61950012	INDOOR COIL	1	1					
11	61950011	INDOOR COIL			1	1			
11	61950010	INDOOR COIL							1
12	61950100	OUTDOOR COIL				1			
12	61950101	OUTDOOR COIL		1					
12	61950102	OUTDOOR COIL	1		1				
12	61950110	OUTDOOR COIL						1	
12	61959111	OUTDOOR COIL					1		
12	61950122	OUTDOOR COIL							1
13	60020735	OD DRAIN PAN	1	1	1	1			
13	60020737	OD DRAIN PAN					1	1	
13	60020739	OD DRAIN PAN							1
14	60020736	DRAIN PAN INDOOR COIL	1	1	1	1			
14	60020738	DRAIN PAN INDOOR COIL					1	1	1
15	80596400	DRAIN PAN COMPRESSOR	1	1	1	1			
15	80638201	DRAIN PAN COMPRESSOR					1	1	
15	80642700	DRAIN PAN COMPRESSOR							1
18	61080553	COMP CAP ID FAN 25/7.5 440V	1						
18	61080534	COMP CAP ID FAN 35/7.5 370 V		1					
18	61080564	COMP CAP ID FAN 45/10 440V			1				
18	51080562	COMP CAP ID FAN 50/10 370V				1			
18	61080569	COMP CAP ID FAN 60/10 370 V					1		
18	24015520	COMP CAP ID FAN 50/7.5 370 V						1	
18	24015520	COMPRESSOR CAPACITOR 60							1
18	61380319	INDOOR FAN CAPACITOR (60,000 Btu)							1

REF.	PART NO.	DESCRIPTION	MODEL							
			VHB18KXX	VHB24KXX	VHB30KXX	VHB36KXX	VHB42KXX	VHB49KXX	VHB60KXX	
VERT I PAK B SERIES PARTS HEAT PUMP MODELS										
19	24015509	OD FAN CAPACITOR 5 UF 370V			1					
19	61380319	OD FAN CAPACITOR 7.5 UF 370V	1	1		1	1	1	2	
20	80597300	INDOOR BLOWER ASSEMBLY	1	1	1	1				
20	80597301	INDOOR BLOWER ASSEMBLY					1	1		
20	80632900	INDOOR BLOWER ASSEMBLY							1	
21	04172001	INDOOR MOTOR					1			
21	04122001	INDOOR MOTOR						1	1	
21	04231003	INDOOR MOTOR	1	1						
21	04242002	INDOOR MOTOR			1	1				
22	80569900	INDOOR BLOWER WHEEL DD12-9A CCW							1	
22	80570800	INDOOR BLOWER WHEEL 100-8T CCW			1	1				
22	80570900	INDOOR BLOWER WHEEL 11-7R CCW					1	1		
22	80571200	INDOOR BLOWER WHEEL 9X7 CCW	1	1						
24	76001504	HEATER ELEMENT 05 KW	*	*	*	*	*	*	*	*
24	76001002	HEATER ELEMENT 10 KW	*	*	*	*	*	*	*	*
24	76001502	HEATER ELEMENT 15 KW	*	*	*	*	*	*	*	*
24	76002003	HEATER ELEMENT 20 KW	*	*	*	*	*	*	*	*
24	80623509	HEATER ELEMENT 25 KW	*	*	*	*	*	*	*	*
25	80624000	INSUL ASSY LOWER REAR PANEL							1	
26	80624100	INSUL ASSY UPPER REAR PANEL							1	
27	80595500	BASE PAN ASSY INSULATED			1	1	1	1		
27	80595501	BASE PAN ASSY INSULATED	1	1					1	
31	80583700	INSUL ASSY REAR PANEL				1				
31	80601300	INSUL ASSY REAR PANEL	1	1						
31	80615700	INSUL ASSY REAR PANEL					1			
31	90609300	INSUL ASSY REAR PANEL			1					
31	80619200	INSUL ASSY REAR PANEL						1		
33	80584500	SIDE PANEL INSULATED	2	2	2	2			2	
33	80616300	SIDE PANEL INSULATED					2	2		
35	80623600	INSUL ASSY UPRIGHT LEFT							1	
35	80584701	INSUL ASSY UPRIGHT LEFT	1	1	1	1	1	1		
37	80584801	INSUL ASSY UPRIGHT RIGHT	1	1	1	1	1	1		
37	80623700	INSUL ASSY UPRIGHT RIGHT							1	
39	80584100	FRONT ACCESS PANEL INS (TOP)	1	1	1	1				
39	80616501	FRONT ACCESS PANEL INS (TOP)					1	1		
39	80621600	FRONT ACCESS PANEL INS (TOP)							1	
40	80598300	FRONT ACCESS PANEL INS (BOTTOM)	1	1	1	1				
40	80616601	FRONT ACCESS PANEL INS (BOTTOM)					1	1		
40	80621700	FRONT ACCESS PANEL INS (BOTTOM)							1	
45	80595600	INSUL ASSY UNIT TOP PANEL	1	1						
45	80595601	INSUL ASSY UNIT TOP PANEL			1	1				
45	80616800	INSUL ASSY UNIT TOP PANEL					1	1		
45	80621800	INSUL ASSY UNIT TOP PANEL							1	
48	04132002	OUTDOOR MOTOR						2	2	
48	04172001	OUTDOOR MOTOR					1			
48	04231003	OUTDOOR MOTOR	1	1						
48	04222001	OUTDOOR MOTOR				1				
48	04232002	OUTDOOR MOTOR			1					
49	80597400	OUTDOOR BLOWER ASSEMBLY	1	1	1	1				

* NOTE: Heater Kw MUST be identified first for part number.

REF.	PART NO.	DESCRIPTION	MODEL						
			VHB18KXX	VHB24KXX	VHB30KXX	VHB36KXX	VHB42KXX	VHB49KXX	VHB60KXX
VERT I PAK B SERIES PARTS HEAT PUMP MODELS									
49	80597401	OUTDOOR BLOWER ASSEMBLY					1		
49	80597402	OUTDOOR BLOWER ASSEMBLY							1
49	80597403	OUTDOOR BLOWER ASSEMBLY					1	1	
51	80571200	OUTDOOR BLOWER WHEEL 9X7 CCW					1	1	
51	80570800	OUTDOOR BLOWER WHEEL 110-8T CCW	1	1	1	1			
51	80570700	OUTDOOR BLOWER WHEEL 1100-8T CW					1		
51	80571100	OUTDOOR BLOWER 90-7R CW							1
52	04144501	MOTOR MTG. ASSY			3	3	3		
52	04144502	MOTOR MTG. ASSY	3	3				3	3
53	04144401	MOTOR BAND	1	1	1	1	1	1	1
54	80588800	RISER CIRCUIT BREAKER	1	1	1	1			1
54	80588802	RISER CIRCUIT BREAKER					1	1	
55	80595900	CONTROL BOX	1	1	1	1			
55	80595902	CONTROL BOX							1
55	80595903	CONTROL BOX					1	1	
56	24015304	20 AMP BREAKER	1						
56	24015313	25 AMP BREAKER		1					
56	24015302	30 AMP BREAKER			1	1			
56	24015305	40 AMP BREAKER			1	1			
56	24015312	50 AMP BREAKER					1		
56	24015301	60 AMP BREAKER	1	1	1	1	1	2	3
61	24015203	CONTACTOR 30 AMP	1	1	1	1	1	1	
61	24015202	CONTACTOR 40 AMP	1	1	1	1	1	2	3
63	033219	CONTROL TRANSFORMER	1	1	1	1	1	1	1
64	24015401	HEAT PUMP DEFROST CONTROL	1	1	1	1	1	1	1
65	24016207	DEFROST THERMOSTAT	1	1	1	1	1	1	1
67	24015000	DEFROST RELAY / HTR RELAY	1	1	1	1	1	1	1
68	24015000	EMERGENCY HEAT RELAY	1	1	1	1	1	1	1
69	24016102	SINGLE POINT POWER BLOCK	1	1	1	1	1	1	1
72	32015302	GROUND LUG	1	1	1	1	1	1	1
73	24015100	POST PURGE FAN	1	1	1	1	1	1	1
74	24015905	TERMINAL BLOCK THERMOSTAT	1	1	1	1	1	1	1
75	24015906	TERMINAL BLOCK	1	1	1	1	1	1	1
N/S	61764522	COMPRESSOR OVERLOAD	1						
N/S	61883801	SOLID STATE START ASSIST DEVICE	1	1	1	1	1	1	1
N/S	24016208	FREEZE-STAT	1	1	1	1	1	1	1
N/S	24016212	THERMAL LIMIT	1	1	1	1	1	2	2
N/S	61656201	SLIDE EXHAUST DOOR	1	1	1	1	1	1	1
N/S	61656200	CHANNEL EXHAUST DOOR	1	1	1	1	1	1	1
N/S	61814802	CONNECTOR FRESH AIR DOOR CONTR	1	1	1	1	1	1	1
N/S	61613600	SPRING FRESH AIR	1	1	1	1	1	1	1
N/S	61610400	PIN HINGE FRESH AIR	1	1	1	1	1	1	1
N/S	61358301	ASY DOOR INSUL	1	1	1	1	1	1	1
N/S	80589201	SUPPORT DAMPER CABLE	1	1	1	1	1	1	1
N/S	85089202	SUPPORT DAMPER CABLE	1	1	1	1	1	1	1
N/S	88010110	FILTER	1	1	1	1	1	1	1
N/S	VPDPH5	COLD CLIMATE KIT (18,000 - 36,000 Btu)	1	1	1	1			
N/S	VPDPH6	COLD CLIMATE KIT (42,000 - 60,000 Btu)					1	1	1
N/S	77000001	OUTDOOR DRAIN LINE HEATER ALL (VPDLH1)	1	1	1	1	1	1	1
NS	80597200	CONTROL BOX COVER	1	1	1	1	1	1	1



Friedrich Air Conditioning Co.
Post Office Box 1540 • San Antonio, Texas 78295-1540
4200 N. Pan Am Expressway • San Antonio, Texas 78218-5212
(210) 357-4400 • FAX (210) 357-4480
www.friedrich.com

Printed in the U.S.A.

VPAK-B-PARTS-RTB-RTC-05 (7-05)