

This Owner's Manual is provided and hosted by [Appliance Factory Parts](#).

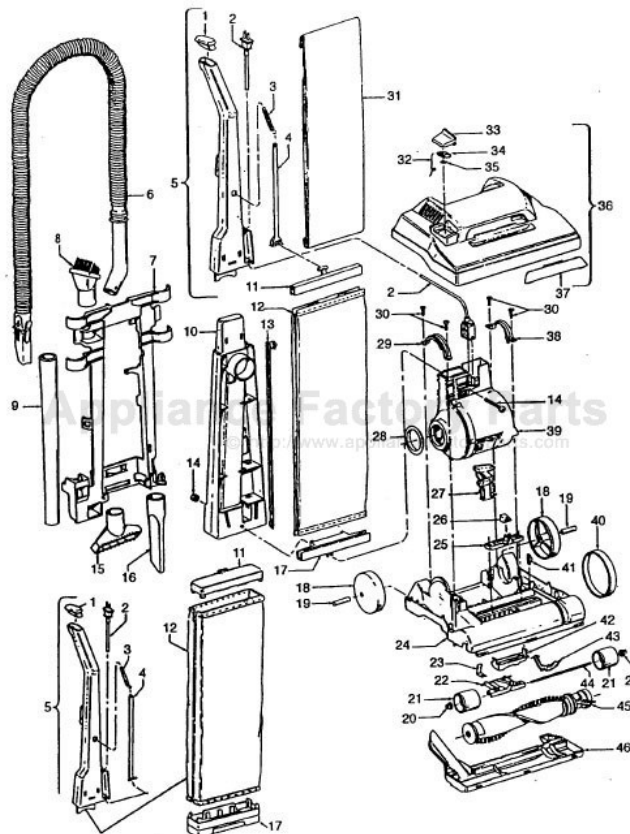

HOOVER U4267-930 Owner's Manual

[Shop genuine replacement parts for HOOVER
U4267-930](#)



[Find Your HOOVER Vacuum Cleaner Parts - Select From 1456 Models](#)

----- Manual continues below part list -----

Available Replacement Parts for HOOVER U4267-930

H-38528040	BELT VACUUM HOOVER OEM (1 PACK)
48414036	HOOVER ELITE BRUSH ROLLER
H-4010001A	VACUUM BAG OEM HOOVER 3 PACK
H-43267002	AGITATOR BEARING ASM
K-109289	BULB

Elite II

Sprint
TurboPOWER

Models U4261-910, U4261-930, U4261-940, U4261-980 *,
U4261-990 **, U4263-930, U4265-910, U4265-930,
U4267-930, U4269-930, U4271-930***, U4271-980****
Model U4259-930
Model U4645-930

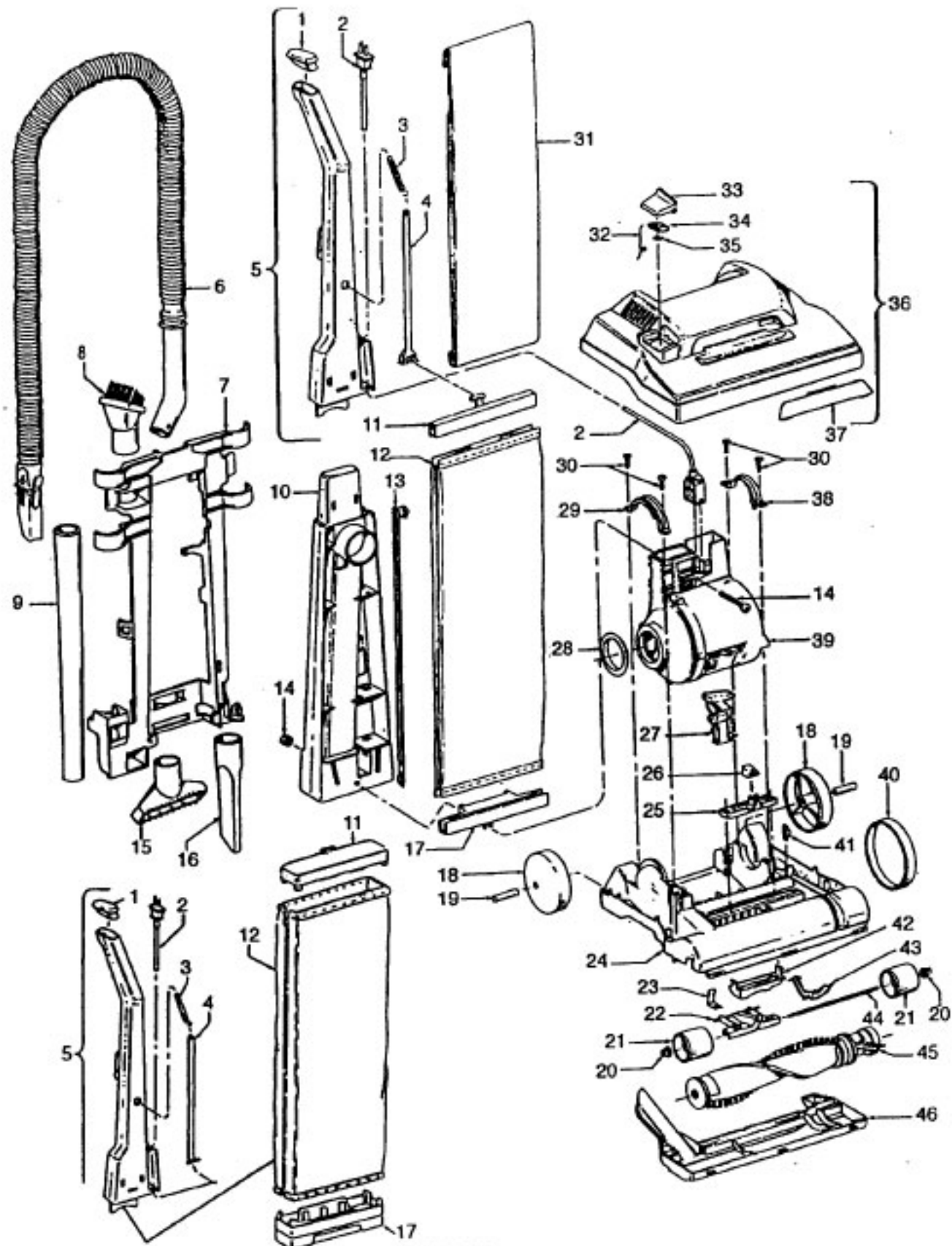

USED ON MODELS U4263-930, U4269-930
U4259-930, U4271-930, U4645-930

Elite II

Models U4261-910, U4261-930, U4261-940, U4261-980 *, U4261-990 **,
U4263-930, U4265-910, U4265-930, U4267-930, U4269-930, U4271-930 ***,
U4271-980 ****

Sprint
TurboPOWER

Model U4259-930
Model U4645-930

Ref. No.	Part No.	Description	Ref. No.	Part No.	Description
1	37911079	Handle Cap - ABE	36	42252318	Hood Assem. - ABN
2	46388027	Attach. Cord - AG		42252327	Hood Assem. - ABP - U4265-910
3	38335020	Bag Strap Spring - AY		42252334	Hood Assem. - ABP - U4265-930
4	36425072	Bag Strap - MW - U4263-930; U4269-930 U4271-930, U4259-930		42252337	Hood Assem. - ABN - U4263-930
	36425071	Bag Strap - ABE		42252342	Hood Assem. - ABN - U4261-930, U4261-980
5	48663142	Upper Handle Assem. - MW		42252352	Hood Assem. - ABT - U4261-940
	48663141	Upper Handle Assem. - MW - U4263-930, U4269-930, U4271-930, U4259-930, U4645-930		42252361	Hood Assem. - ABP - U4267 - 930
				42252379	Hood Assem. - ABE - U4269-930
6	43434237	Hose Assem. - ABX/AG		42252392	Hood Assem. - ABP - U4259-930
7	36433110	Tool Rack - MW - Models with two wands		42252397	Hood Assem. - MD - U4271-930
	36433098	Tool Rack - ABE - Models with one wand		42252A02	Hood Assem. - AG - U4645-930
8	43414145	Dusting Brush - AG		42252A82	Hood Assem. - AG - U4269-930 after 08/16/99.
9	38634078	Extension Tube - AG	37	37246048	Panel - ABN
10	39464005	Lower Handle- ABE		37246126	Panel - ABP- U4265-910, U4265-930
11	36425064	Jacket Support - Upper - ABE - U4263-930; U4269-930, U4271-930, U4259-930, U4645-930		37246128	Panel - ABT - U4261-940
	36425067	Jacket Support - Upper - ABE - U4267-930		39383099	Lens - BZ - U4263-930, U4267-930, U4271-930, U4259-930
12	43674191	Outer Jacket - Sewn - AAP/MN		39383098	Lens U4269-930, U4645-930
	43674191	Jacket Assem. - Common- ABP-U4267-930	38	36131090	Motor Retainer Cap - L.H.
	43686182	Outer Jacket - ABN - U4263-930 (Incl. It. 11, 17)	39	43576141	Motor - (P - 201)
	43686162	Outer Jacket-AG (Incl. It. 11, 17) U4269-930		43576142	Motor - (P - 202) - U4263-930, U4267-930 U4269-930, U4271-930, U4259-930 U4645-930
	43686014	Outer Jacket - MD U4271-930	40	38528027	Belt
	43686208	Outer Jacket - ABP U4259-930	41	13261AY	Rug Nozzle Rib Shoe
	43686212	Outer Jacket - AG U4645-930	42	38563011	Nozzle Height Adj. Cam
	43686225	Outer Jacket (Incl. It. 11, 17) - U4645-930 after 08/06/99.	43	38452089	Lever (Use wheel assem. 43248059)
	43686228	Outer Jacket (Incl. It. 11, 17) - U4269-930 after 08/16/99.	44	32563012	Wheel Shaft - AY (Use 43248059)
13	38456036	Switch Control Rod - ABB	45	48414079	Agitator Comp. - (P - 203)
14	40201085	Nut & Bolt		48414081	Agitator Comp. - U4269-930 (P - 204)
15	38614029	Furniture Nozzle - AG	46	37245108	Bottom Plate - MW
16	38617024	Crevice Tool - AG		37245017	Bottom Plate - AG U4259-930
17	36425063	Jacket Support - Lower - ABE -U4263-930 U4269-930, U4271-930, U4259-930, U4645-930		37245108	Bottom Plate - AG U4645-930
	36425068	Jacket Support - Lower - ABE - U4267-930	ITEMS NOT ILLUSTRATED		
18	38522011	Rear Wheel - AG		3944201P	Cord Wrap
19	31523012	Rear Wheel Shaft - AY		27313101	Dirt Finder Lamp - U4263-930, U4267-930, U4269-930, U4271-930, U4259-930
20	36131056	Wheel Retainer	PACKAGING MATERIAL		
21	N/A	Wheel - AG - (Use 43248059 Wheel Assem.)		56511A64	Owner Manual - U4645-930 (after 08/06/99)
22	43248059	Front Wheel Assem. (Incl. It. 21, 43, 44)		56511A33	Owner Manual - U4263-930, U4271-930, U4269-930, U4259-930, U4645-930
23	34572002	Cam Actuator Spring		56511394	Owner Manual- U4261-930, U4261-940, U4261-980, U4265-930 (before 08/06/99), U4267-930
24	42243002	Main Body Assem. (Incl. It. 18, 19, 27, 41)		58185184	Carton - Common
	42243001	Main Body Assem. (Incl. It. 18, 19, 27, 41) U4269-930, U4645-930		58258008	Carton Support - U4261-990
25	38567008	Cam Actuator - MW		58346004	Front Support
26	38421070	Indicator Knob - ABE		58366096	Front Support - U4261-980
27	38458022	Handle Release Lever		58353009	Rear Support
28	38784016	Seal		58366097	Rear Support - U4261-980
29	36131057	Motor Retainer Cap - R.H.		58347019	Cleaning Tool Carton
30	21447217	Screw - Self Tapping		58347022	Cleaning Tool Carton - U4271-930, U4263-930
31	4010001A	Throw Away Bag (3 Pk.)	* NOTE: Model U4261-980 is an ensemble which includes the Model U4261-930 Encore Supreme Upright and a Model S1103 Dubl-Duty Wet/Dry Hand Cleaner.		
	4010100A	Allergen Throw Away Bag (3 Pk.)	** NOTE: Model U4261-990 is an ensemble which includes the Model U4261-940 Encore Supreme Upright, a Model S2141 Quik-Broom and a Model S1137 Brush-Vac Hand Cleaner.		
32	38351013	Spring	*** Note: Model U4271-930 has a new style door and does not require the use of the Seal and Speed Nut.		
33	37257042	Door Assem. - ABN (Incl. It. 34, 35)	****Note: Model U4271-980 is an ensemble which includes the model U4271-930 and a model S1103 Dubl-Duty.		
	37257043	Door Assem. - ABP - U4265-910, U4265-930, U4267-930 (Incl. It. 34, 35)			
	37257063	Door Assem. - ABT - U4261-940 (Incl. Items 34, 35)			
	37257028	Door Assem. - ABE - U4269-930 (Incl. It. 34, 35)			
	37257017	Door Assem. - MD See NOTE ***, U4271-930			
	37257047	Door Assem. - ABP- U4259-930 Incl. It. 34, 35			
	37257143	Door Assem. - AG - U4645-930 See Note ***			
34	38785011	Seal (See Note ***)			
35	21362006	Speed Nut (See Note ***)			

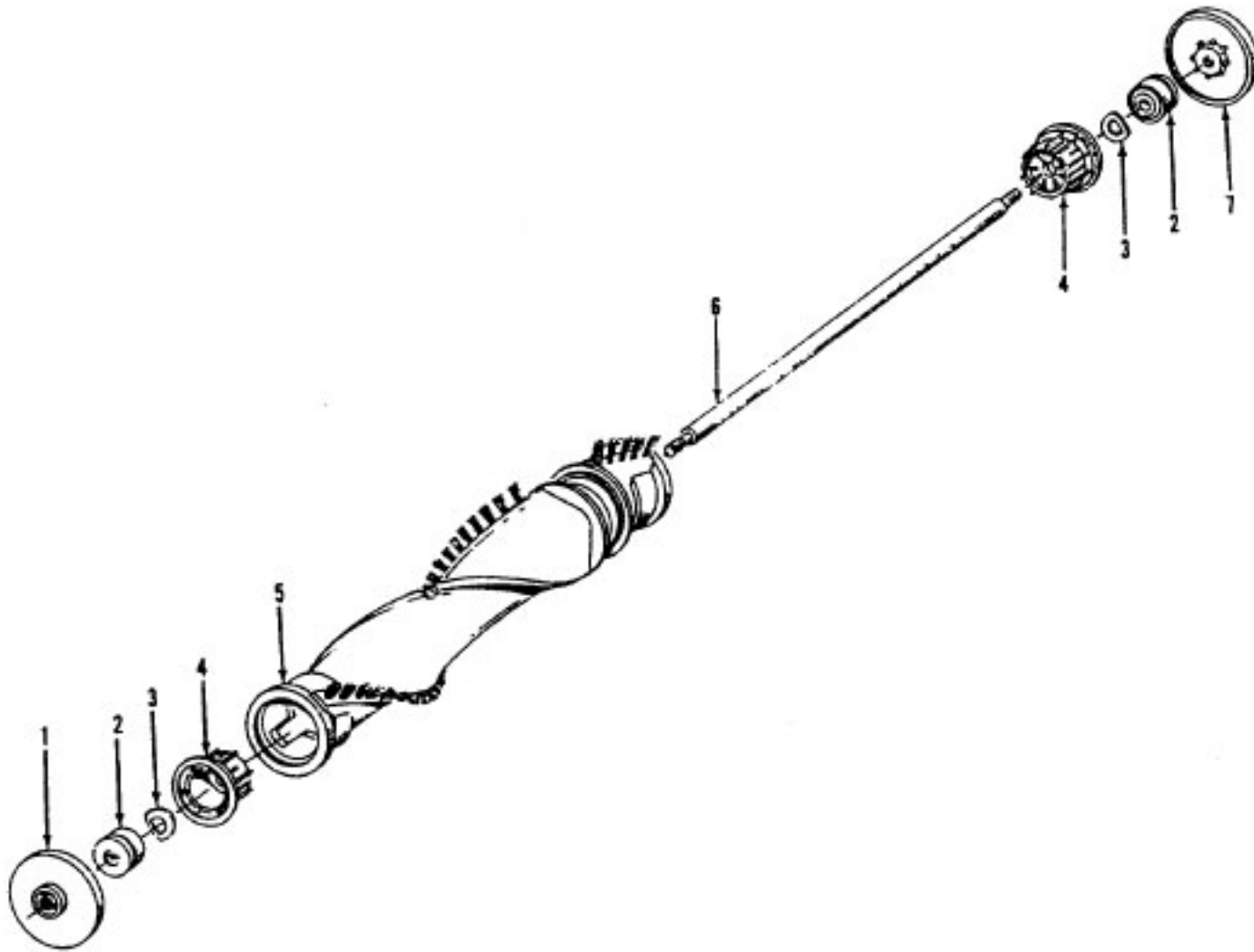

Ref. No.	Part No.	Description
	48414079	Agitator Assem. Comp. - AG
1	36423016	Thread Guard - RH
2	43267002	Agitator Bearing Assem. (2)
3	21347003	Conical Washer (2)
4	36422022	Agitator End (2)
5	N/A	Agitator Body
6	32724013	Agitator Shaft
7	36423017	Thread Guard - LH - AG

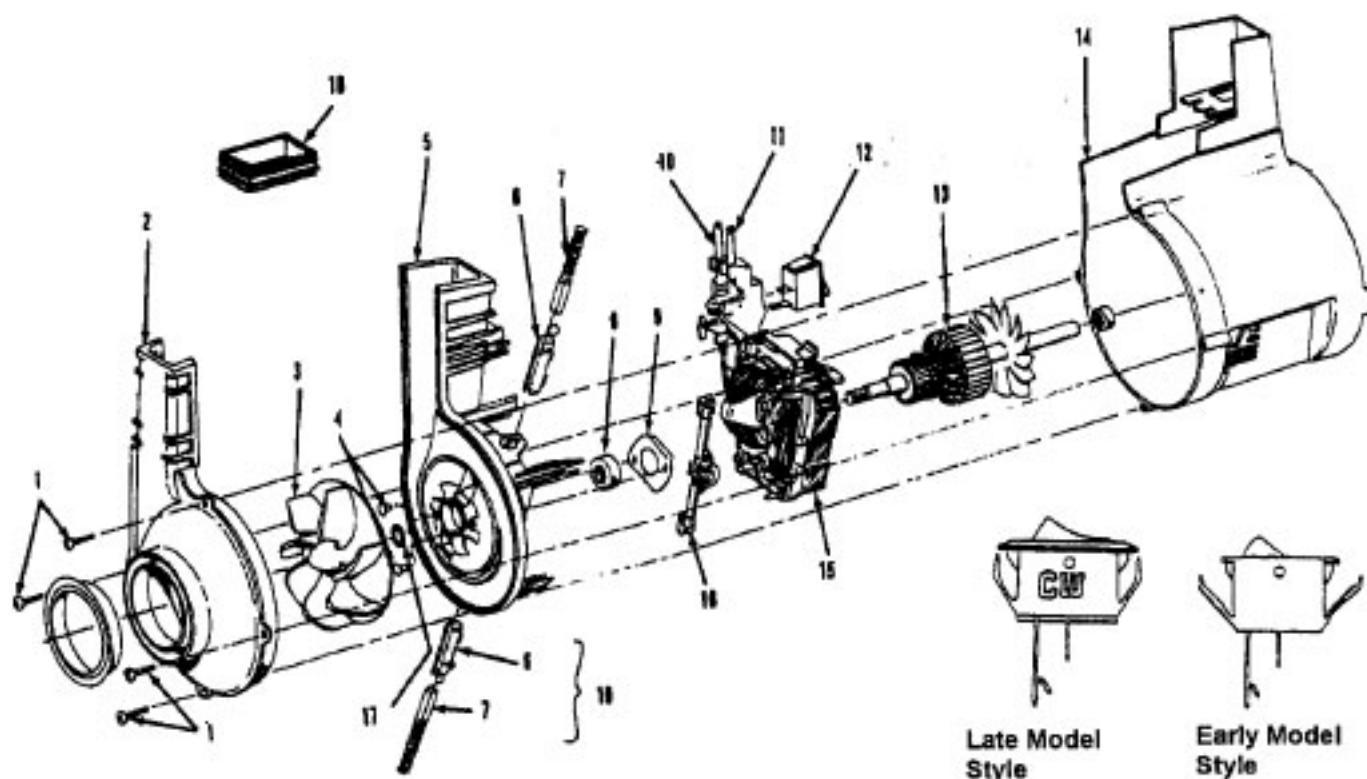

Ref. No.	Part No.	Description
	43576142	Motor Assem. Comp.
	43576181	Motor Assem. Comp. (Replaced by 43576204)
1	214793DA	Screw-Self Tapping (4)
2	38736033	Fan Chamber
3	38755030	Fan
4	N/A	Rivet - Semi Tubular (2)
5	N/A	Motor Housing Assem.
6	N/A	Motor Brush Holder (2)
7	N/A	Motor Brush Assem. (2)
8	N/A	Bearing
9	N/A	Bearing Retainer
10	36914004	Switch Bus Bar
11	39116005	Attachment Terminal
12	28218043	Switch Assem. - Early Models (Prior to 5/96)
	28161062	Switch Assem. - Late Models (After 5/96)
13	N/A	Armature/Bearing Assem.
14	37194046	Motor End Cap Assem. - MW
15	N/A	Field Assem.
16	N/A	Lamp Holder Assem.
17	21312793	Washer
18	38783020	Duct Seal
19	41311016	Motor Brush Holder Assem.

ITEMS NOT ILLUSTRATED

38781013	Duct Seal (8 1/2" Long adhesive backed foam seal used on early models in place of item 18)
54821001	Tape (Roll)