

This Owner's Manual is provided and hosted by Appliance Factory Parts.

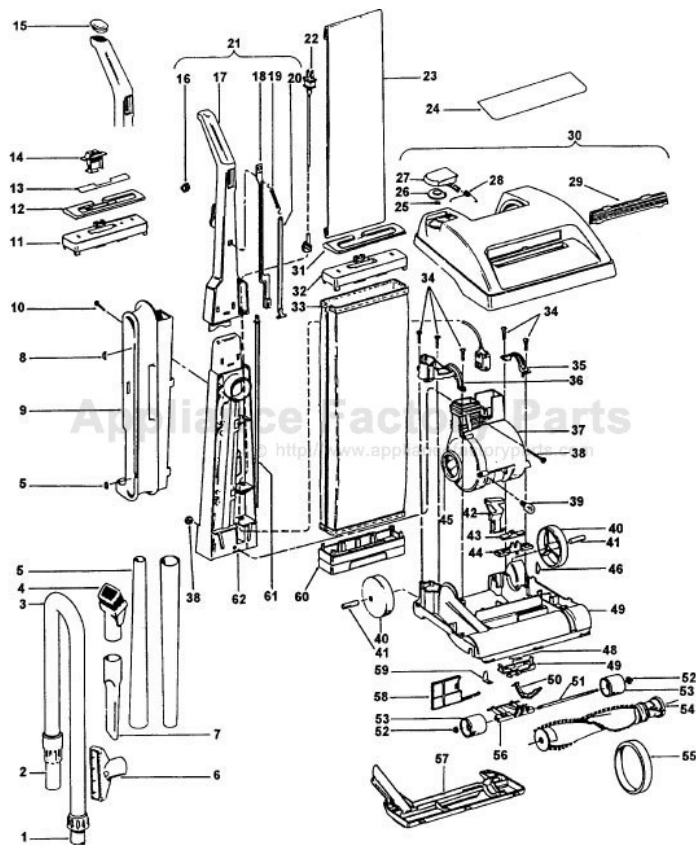

HOOVER U4537-930 Owner's Manual

[Shop genuine replacement parts for HOOVER
U4537-930](#)



[Find Your HOOVER Vacuum Cleaner Parts - Select From 1456 Models](#)

----- Manual continues below part list -----

Available Replacement Parts for HOOVER U4537-930

H-38528040	BELT VACUUM HOOVER OEM (1 PACK)
48414036	HOOVER ELITE BRUSH ROLLER
H-4010001A	VACUUM BAG OEM HOOVER 3 PACK
H-43267002	AGITATOR BEARING ASM
K-109289	BULB

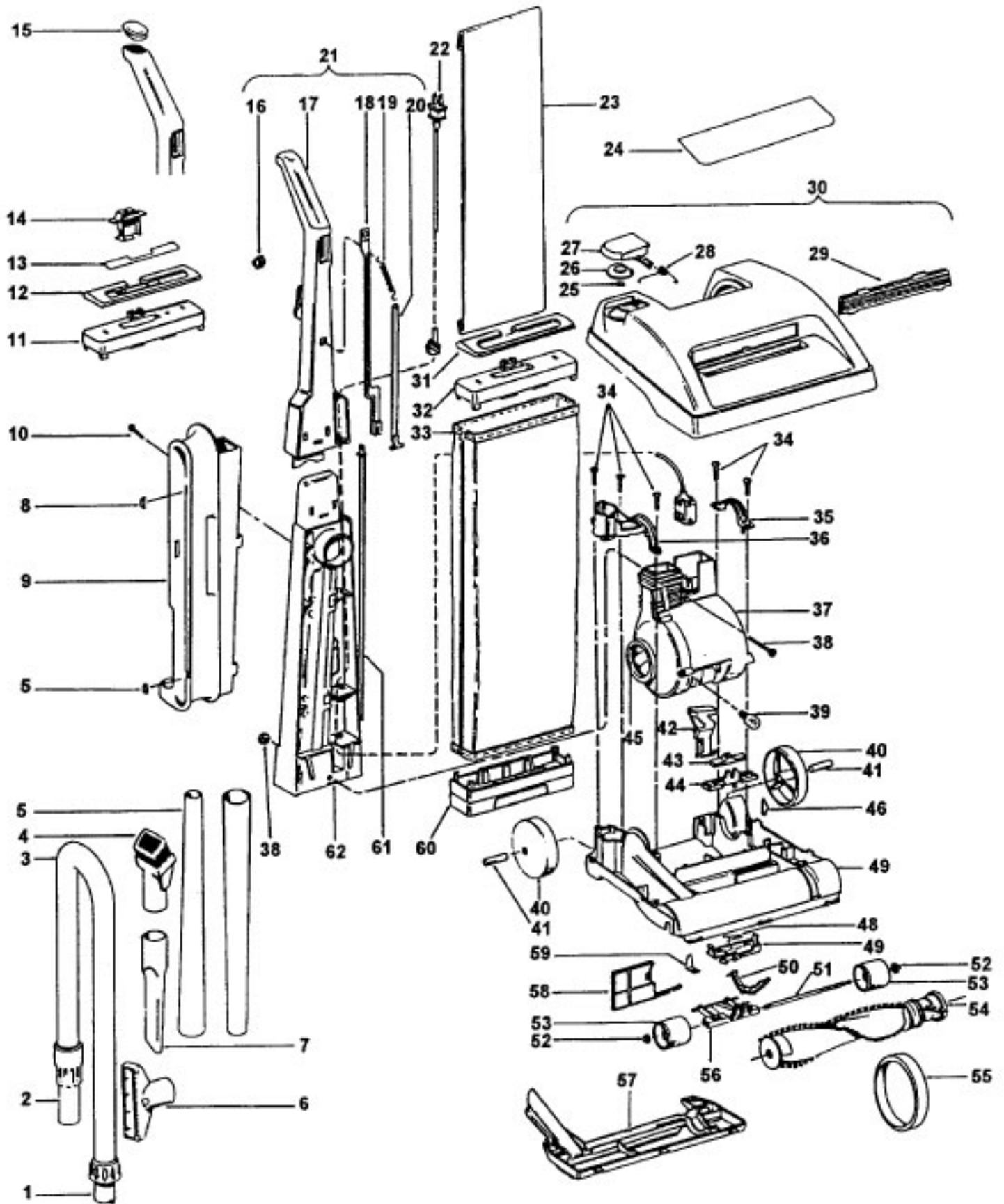

Legacy II

Models U4537-910, U4537-930, * U4537-980, U4539-930, U4551-910, U4551-920, U4563-910, U4567-910, U4567-920, U4567-930, U4585-910

Ref. No.	Part No.	Description	Ref. No.	Part No.	Description	
1	32377004	Hose Connector			U4567-910 Incl. Items 31,32,60	
2	32288011	Hose Adapter - AG		43686133	Outer Bag Comp. - U4585-910 (Incl. Items 31,32,60)	
3	43434088	Cleaning Tool Hose Assem.		43686162	Outer Bag Comp. - U4567-920 (Incl. Items 31,32,60)	
4	43414145	Dusting Brush - Friction		43686161	Outer Bag Comp. - U4551-920 (Incl. Items 31,32,60)	
5	38634078	Extension Tube		43686160	Outer Bag Comp. - U4537-910 (Incl. Items 32,60)	
6	38614029	Furniture Nozzle		43686175	Outer Bag Comp. - U4537-930 (incl. It 32,60)	
7	38617024	Crevice Tool		43686176	Outer Bag Comp. - U4567-930 (Incl. Items 31,32,60)	
8	37941042	Hinge Cap		43686221	Outer Bag Comp. - U4539-930	
9	41426087	Tool Holder/Hinge Cap		34	21447217	Screw - Self Tapping
	41426019	Tool Holder Assem. U4537-910, U4537-930, U4539-930		35	36131090	Motor Retainer Cap - L.H.
	41426089	Tool Holder/Door Assem. - U4567-920 U4567-930		36	38613029	Air Intake
10	21447220	Screw - Self Tapping		37	43576142	Motor - (P - 202)
11	38425062	Jacket Support Upper - U4585-910		38	40201085	Nut & Bolt
12	37959076	Jacket Support Cap - U4585-910		39	27313101	Dirt Finder Lamp
13	51639092	Cap Nameplate - U4585-910		40	38522011	Rear Wheel
14	35111002	Drawer - U4585-910		41	31523012	Wheel Shaft
15	37911079	Handle Cap - ABE - U4537-910, U4537-930, U4563-910		42	38458022	Handle Release Lever
16	38421003	Switch Button		43	38567014	Indicator Knob
17	39458056	Handle Grip - U4551-910, U4551-920, U4567-910, U4567-920, U4567-930, U4585-910, U4539-930		44	38567009	Cam Actuator
	39458057	Handle Grip - U4537-930 (Kohl's)		45	38784016	Seal
18	38458006	Switch Rod Upper		46	13261AY	Rug Nozzle Rib Shoe
19	38335020	Bag Strap Spring		47	42242266	Main Body (Incl. Items 40,41,42,46)
20	36425072	Bag Strap		48	38351012	Spring
21	48663164	Upper Handle Assem. - U4551-910, U4551-920, U4567-910, U4567-920, U4567-930, U4585-910, U4537-930 (Kohl's), U4539-930		49	38563013	Nozzle Height Adj. Cam
	48663165	Upper Handle Assem. - U4537-910, U4537-930, U4563-910 (w/Handle Cap - Item 15)		50	38452089	Lever (Use wheel assem. 43248059)
22	46388027	Attachment Cord - 35'		51	32563012	Wheel Shaft (Use 43248059)
23	4010001A	Disp. Bag - 3 Pk.		52	36131056	Wheel Retainer
	4010100A	Disp. Bag - 3 Pk. - Micro - U4537-910, U4537-930, U4567-920, U4567-930		53	43248059	Front Wheel
24	51669066	Hood Nameplate		54	48414081	Agitator - (P - 204)
	52115183	Hood Nameplate - U4551-910		55	38528027	Belt
	52115184	Hood Nameplate - U4563-910		56	43248059	Front Wheel Assem. (Incl. It. 50, 51, 53)
	52115188	Hood Nameplate - U4567-910		57	37245108	Bottom Plate
	52115185	Hood Nameplate - U4585-910		58	38718005	Valve Gate
	52115190	Hood Nameplate - U4537-910		59	34572002	Cam Actuator Spring
	52115189	Hood Nameplate - U4567-920		60	36425053	Jacket Support Lower
25	21362006	Speed Nut		61	38458046	Switch Rod Lower
26	38784056	Seal		62	48669001	Lower Handle/Muffler Assem.
27	42247005	Air Intake Door Assem. - AAY U4551-910, U4551-920 (Incl. Items 25,26)			48669017	Lower Handle - U4537-930 (Kohl's)
	42247003	Air Intake Door Assem. - AG - U4563-910, U4567-910, U4567-920, U4567-930 (Incl. It. 25,26)		ITEMS NOT ILLUSTRATED		
	37257175	Air Intake Door Assem. - ABB (Incl. It 25,26) U4539-930		3944201P	Cord Wrap	
	42247009	Air Intake Door Assem. - ABM U4537-910, U4537-930 (Incl. It. 25,26)		57363002	Air Freshener Tablet - 1 Pk. - U4585-910	
28	38351011	Spring		57363003	Air Freshener Tablet - 4 Pk. - U4585-910	
29	39383097	Dirt Finder Lens		56511233	Owner Manual - U4537-930, U4539-930	
30	42252229	Hood Assem. w/o Nameplate - AAY - U4551-910, U4551-920		56511397	Owner Manual - U4567-930	
	42252227	Hood Assem. w/o Nameplate - AG - U4563-910, U4567-910, U4567-920, U4567-930		56511373	Owner Manual	
	42252292	Hood Assem. w/o Nameplate - ABB - U4585-910, U4539-930		56511382	Owner Manual - U4537-910	
	42252298	Hood Assem. w/o Nameplate - ABM - U4537-910, U4537-930		58174077	Carton - U4537-980	
31	37959072	Jacket Support Cap - U4551-910, U4563-910, U4567-910, U4567-930		58185184	Carton - Common	
32	36425062	Jacket Support Upper - U4551-910, U4563-910, U4567-910, U4567-930		58366096	Front Support - U4537-980	
	36425064	Jacket Support Upper - U4537-910, U4537-930, U4539-930		58366097	Rear Support - U4537-980	
33	43686130	Outer Bag Comp. - U4551-910 (Incl. Items 31,32,60)		58385018	Cleaner Support	
	43686132	Outer Bag Comp. - U4563-910,		58385021	Cleaner Support - U4537-910, U4537-930	
				58347026	Carton	
				38347023	Cleaning Tool Carton - U4537-980	
				37257170	Tool Holder Door - U4567-920	

* Note: Model U4537-980 is an ensemble which includes the Model U4537-930 Legacy II Upright and a Model S1103 Dubl-Duty Wet/Dry Hand Cleaner. (For Model S1103 components see Hand/Stick microfiche sections page 54)

Agitator - 48414081
Agitator - 48414075

Elite/ Elite II/ Dimension/ Legacy/ TurboPOWER/ Caddy Vac - Four Brush
Caddy Vac - Four Brush

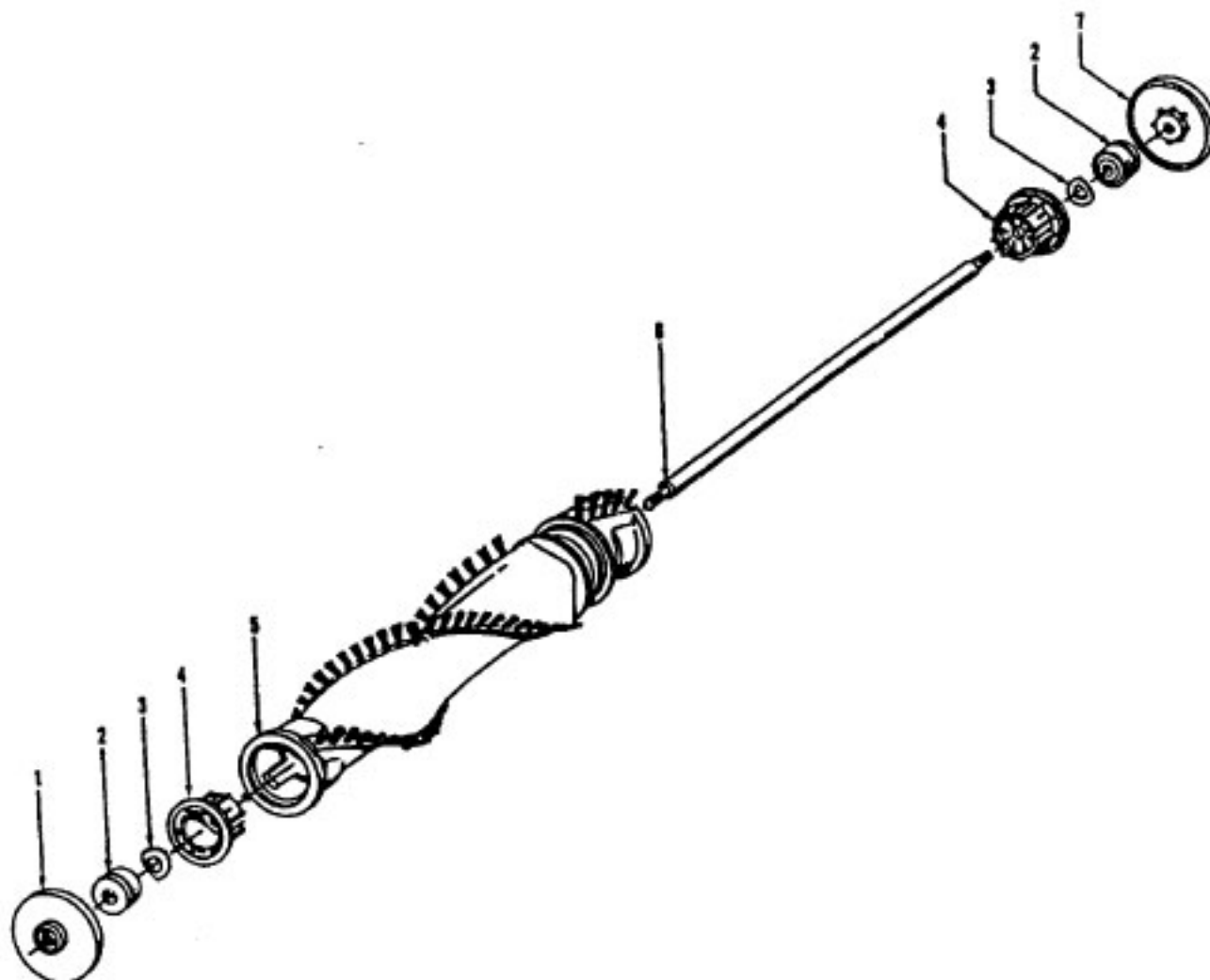

Ref. No.	Part No.	Description
	48414081	Agitator Assem. Complete (Natural Bristles)
	48414075	Agitator Assem. Complete (Blue Bristles)
1	36423016	Thread Guard - RH
2	43267002	Agitator Bearing Assem. (2)
3	21347003	Conical Washer (2)
4	36422022	Agitator End (2)
5	N/A	Agitator Body
6	32724013	Agitator Shaft
7	36423017	Thread Guard - LH - AG



Ref. No.	Part No.	Description
	43576142	Motor Assem. Comp.
	43576181	Motor Assem. Comp. (Replaced by 43576204)
1	214793DA	Screw-Self Tapping (4)
2	38736033	Fan Chamber
3	38755030	Fan
4	N/A	Rivet - Semi Tubular (2)
5	N/A	Motor Housing Assem.
6	N/A	Motor Brush Holder (2)
7	N/A	Motor Brush Assem. (2)
8	N/A	Bearing
9	N/A	Bearing Retainer
10	36914004	Switch Bus Bar
11	39116005	Attachment Terminal
12	28218043	Switch Assem. - Early Models (Prior to 5/96)
	28161062	Switch Assem. - Late Models (After 5/96)
13	N/A	Armature/Bearing Assem.
14	37194046	Motor End Cap Assem. - MW
15	N/A	Field Assem.
16	N/A	Lamp Holder Assem.
17	21312793	Washer
18	38783020	Duct Seal
19	41311016	Motor Brush Holder Assem.

ITEMS NOT ILLUSTRATED

- 38781013 Duct Seal (8 1/2" Long adhesive backed foam seal used on early models in place of item 18)
- 54821001 Tape (Roll)