

This Owner's Manual is provided and hosted by [Appliance Factory Parts](#).



Hotpoint HDA4000N10BB Owner's Manual

[Shop genuine replacement parts for Hotpoint
HDA4000N10BB](#)



[Find Your Hotpoint Dishwasher Parts - Select From 67 Models](#)

----- Manual continues below -----



Dishwashers

Safety Instructions 2, 3

Operating Instructions

Care and Cleaning 12, 13
Control Panel and Settings 4-7
Loading Place Settings 11
Loading the Racks 10
Optional Accessories 12
Using the Dishwasher 8, 9

Troubleshooting Tips .. 14, 15

Consumer Support

Consumer Support Back Cover
Warranty 17

Owner's Manual

- EDW4000 Series
- EDW5000 Series
- EDW6000 Series
- GHDA400 Series
- GHDA600 Series
- GLD4000 Series
- GLD5000 Series
- GLD6000 Series
- HLD4000 Series
- GLDE400 Series
- GLDE500 Series

Write the model and serial numbers here:

Model # _____

Serial # _____

You can find them on the tub wall just inside the door.

IMPORTANT SAFETY INFORMATION.

READ ALL INSTRUCTIONS BEFORE USING —

SAVE THESE INSTRUCTIONS

⚠ WARNING!

For your safety, the information in this manual must be followed to minimize the risk of fire or explosion, electric shock, and to prevent property damage, personal injury, or death.



⚠ WARNING! WATER HEATER SAFETY

Under certain conditions hydrogen gas may be produced in a water heater that has not been used for two weeks or more. **HYDROGEN GAS IS EXPLOSIVE.**

If the hot water has not been used for two weeks or more, prevent the possibility of damage or injury by turning on all hot water faucets and allowing them to run for several minutes. Do this before using any electrical appliance which is connected to the hot water system. This simple procedure will allow any built-up hydrogen gas to escape. Since the gas is flammable, do not smoke or use an open flame or appliance during this process.



PROPER INSTALLATION AND MAINTENANCE

This dishwasher must be properly installed and located in accordance with the Installation Instructions before it is used. If you did not receive an Installation Instructions sheet with your dishwasher, you can receive one by visiting our website at ge.com.

- Connect to a grounded metal, permanent wiring system; or run an equipment-grounding conductor with the circuit conductors and connect to the equipment-grounding terminal or lead of the appliance.
 - Improper connection of the equipment-grounding conductor can result in a risk of electric shock. Check with a qualified electrician or service representative if you are in doubt whether the appliance is properly grounded.
 - Dispose of discarded appliances and shipping or packing material properly.
 - Do not attempt to repair or replace any part of your dishwasher unless it is specifically recommended in this manual. All other servicing should be referred to a qualified technician.
 - To minimize the possibility of electric shock, disconnect this appliance from the power supply before attempting any maintenance.
- NOTE:** Turning the dishwasher off does not disconnect the appliance from the power supply. We recommend having a qualified technician service your appliance.

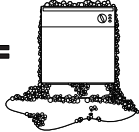
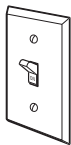

⚠ CAUTION: To prevent minor injury or property damage

- Contents washed in Anti-bacterial mode, if available, may be hot to the touch. Use care before handling.
- Using a detergent that is not specifically designed for dishwashers will cause the dishwasher to fill with suds.  = 
- If your dishwasher is connected to a wall switch, ensure that the switch is on prior to use. 
- On dishwashers with electronic controls, if you choose to turn the switch off between wash cycles, allow 5-10 seconds after turning the switch on before touching START/RESET to allow the control to reboot.
- Non-Dishware Items: Do not wash items such as electronic air cleaner filters, furnace filters and paint brushes in your dishwasher. Damage to dishwasher and discoloration or staining of dishwasher may result.
- Close supervision is necessary if this appliance is used by or near children.
- Load light, plastic items so they will not become dislodged and drop to the bottom of the dishwasher—they might come into contact with the heating element and be damaged.

⚠️ **WARNING! RISK OF CHILD ENTRAPMENT**

PROPER DISPOSAL OF THE DISHWASHER

Junked or abandoned dishwashers are dangerous...even if they will sit for "just a few days." If you are getting rid of your old dishwasher, please follow the instructions below to help prevent accidents.

Before You Throw Away Your Old Dishwasher:

- Take off the door of the washing compartment or remove the door latch keeper (as shown).

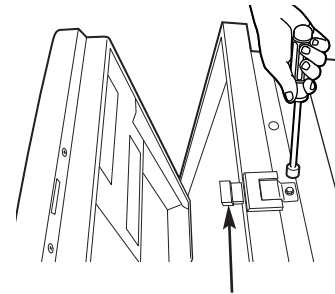

Door latch keeper

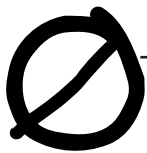

⚠️ **WARNING!**

When using your dishwasher, follow basic precautions, including the following:

- Use this appliance only for its intended purpose as described in this Owner's Manual.
- Use only powder, tabs, liquid detergents or rinse agents recommended for use in a dishwasher and keep them out of the reach of children. **Cascade®**, **Cascade® Complete** and **Electrasol®** Automatic Dishwashing Detergents, and **Jet-Dry®** and **Cascade Rinse Aid®** rinse agents have been approved for use in all GE dishwashers.
- Locate sharp items so that they are not likely to damage the door seal.
- Load sharp knives with the handles up to reduce the risk of cut-type injuries.
- Do not wash plastic items unless marked dishwasher safe or the equivalent. For plastic items not so marked, check the manufacturer's recommendations.
- Do not touch the heating element during or immediately after use.
- Do not operate your dishwasher unless all enclosure panels are properly in place.
- Do not tamper with controls.
- Do not abuse, sit on or stand on the door or dish rack of the dishwasher.
- Do not allow children to play around the dishwasher when opening or closing the door due to the possibility of small fingers being pinched in the door.
- Do not discard a dishwasher without first removing the door of the washing compartment.
- Do not store or use combustible materials, gasoline or other flammable vapors and liquids in the vicinity of this or any other appliance.
- Do not allow children to play with, on or inside this appliance or any discarded appliance.



READ AND FOLLOW THIS SAFETY INFORMATION CAREFULLY.

SAVE THESE INSTRUCTIONS

About the dishwasher control panel. (For models with sensor: EDW6000 Series, GHDA600 Series, GLD6000 Series)

You can locate your model number on the tub wall just inside the door. Throughout this manual, features and appearance may vary from your model.

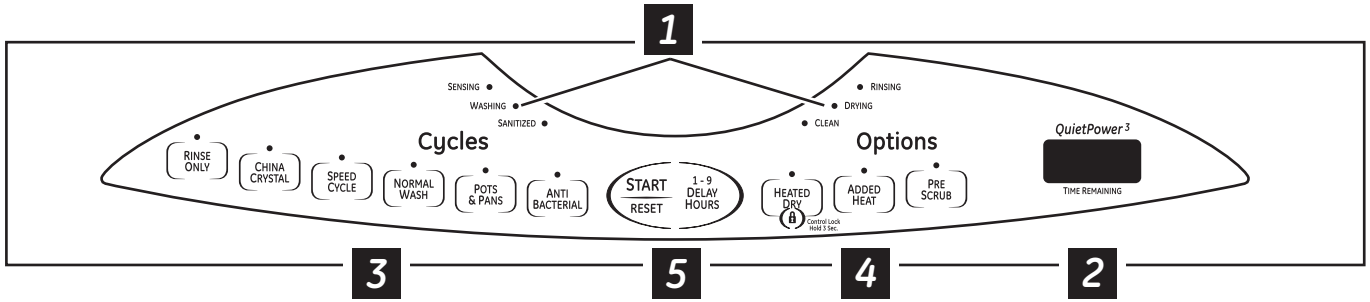

Control Settings

1 Status Indicator Lights

The Status display tells you what's happening while the dishwasher is in operation and may flash, indicating a malfunction. The lights will come **ON** indicating the sequence of operation the dishwasher is in.

SENSING (on some models)	Displayed while the sensor is measuring the amount of soil and temperature of water. The dishwasher will adjust the selected cycle to achieve optimal performance.
WASHING (on some models)	Displayed during prewash and main wash periods.
RINSING (on some models)	Displayed during rinse periods.
DRYING (on some models)	Displayed during HEATED DRY .
SANITIZED	Displayed when cycle has met sanitization conditions. Light remains ON until door is opened.
CLEAN	Displayed when a wash cycle is complete. The light stays ON as a reminder that the dishes are clean until the door is relatched or until another cycle is selected.

2 Time Remaining Display (on some models)

During operation, the display shows the minutes remaining until the cycle is complete. The display may adjust the remaining time while the sensing light is on. The time displayed at the start of each cycle may change from the factory setting as the unit customizes itself to home use. During a delay start, the display will show hours of time remaining until the cycle starts.

3 Cycles

The light above the selected pad will be **ON** to indicate which cycle has been selected.

This dishwasher is equipped with a dirt and temperature sensor. Cycle length and time will vary depending on the soil level and temperature.

ANTI-BACTERIAL or SANI WASH	Heavy 8.5 gal., 84 min.
	Medium 7.3 gal., 78 min.
	Light 6.1 gal., 75 min.
	This cycle raises the water temperature in the final rinse to sanitize your dishware. The cycle length will vary depending on the temperature of your inlet water.
	NOTE: The Anti-Bacterial cycle is monitored for sanitization requirements. If the cycle is interrupted during or after the main wash portion or if the incoming water temperature is so low that adequate water heating cannot be achieved, the sanitizing conditions may not be met. In these cases, the sanitized light will not illuminate at the end of the cycle.
	NOTE: NSF-certified residential dishwashers are not intended for licensed food establishments.
POTS & PANS	Heavy 10.9 gal., 102 min.
	Medium 8.5 gal., 78 min.
	Light 7.3 gal., 73 min.
	This cycle is meant for heavily soiled dishes or cookware with dried-on or baked-on soils. Everyday dishes are safe to be used in this cycle.
NORMAL WASH	Heavy 8.5 gal., 65 min.
	Medium 7.3 gal., 60 min.
	Light 4.9 gal., 49 min.
	This cycle is for medium/heavily soiled dishes and glassware.

SPEED CYCLE or SPEED WASH (on some models)	7.3 gal., 35 min. This cycle is for everyday dishes and glassware.
CHINA CRYSTAL (on some models)	7.3 gal., 48 min. This cycle is for lightly soiled china and crystal.
RINSE ONLY	2.5 gal., 12 min. For rinsing partial loads that will be washed later. Do not use detergent with this cycle.

NOTE: Only the Anti-Bacteria cycle has been designed to meet the requirements of Section 6, NSF 184 for soil removal and sanitization efficacy.

4 Options

The light above the selected pad will be **ON** to indicate which option has been selected.

PRE SCRUB (on some models)	For use with heavily soiled and/or dried-on, baked-on soils. This option MUST be selected PRIOR to starting the cycle. <i>This option adds 16 minutes to the cycle time.</i> NOTE: Cannot be selected with RINSE ONLY cycle.
HEATED DRY Light OFF	Shuts off the drying heat option. Dishes air dry naturally and energy is saved. For faster air dry, you can prop the door open after the CLEAN light illuminates.
HEATED DRY Light ON	Turns the heater on for fast drying. This will extend the total run time by 8 minutes for the SPEED CYCLE , 38 minutes for NORMAL and POTS/PANS and 30 minutes for all other cycles. NOTE: Cannot be selected with RINSE ONLY cycle.
LOCK 	<i>You can lock the controls to prevent any selections from being made. Or you can lock the controls after you have started a cycle.</i> <i>Children cannot accidentally start dishwasher by touching pads with this option selected.</i> To LOCK the dishwasher control , touch and hold the HEATED DRY pad for 3 seconds. The light below the HEATED DRY pad will turn on. To UNLOCK the dishwasher control , touch and hold the HEATED DRY pad for 3 seconds. The LOCK light will turn off.
ADDED HEAT	When selected, the cycle will run longer with the heating element on to improve both wash and dry performance. NOTE: Cannot be selected with RINSE ONLY cycle.
DELAY HOURS	You can delay the start of a wash cycle for up to 9 hours. Touch the DELAY HOURS pad to choose the number of hours you want to delay the start of the cycle; then touch START/RESET one time. The dishwasher will count down and start automatically at the correct time. Touching START/RESET a second time will cancel the DELAY START selection.
RESET	To change a cycle after washing starts, touch the START/RESET pad to cancel the cycle. The START/RESET light will flash while the water is pumped out if needed. This takes approximately 90 seconds. When the light stops flashing, the dishwasher can be reprogrammed and restarted.

5 Start

Close and latch the dishwasher door and select the cycle and desired enhancements. Touch the **START/RESET** pad once to begin the cycle. Water begins to fill the dishwasher, and approximately 60 seconds later the wash action begins. Touching the **START/RESET** pad a second time will cancel the cycle and cause the water to drain out. This will take approximately 2 minutes.

NOTE: The dishwasher remembers your last cycle so you don't have to reprogram each time. When the dishwasher door is fully closed, the control panel lights will display the last settings you selected.

If you don't want to change any of the settings, simply touch the **START/RESET** pad once to begin the cycle.

If the door is closed, the indicator lights will turn off if the **START/RESET** pad is not pressed within two minutes. To activate the display, open and close the door or touch any pad.

Also, if a power failure occurs, **NORMAL** and **HEATED DRY** will automatically be programmed.

About the dishwasher control panel. (For models without a sensor: EDW4000 Series, EDW5000 Series, GHDA400 Series, GLD4000 Series, GLD5000 Series, HLD4000 Series, GLDE400 Series and GLDE500 Series)

You can locate your model number on the tub wall just inside the door. Throughout this manual, features and appearance may vary from your model.

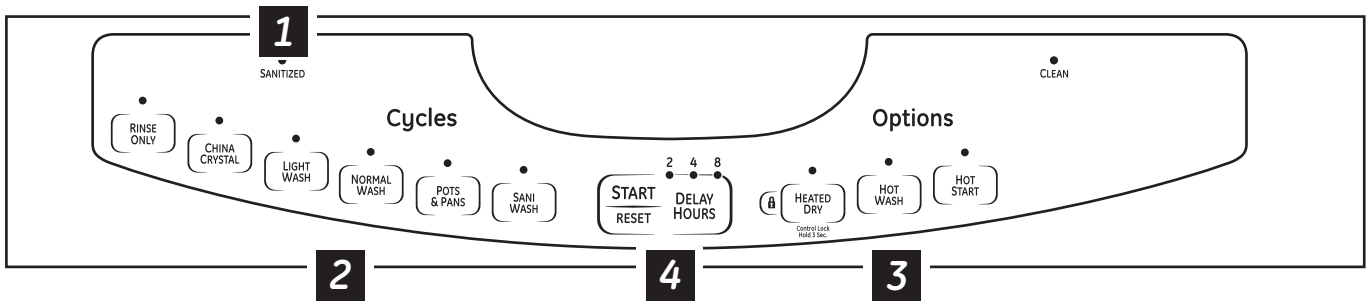

Control Settings

1 Status Indicator Lights

The Status display tells you what's happening while the dishwasher is in operation and may flash, indicating a malfunction. The lights will come **ON** indicating the sequence of operation the dishwasher is in.

SANITIZED (on some models) Displayed when cycle has met sanitization conditions. Light remains **ON** until door is opened.

CLEAN (on some models) Displayed when a wash cycle is complete. The light stays **ON** as a reminder that the dishes are clean until the door is opened or until another cycle is selected.

2 Cycles

The light above the selected pad will be **ON** to indicate which cycle has been selected.

SANI WASH (on some models) 7.3 gal., 97 min. This cycle raises the water temperature in the final rinse to sanitize your dishware. The cycle length will vary depending on the temperature of your inlet water.

NOTE: The **SANI-WASH** cycle is monitored for sanitization requirements. If the cycle is interrupted during or after the main wash portion or if the incoming water temperature is so low that adequate water heating cannot be achieved, the sanitizing conditions may not be met. In these cases, the sanitized light will not illuminate at the end of the cycle.

NOTE: NSF certified residential dishwashers are not intended for licensed food establishments.

POTS & PANS or HEAVY WASH 8.5 gal., 89 min. This cycle is meant for heavily soiled dishes or cookware with dried-on or baked-on soils. Everyday dishes are safe to be used in this cycle.

NORMAL WASH 5.9 gal., 56 min. This cycle is for medium/heavily soiled dishes and glassware.

ECO WASH (on some models) 4.8 gal., 55 min. This cycle is for everyday dishes and glassware.

LIGHT WASH (on some models) 6.1 gal., 36 min. This cycle is for everyday dishes and glassware.

CHINA CRYSTAL (on some models) 6.1 gal., 39 min. This cycle is for lightly soiled china and crystal.

RINSE ONLY 1.2 gal., 6 min. For rinsing partial loads that will be washed later. Do not use detergent with this cycle.

NOTE: Only the **SANI-WASH** cycle has been designed to meet the requirements of Section 6, NSF 184 for soil removal and sanitization efficacy.

3 Options

The light above the selected pad will be **ON** to indicate which **OPTION** has been selected.

HOT START (on some models)	For use with heavily soiled and/or dried-on, baked-on soils. This option MUST be selected PRIOR to starting the cycle. <i>This option will improve both wash and dry performance. This option adds 20 minutes to the cycle time.</i> NOTE: Cannot be selected with RINSE ONLY cycle.
HEATED DRY Light OFF	Shuts off the drying heat option. Dishes air dry naturally and energy is saved. For faster air dry you can prop the door open after the CLEAN light illuminates.
HEATED DRY Light ON	Turns the heater on for fast drying. This will extend the total run time by 38 minutes. NOTE: Cannot be selected with RINSE ONLY cycle.
LOCK  (on some models)	<i>You can lock the controls to prevent any selections from being made. Or you can lock the controls after you have started a cycle.</i> <i>Children cannot accidentally start dishwasher by touching pads with this option selected.</i> To LOCK the dishwasher control , touch and hold the HEATED DRY pad for 3 seconds. The light below the HEATED DRY pad will turn on. To UNLOCK the dishwasher control , touch and hold the HEATED DRY pad for 3 seconds. The LOCK light will turn off.
HOT WASH	When selected, the cycle will run longer with the heating element on to improve both wash and dry performance. NOTE: Cannot be selected with RINSE ONLY cycle.
DELAY HOURS	You can delay the start of a wash cycle for 2, 4 or 8 hours (delay time options may vary by model). Touch the DELAY HOURS pad to choose the number of hours you want to delay the start of the cycle; then touch START/RESET one time. The dishwasher will count down and start automatically at the correct time. Touching START/RESET a second time will cancel the DELAY START selection.
RESET	To change a cycle after washing starts, touch the START/RESET pad to cancel the cycle. The START/RESET light will flash while the water is pumped out if needed. This takes approximately 90 seconds. When the light stops flashing, the dishwasher can be reprogrammed and restarted.

4 Start

Close and latch the dishwasher door and select the cycle and desired enhancements. Touch the **START/RESET** pad once to begin the cycle. Water begins to fill the dishwasher, and approximately 60 seconds later the wash action begins. Touching the **START/RESET** pad a second time will cancel the cycle and cause the water to drain out. This will take approximately 2 minutes.

NOTE: The dishwasher remembers your last cycle so you don't have to reprogram each time. When the dishwasher door is fully closed, the control panel lights will display the last settings you selected.

If you don't want to change any of the settings, simply touch the **START/RESET** pad once to begin the cycle.

If the door is closed, the indicator lights will turn off if the **START/RESET** pad is not pressed within two minutes. To activate the display, open and close the door or touch any pad.

Also, if a power failure occurs, **NORMAL** and **HEATED DRY** will automatically be programmed.

Using the dishwasher.



Check the Water Temperature

The entering water should be at least 120°F and not more than 150°F for effective cleaning and to prevent dish damage. Check the water temperature with a candy or meat thermometer.

Turn on the hot water faucet nearest the dishwasher, place the thermometer in a glass and let the water run continuously into the glass until the temperature stops rising.



Use Jet-Dry® or Cascade Crystal Clear® Rinse Agent

Jet-Dry® or **Cascade Crystal Clear®** rinse agents remove spots and prevent new film buildup on your dishes, glasses, flatware, cookware and plastic.

Filling the Dispenser

The rinse agent dispenser holds 100 ml (3.5 fl. oz.) of rinse agent. Under normal conditions, this will last approximately one month. Try to keep it full, but do not overfill.

- 1 Make sure the dishwasher door is fully open.
- 2 Turn the dispenser cap to the left and lift it out.
- 3 Add rinse agent until the indicator window looks full.
- 4 Clean up any spilled rinse agent with a damp cloth.
- 5 Replace the dispenser cap.

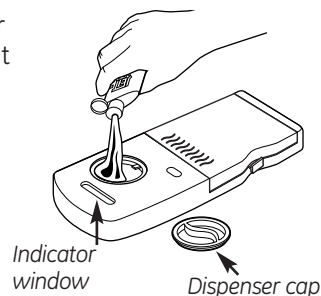

Rinse Aid Setting

The amount of rinse agent released into the final wash can be adjusted. The factory setting is at the midpoint. If there are rings of calcium (hard water) spots on dishes, try a higher setting. If you see foam in the dishwasher, move the indicator to a lower setting.

To adjust the setting

Remove the dispenser cap; then turn the adjuster counterclockwise to increase the amount of rinse agent, clockwise to reduce the amount of rinse agent.

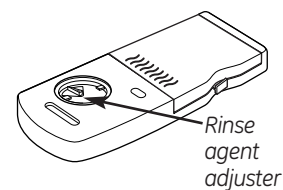

Dish Preparation Prior to Loading

- No pre-rinsing of normal food soil is required.
- Remove leafy vegetables, meat trimmings and excessive amounts of grease or oil.
- Scrape off hard soils, including bones, toothpicks, skins and seeds.
- Remove acidic food soils that can discolor stainless steel.
- Remove large quantities of any remaining food.

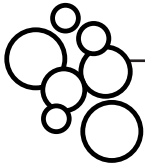

Proper Use of Detergent

Use only detergent specifically made for use in dishwashers. **Cascade®** and **Electrasol®** Automatic Dishwashing Detergents have been approved for use in all GE dishwashers. Keep your detergent fresh and dry. Don't put powder detergent into the dispenser until you're ready to wash dishes.

The amount of detergent to use depends on whether your water is *hard* or *soft*. With hard water, you need extra detergent. With soft water, you need less detergent.

Protect your dishes and dishwasher by contacting your water department and asking how hard your water is. Twelve or more grains is extremely hard water. A water softener is recommended. Without it, lime can build up in the water valve, which could stick while open and cause flooding. Too much detergent with soft water can cause a permanent cloudiness of glassware called *etching*.

Use the information in the table below as a guideline to determine the amount of automatic dishwasher detergent to place in the dispenser.

Number of Grains	Detergent Cups to Fill
Less than 4	Fill cup to first line
4 to 8	Fill cup to second line
8 to 12	Fill main wash cup
Greater than 12	Fill both Main Wash and Pre Wash cup

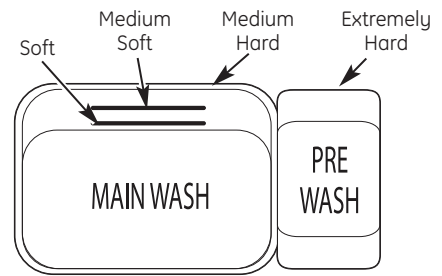

For heavily-soiled loads, use the Pots and Pans or Heavy Wash cycle and add a little extra detergent.

DO NOT USE HAND DISH DETERGENT

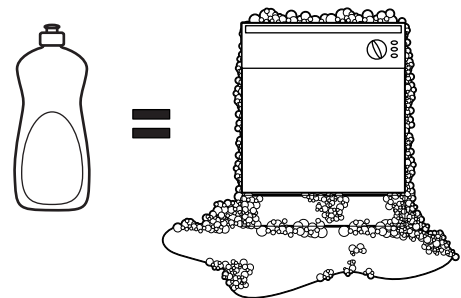

NOTE: Using a detergent that is not specifically designed for dishwashers will cause the dishwasher to fill with suds. During operation, these suds will spill out of the dishwasher vents, covering the kitchen floor and making the floor wet.

Because so many detergent containers look alike, store the dishwasher detergent in a separate space from all other cleaners. Show anyone who may use the dishwasher the correct detergent and where it is stored.

While there will be no lasting damage to the dishwasher, your dishes will not get clean using a dishwashing detergent that is not formulated to work with dishwashers.



Forget to Add a Dish?

A forgotten dish can be added any time before the main wash.

- 1 Squeeze the door latch to release the door.
- 2 Do not open the door until the water spray action stops. Steam may rise out of the dishwasher.

- 3 Add forgotten dishes.
- 4 Close the door.

Loading the dishwasher racks.

For best dishwashing results, follow these loading guidelines. Features and appearance of racks and silverware baskets may vary from your model.

Upper Rack

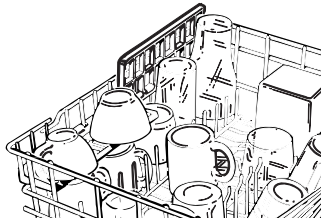

Although the upper rack is for glasses, cups and saucers, pots and pans can be placed in this rack for effective cleaning. Cups and glasses fit best along the sides. This is also a secure place for dishwasher-safe plastics.

The utility shelf (on some models) may be placed in the up or down position to add flexibility. A wine glass holder (on some models) secures wine glasses for best washability. Because wine glasses come in various sizes, after loading, slowly push in the rack to make sure they will clear the top of the dishwasher.

The upper rack is good for all kinds of odd-shaped utensils. Saucepans, mixing bowls and other items should be placed face down. Fold-down tines (on some models) provide flexibility for extra-large and hard-to-fit items.

Secure larger dishwasher-safe plastics over 2 times when possible.

Make sure small plastic items are secure so they can't fall onto the heater.

Be sure that items do not protrude through the bottom of the rack and block rotation of the middle spray arm. This could result in poor wash performance for items in the upper rack.

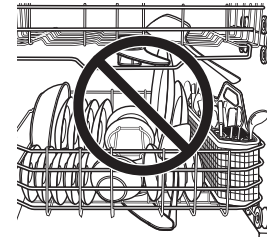

Check to make sure that no items will block rotation of the wash arms.

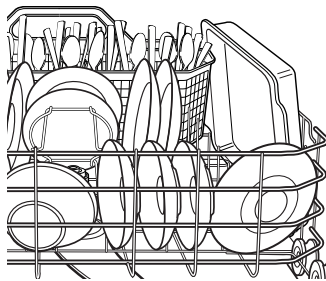
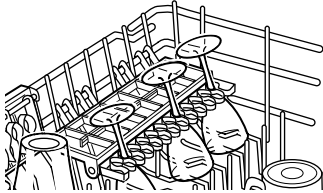

Lower Rack

The lower rack is best used for plates, saucers and cookware. Large items such as broiler pans and baking racks should go along the left-hand side. Load platters, pots and bowls along the sides, in corners or in the back. The soiled side of items should face the center of the rack. If necessary, oversized glasses and mugs can be placed in the lower rack to maximize loading flexibility.

Also, be careful not to let a portion of an item such as a pot or dish handle extend through the bottom rack. This could block the wash arm and cause poor washing results.

Fold-down tines (on some models) provide flexibility for extra-large and hard-to-fit items. The tines may be left in the up position or folded down to customize the lower rack.



Do not let any item extend through the bottom of the silverware basket. Items that extend through the rack could prevent the spray arm from turning and cause poor wash performance.

Single basket (on some models)



One-piece basket (on some models)



Two-piece basket (on some models)



Modular basket (on some models)

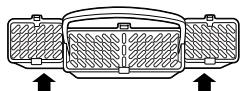

To remove end baskets, grasp the basket at opposite corners and slide apart.

Silverware Basket

To load flatware, simply push the adjustable handle to either side (on some models). Put flatware in the removable basket with fork and knife handles up to protect your hands. Place spoons in the basket with handles down. Mix knives, forks and spoons so they don't nest together. Distribute evenly. Small plastic items, such as measuring spoons and lids from small containers, should go in the bottom of the silverware basket with the silverware on top.

The one-piece silverware basket (on some models) can be placed in the front, right side or back of the lower rack.

A variety of options are available regarding the modular silverware basket (on some models). The complete basket is designed to fit on the right side of the lower rack. Additionally, the ends of the basket are removable to add loading flexibility to accommodate flatware and lower rack capacity needs.

The lids of both end and middle baskets (on some models) can be closed to contain small items. Long items can be placed on the utility shelf in the upper rack.

The accessory basket (on some models) can hold small items such as: baby bottle nipples, plastic lids, corn cob holders, etc.

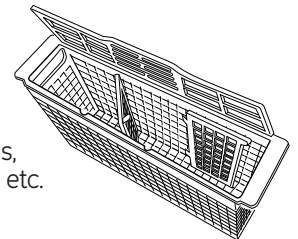

Loading place settings.

ge.com

Follow these guidelines for loading 10 place settings. Features and appearance of racks and silverware baskets may vary from your model.

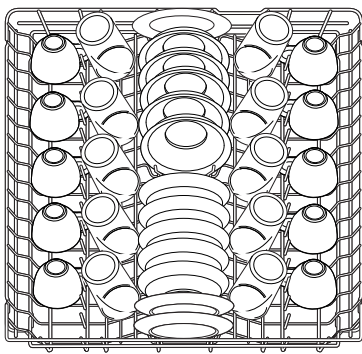

Upper Rack—10 place settings

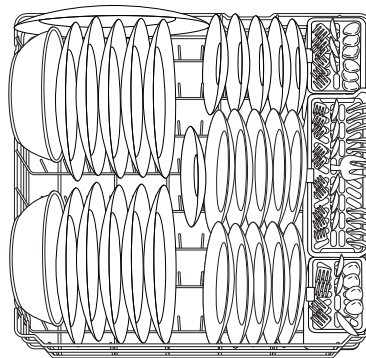

Lower Rack—10 place settings

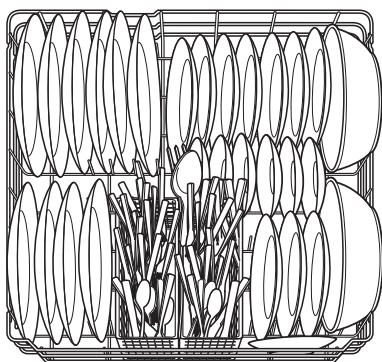

Lower Rack—10 place settings

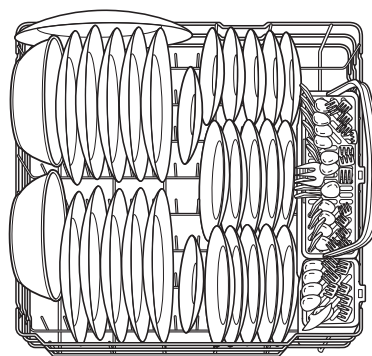

Lower Rack—10 place settings

Follow these guidelines for loading 12 place settings. Features and appearance of racks and silverware baskets may vary from your model.

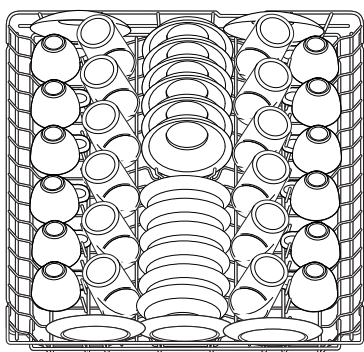

Upper Rack—12 place settings

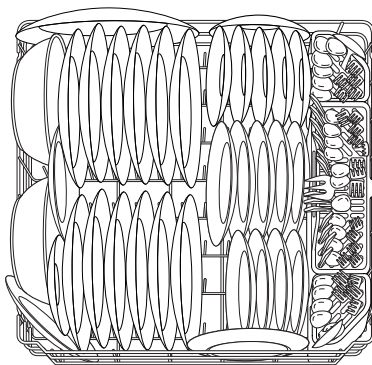

Lower Rack—12 place settings

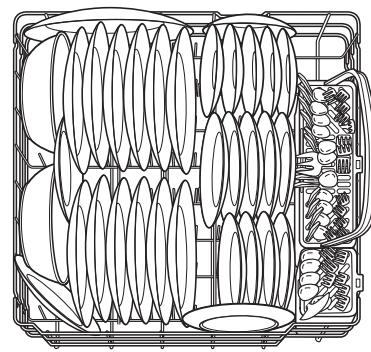

Lower Rack—12 place settings

Optional accessories.

You can change the appearance of your dishwasher by adding a custom panel trim kit.

Wood panel trim kit—This accessory contains *trim and instructions* for you to supply and install a 1/4" -thick decorative wood door:

- GPF525B (Black)
- GPF525W (White)
- GPF525C (Bisque)

Trimless wood panel kit—This accessory contains *parts and instructions* for you to supply and install a 3/4" -thick decorative wood door:

- GPF575

Non-wood countertop bracket kit—This is for installations which have non-wood countertops and includes side-mounting brackets and instructions for securing the dishwasher.

- GPF65

These accessories are available at extra cost from GE. Call 800.626.2002 to order. Visa, Mastercard or Discover cards are accepted.

Specify accessory number when ordering.

Caring for the dishwasher.

Cleaning the Door Panel

Before cleaning the front panel, make sure you know what type of panel you have. Refer to the last two letters of your model number. You can locate your model number on the left-hand tub wall just inside the door. If your model number ends with BB, WW, CC, SA, BG or GS, then you have a Painted Door panel. If your model number ends with SS, then you have a Stainless Steel Door panel. If your model number ends with CS, then you have a CleanSteel Door panel.

Follow the instructions below for cleaning the door panel for your specific model.

Painted Door Panel (model numbers ending in BB–black, WW–white, CC–bisque, SA–silver metallic, BG–graphite metallic or GS–silver)

Use a clean, soft, lightly dampened cloth, then dry thoroughly. You may also use a good appliance wax or polish.

Stainless Steel Door Panel (model numbers ending in SS)

The stainless steel panels can be cleaned with *Stainless Steel Magic* or a similar product using a clean, soft cloth. Do not use appliance wax, polish, bleach or products containing chlorine on stainless steel doors.

You can order *Stainless Steel Magic* #WX10X15 through GE Parts by calling 800.626.2002.

CleanSteel Door Panel (model numbers ending in CS)

Use a clean, soft, lightly dampened cloth, then dry thoroughly. Do not use appliance wax, polish or any chemical agent on CleanSteel doors.

Do not wipe the dishwasher with a soiled dish cloth or wet towel. These may leave a residue. Do not use scouring pads or powdered cleaners because these products can scratch the finish.

Cleaning the Control Panel

To clean the control panel, use a lightly dampened cloth. Then dry thoroughly.

Protect Against Freezing

If your dishwasher is left in an unheated place during the winter, ask a service technician to:

- 1 Cut off electrical power to the dishwasher. Remove fuses or trip circuit breaker.
- 2 Turn off the water supply and disconnect the water inlet line from the water valve.
- 3 Drain water from the water inlet line and water valve. (Use a pan to catch the water.)
- 4 Reconnect the water inlet line to the water valve.

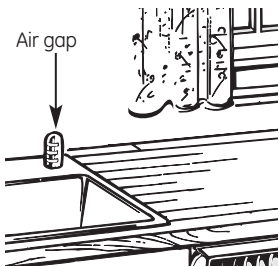

Does Your Dishwasher Have an Air Gap?

An air gap protects your dishwasher against water backing up into it if a drain clogs. The air gap is not a part of the dishwasher. It is not covered by your warranty. Not all plumbing codes require air gaps, so you may not have one.

The air gap is easy to clean.

- 1 Turn off the dishwasher and lift off the cover.
- 2 Remove the plastic cap and clean with a toothpick.

Check the air gap any time your dishwasher isn't draining well.

Before you call for service...



Troubleshooting Tips

Save time and money! Review the charts on the following pages, or visit ge.com. You may not need to call for service.

Error Messages	Possible Causes	What To Do
START/RESET status indicator light flashing	You have pressed the START/RESET pad while the dishwasher is running. This will cancel the cycle. The light will stop flashing after the dishwasher drains (about 90 seconds).	<ul style="list-style-type: none"> Press the START/RESET pad only when you want to restart the dishwasher.
Dishwasher BEEPS once every 30 seconds	This is a reminder that your dishwasher door has been left open during operation. It will continue beeping until you close the door.	<ul style="list-style-type: none"> Close and latch the door after opening it mid-cycle.

Problem	Possible Causes	What To Do
Dishes and flatware not clean	Low inlet water temperature	<ul style="list-style-type: none"> Make sure inlet water temperature is correct (see page 8). Turn on the hot water faucet nearest the dishwasher. Let run until the water temperature stops rising. Then start the dishwasher and turn off the faucet. This insures the entering water is hot.
	Water pressure is temporarily low	<ul style="list-style-type: none"> Turn on a faucet. Is water coming out more slowly than usual? If so, wait until pressure is normal before using your dishwasher.
	Air gap or disposer is clogged	<ul style="list-style-type: none"> Clean the air gap or flush the disposer.
	Improper rack loading	<ul style="list-style-type: none"> Make sure large dishware does not block the detergent dispenser or the wash arms. See the <i>Loading the dishwasher racks</i> section.
	No air gap or high drain loop	<ul style="list-style-type: none"> Verify that you have an air gap or a high drain loop. Refer to the Installation Instructions.

Spots and filming on glasses and flatware	Extremely hard water Low inlet water temperature Overloading the dishwasher Improper loading Old or damp powder detergent Rinse agent dispenser empty Too little detergent	<ul style="list-style-type: none"> Use Jet-Dry® or Cascade Crystal Clear® rinse agents to remove spots and prevent new film buildup. To remove stubborn spots and pre-existing film from glassware: <ol style="list-style-type: none"> Remove all metal utensils from the dishwasher. Do not add detergent. Select the POTS & PANS or HEAVY WASH cycle. Start the dishwasher and allow to run for 18 to 22 minutes. Dishwasher will now be in the main wash. Open the door and pour 2 cups (500 ml) of white vinegar into the bottom of the dishwasher. Close the door and allow to complete the cycle. If vinegar rinse doesn't work: Repeat as above, except use 1/4 cup (60 ml) of citric acid crystals instead of vinegar.
--	--	---

Cloudiness on glassware	Combination of soft water and too much detergent	<ul style="list-style-type: none"> This is called <i>etching</i> and is permanent. To prevent this from happening, use less detergent if you have soft water. Wash glassware in the shortest cycle that will get them clean.
	Water temperature entering the dishwasher exceeds 150°F	<ul style="list-style-type: none"> This could be etching. Lower the water heater temperature.
Suds in the tub	Wrong detergent	<ul style="list-style-type: none"> Use only automatic dishwasher detergents to avoid sudsing. Cascade® and Electrasol® Automatic Dishwashing Detergents have been approved for use in all GE dishwashers. To remove suds from the tub, open the dishwasher and let suds dissipate. Close and latch the dishwasher. Pump out water by touching the START/RESET pad once; then 30 seconds later, touch the START/RESET pad again. Repeat if necessary.
		Rinse agent was spilled

Problem	Possible Causes	What To Do
Detergent left in dispenser cups	Dishes are blocking the detergent cup	<ul style="list-style-type: none"> • Reposition the dishes so the water from the lower spray arm can flush the detergent cup. See the <i>Loading the dishwasher</i> section.
Black or gray marks on dishes	Aluminum utensils have rubbed against dishes	<ul style="list-style-type: none"> • Remove marks with a mild, abrasive cleaner.
Dishes don't dry	Low inlet water temperature	<ul style="list-style-type: none"> • Make sure inlet water temperature is at least 120°F. • Select HEATED DRY. • Use HOT START, HOT WASH or ADDED HEAT options. • Select a higher cycle, such as ANTI-BACTERIA, SANI WASH, POTS & PANS or HEAVY WASH.
	Rinse agent dispenser is empty	<ul style="list-style-type: none"> • Check the rinse agent dispenser and fill as required.
Control panel responded to inputs but dishwasher never filled with water	Door latch may not be properly seated	<ul style="list-style-type: none"> • Make sure the door is firmly closed.
	Water valve may be turned off	<ul style="list-style-type: none"> • Make sure water valve (usually located under the sink) is turned on.
Stained tub interior	Some tomato-based foods can cause reddish stains	<ul style="list-style-type: none"> • Use of the RINSE ONLY cycle after adding the dish to the load can decrease the level of staining. GE recommends Cascade® Plastic Booster to help remove these types of stains.
	Tea or coffee stains	<ul style="list-style-type: none"> • Remove the stain by hand, using a solution of 1/2 cup bleach and 3 cups warm water. <p>⚠ WARNING Before cleaning interior, wait at least 20 minutes after a cycle for the heating elements to cool down. Failure to do so can result in burns.</p>
	An overall yellow or brown film can be caused by iron deposits in water	<ul style="list-style-type: none"> • A special filter in the water supply line is the only way to correct this problem. Contact a water softener company.
	White film on inside surface—hard water minerals	<ul style="list-style-type: none"> • GE recommends Jet-Dry® or Cascade Crystal Clear® to help prevent hard water mineral deposits from forming. • Run dishwasher with citric acid to remove mineral deposits. Citric acid (Part number: WD35X151) can be ordered through GE Parts. See back cover for ordering information.
Dishwasher won't run	Fuse is blown or circuit breaker is tripped	<ul style="list-style-type: none"> • Replace fuse or reset circuit breaker. Remove any other appliances from the circuit.
	Power is turned off	<ul style="list-style-type: none"> • In some installations, the power to the dishwasher is provided through a wall switch, often located next to the disposer switch. Make sure it is on.
	Control panel is locked	<ul style="list-style-type: none"> • Unlock control panel. See page 5.
	Reboot your control	<ul style="list-style-type: none"> • Turn off power to the dishwasher (circuit breaker or wall switch) for 30 seconds; then turn back on.
Control panel lights go off when you're setting controls	Time too long between touching of selected pads	<ul style="list-style-type: none"> • Each pad must be touched within 30 seconds of the others. To relight, touch any pad again, or unlock and relatch door.
Water standing in the bottom of the tub	This is normal	<ul style="list-style-type: none"> • A small amount of clean water around the outlet on the tub bottom at the back of the tub keeps the water seal lubricated.
Water won't pump out of the tub	Drain is clogged	<ul style="list-style-type: none"> • If you have an air gap, clean it. See page 13. • If the dishwasher drains into a disposer, run disposer clear. • Check to see if your kitchen sink is draining well. If not, you may need a plumber.
Steam	This is normal	<ul style="list-style-type: none"> • Warm, moist air comes through the vent by the door latch during drying and when water is being pumped out. This is necessary for drying.
Sanitized light does not illuminate at the end of the cycle (Anti-Bacteria cycle only)	The door was opened and the cycle was interrupted during or after the main wash portion	<ul style="list-style-type: none"> • Do not interrupt the cycle anytime during or after main wash.
	The incoming water temperature was too low	<ul style="list-style-type: none"> • Raise the water heater temperature to between 120°F and 140°F.
Noise	Normal operating sounds	<ul style="list-style-type: none"> • Detergent cup opening. • Water entering dishwasher. • The motor stops and starts at various times during the cycle. • Drain pump sounds during the pump out.
	Rattling dishes when the spray arm rotates	<ul style="list-style-type: none"> • Make sure dishes are properly loaded. See the <i>Loading the dishwasher racks</i> section.

Consumer Support

Troubleshooting Tips

Operating Instructions

Safety Instructions

Notes.

GE Dishwasher Warranty.



All warranty service provided by our Factory Service Centers, or an authorized Customer Care® technician. To schedule service on-line, visit us at ge.com, or call 800.GE.CARES (800.432.2737). Please have serial number and model number available when calling for service.

Staple your receipt here.
Proof of the original purchase date is needed to obtain service under the warranty.

For The Period Of: GE Will Replace:

One Year

From the date of the original purchase

Any part of the dishwasher which fails due to a defect in materials or workmanship. During this **limited one-year warranty**, GE will also provide, **free of charge**, all labor and related service to replace the defective part.

What GE Will Not Cover:

- Service trips to your home to teach you how to use the product.
- Improper installation, delivery or maintenance.
- Failure of the product if it is abused, misused, or used for other than the intended purpose or used commercially.
- Replacement of house fuses or resetting of circuit breakers.
- Damage to the product caused by accident, fire, floods or acts of God.
- Incidental or consequential damage caused by possible defects with this appliance.
- Cleaning or servicing of the air gap device in the drain line.
- Damage caused after delivery.
- Product not accessible to provide required service.

EXCLUSION OF IMPLIED WARRANTIES—Your sole and exclusive remedy is product repair as provided in this Limited Warranty. Any implied warranties, including the implied warranties of merchantability or fitness for a particular purpose, are limited to one year or the shortest period allowed by law.

This warranty is extended to the original purchaser and any succeeding owner for products purchased for home use within the USA. If the product is located in an area where service by a GE Authorized Servicer is not available, you may be responsible for a trip charge or you may be required to bring the product to an Authorized GE Service location for service. Proof of original purchase date is needed to obtain service under the warranty. In Alaska, the warranty excludes the cost of shipping or service calls to your home.

Some states do not allow the exclusion or limitation of incidental or consequential damages. This warranty gives you specific legal rights, and you may also have other rights which vary from state to state. To know what your legal rights are, consult your local or state consumer affairs office or your state's Attorney General.

Warrantor: General Electric Company. Louisville, KY 40225

Consumer Support.



GE Appliances Website

ge.com

Have a question or need assistance with your appliance? Try the GE Appliances Website 24 hours a day, any day of the year! For greater convenience and faster service, you can now download Owner's Manuals, order parts or even schedule service on-line.



Schedule Service

ge.com

Expert GE repair service is only one step away from your door. Get on-line and schedule your service at your convenience any day of the year! Or call 800.GE.CARES (800.432.2737) during normal business hours.



Real Life Design Studio

ge.com

GE supports the Universal Design concept—products, services and environments that can be used by people of all ages, sizes and capabilities. We recognize the need to design for a wide range of physical and mental abilities and impairments. For details of GE's Universal Design applications, including kitchen design ideas for people with disabilities, check out our Website today. For the hearing impaired, please call 800.TDD.GEAC (800.833.4322).



Extended Warranties

ge.com

Purchase a GE extended warranty and learn about special discounts that are available while your warranty is still in effect. You can purchase it on-line anytime, or call 800.626.2224 during normal business hours. GE Consumer Home Services will still be there after your warranty expires.

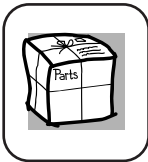

Parts and Accessories

ge.com

Individuals qualified to service their own appliances can have parts or accessories sent directly to their homes (VISA, MasterCard and Discover cards are accepted). Order on-line today, 24 hours every day or by phone at 800.626.2002 during normal business hours.

Instructions contained in this manual cover procedures to be performed by any user. Other servicing generally should be referred to qualified service personnel. Caution must be exercised, since improper servicing may cause unsafe operation.



Contact Us

ge.com

If you are not satisfied with the service you receive from GE, contact us on our Website with all the details including your phone number, or write to:
General Manager, Customer Relations
GE Appliances, Appliance Park
Louisville, KY 40225



Register Your Appliance

ge.com

Register your new appliance on-line—at your convenience! Timely product registration will allow for enhanced communication and prompt service under the terms of your warranty, should the need arise. You may also mail in the pre-printed registration card included in the packing material, or detach and use the form in this Owner's Manual.