

This Owner's Manual is provided and hosted by [Appliance Factory Parts](http://www.appliancefactoryparts.com).

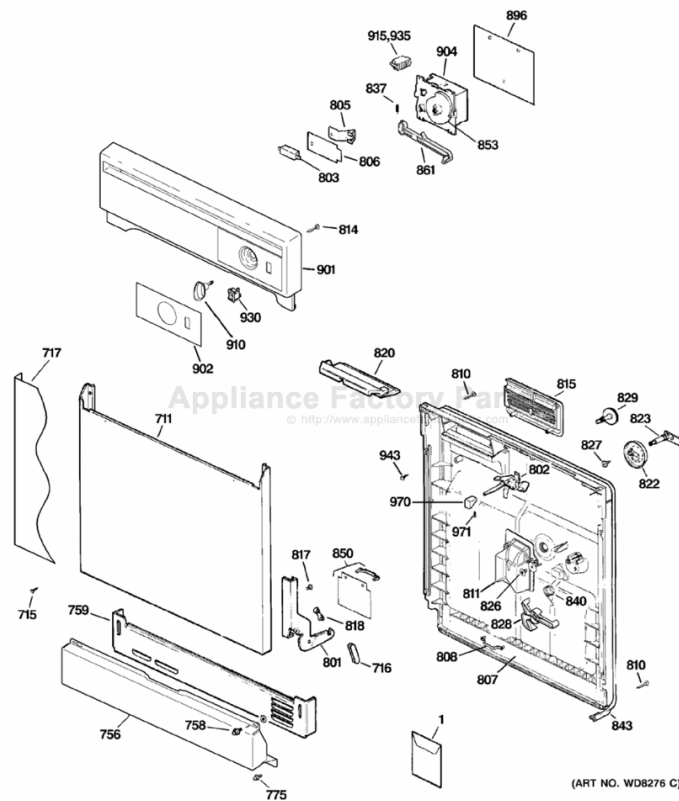

GE ADW1100N10WW Owner's Manual

[Shop genuine replacement parts for GE
ADW1100N10WW](#)



[Find Your GE Dishwasher Parts - Select From 6722 Models](#)

----- Manual continues below -----



Dishwashers

Safety Instructions 2, 3

Operating Instructions

Care and Cleaning12

Control Panels6

Control Settings 4-5

Dial Cycles7

Flashing Display Lights 8

Loading the

Dishwasher Racks10

Loading Place Settings11

Optional Accessories12

Using the Dishwasher 8, 9

Troubleshooting Tips ... 13, 14

Consumer Support

Consumer Support Back Cover

Warranty 15

Owner's Manual

ADW1000 Series

GHDA300 Series

GSD1000 Series

GSD2000 Series

GSD3000 Series

GSD4000 Series

GSM2000 Series

HDA1000 Series

HDA2000 Series

HDA3000 Series

Write the model and serial numbers here:

Model # _____

Serial # _____

You can find them on a label on the tub wall just inside the door.



IMPORTANT SAFETY INFORMATION

READ ALL INSTRUCTIONS BEFORE USING —

SAVE THESE INSTRUCTIONS

⚠ WARNING!

For your safety, the information in this manual must be followed to minimize the risk of fire, explosion, electric shock, and to prevent property damage, personal injury, or death.



⚠ WARNING! WATER HEATER SAFETY

Under certain conditions, hydrogen gas may be produced in a water heater that has not been used for two or more weeks. **HYDROGEN GAS IS EXPLOSIVE.**

If the hot water has not been used for two or more weeks, prevent the possibility of damage or injury by turning on all hot water faucets and allow them to run for several minutes. Do this before using any electrical appliance connected to the hot water system. This simple procedure will allow any built-up hydrogen gas to escape. Since the gas is flammable, do not smoke, use an open flame, or use the appliance during this process.



PROPER INSTALLATION AND MAINTENANCE

This dishwasher must be properly installed and located in accordance with the Installation Instructions before it is used. If you did not receive an Installation Instructions sheet with your dishwasher, you can receive one by visiting our website at ge.com.

- Connect the dishwasher/appliance to a grounded metal, permanent wiring system; or run an equipment-grounding conductor with the circuit conductors and connect to the equipment-grounding terminal or lead of the appliance.
 - Improper connection of the equipment-grounding conductor can result in a risk of electric shock. Check with a qualified electrician or service representative if you are in doubt whether the appliance is properly grounded.
 - Dispose of discarded appliances and shipping or packing material properly.
 - Do not attempt to repair or replace any part of your dishwasher unless it is specifically recommended in this manual. All other servicing should be referred to a qualified technician.
 - To minimize the possibility of electric shock, disconnect this appliance from the power supply before attempting any maintenance.
- NOTE:** Turning the dishwasher off does not disconnect the appliance from the power supply. We recommend having a qualified technician service your appliance.

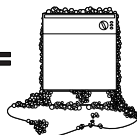
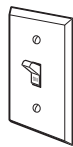

⚠ CAUTION: To prevent minor injury and property damage

- Contents washed in Anti-bacterial mode, if available, may be hot to the touch. Use care before handling.
- Using a detergent that is not specifically designed for dishwashers will cause the dishwasher to fill with suds.  = 
- If your dishwasher is connected to a wall switch, ensure that the switch is on prior to use. 
- On dishwashers with electronic controls, if you choose to turn the wall switch off between wash cycles, allow 5-10 seconds after turning the switch on before touching START/RESET to allow the control to initialize.
- Non-Dishware Items: Do not wash items such as electronic air cleaner filters, furnace filters and paint brushes in your dishwasher. Damage to the dishwasher and discoloration or staining of the dishwasher may result.
- Close supervision is necessary if this appliance is used by or near children.
- Load light, plastic items so they do not become dislodged and drop to the bottom of the dishwasher—they might come into contact with the heating element and be damaged.

⚠ WARNING! RISK OF CHILD ENTRAPMENT

PROPER DISPOSAL OF THE DISHWASHER

Junked or abandoned dishwashers are dangerous...even if they will sit for "just a few days." If you are getting rid of your old dishwasher, please follow the instructions below to help prevent accidents.

Before You Throw Away Your Old Dishwasher:

- Take off the door of the washing compartment or remove the door latch keeper (as shown).

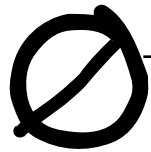
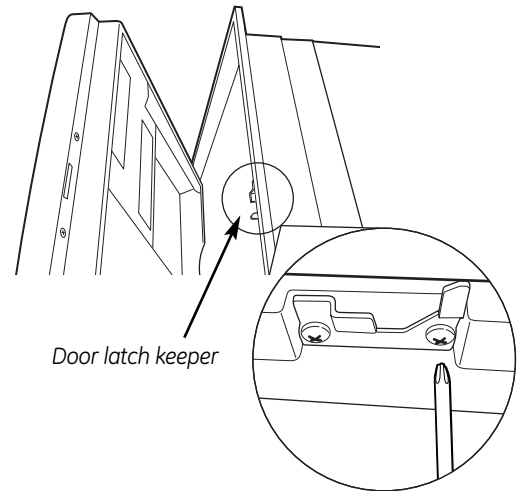

⚠ WARNING!

When using your dishwasher, follow basic precautions, including the following:

- Use this appliance only for its intended purpose as described in this Owner's Manual.
- Use only powder, tabs, liquid detergents or rinse agents recommended for use in a dishwasher and keep them out of the reach of children. **Cascade®**, **Cascade® Complete** and **Electrasol®** Automatic Dishwashing Detergents, and **Jet-Dry®** and **Cascade Crystal Clear®** rinse agents have been approved for use in all GE dishwashers.
- Locate sharp items so that they are not likely to damage the door seal.
- Load sharp knives with the handles up to reduce the risk of cut-type injuries.
- Do not wash plastic items unless marked dishwasher safe or the equivalent. For plastic items not so marked, check the manufacturer's recommendations.
- Do not touch the heating element during or immediately after use.
- Do not operate your dishwasher unless all enclosure panels are properly in place.
- Do not tamper with controls.
- Do not abuse, sit on or stand on the door or dish rack of the dishwasher.
- Do not allow children to play around the dishwasher when opening or closing the door due to the possibility of small fingers being pinched in the door.
- Do not discard a dishwasher without first removing the door of the washing compartment or the latch keeper.
- Do not store or use combustible materials, gasoline or other flammable vapors and liquids in the vicinity of this or any other appliance.
- Do not allow children to play with, on or inside this or any discarded appliance.



READ AND FOLLOW THIS SAFETY INFORMATION CAREFULLY.

SAVE THESE INSTRUCTIONS

About the dishwasher control panel

Control Settings

1 Cycles

An indicator light above the selected pad will be **ON** to indicate which **CYCLE** has been selected, on some models.

**POTS & PANS/
HEAVY WASH**
(on some models) For heavily soiled dishes or cookware with dried-on or baked-on soils. Everyday dishes may be included. This cycle will not remove burned-on foods.

**NORMAL/
NORMAL WASH** For loads of everyday dishes, glasses and cookware with medium soils. **NOTE:** Many dishes have lighter soil than normal. Choosing a cycle other than **NORMAL WASH** will save energy and water.

SHORT WASH
(on some models) For quickly washing loads of everyday dishes with medium soils that have not dried on, such as loads consisting mostly of glasses.

**WATER SAVER
LIGHT WASH**
(on some models) For dishes with light soils.

RINSE ONLY For rinsing partial loads that will be washed later. *Do not use detergent.*

**DRYING
PLATE WARMER** For warming clean dishes and serving plates. This cycle will take approximately 30 minutes.

**HOT PREWASH
HOT START** Preheats wash water to the correct temperature.

CHINA CRYSTAL
(on some models) For lightly soiled china and crystal.

2 Options

An indicator light above the selected pad will be **ON** to indicate which **OPTION** has been selected, on some models.

**HI TEMP
RINSE**
(on some models) Turns on the heater in all final rinse cycles to help prevent spotting on dishware. This option may be turned **ON** or **OFF** during the wash cycle.

**HI TEMP
WASH** Energizes the heater to boost water temperature in prewash and main wash fill cycles. Recommended for use with heavily soiled dishes. Option may be turned **ON** or **OFF** during the wash cycle.

**HEATED DRY
OFF** Shuts off the drying heat option. Dishes air dry naturally and energy is saved. Open the dishwasher door to speed drying.

**HEATED DRY
ON** Turns the heater on for fast drying. This cycle will extend the time to your wash cycle by 30 minutes. **DO NOT** use with **RINSE ONLY** cycle.

LOCK
(electronic models only) When the **LOCK** pad is touched twice within 3 seconds, all pads become inoperative. *You can lock the controls to prevent any selections from being made. Or you can lock the controls after you have started a cycle or selected **DELAY START** so the cycle or **DELAY START** is not interrupted.*
Children cannot accidentally start dishwasher by touching pads with this option selected.
To unlock the dishwasher after it has been locked, touch the **LOCK** pad twice within 3 seconds. The light above the **LOCK** pad will turn off.

DELAY HOURS
(on some models) Delays the start of a wash cycle for up to 8 hours.

RESET
(timer models) Touch **RESET** to cancel options.

START/RESET
(electronic models) Touch **START/RESET** one time to start dishwasher cycle. Touch **START/RESET** a second time to pump out and then turn off the dishwasher. Do not touch **START/RESET** more than one time unless you intend to end the cycle.

Control Settings

Cycle Chart

Model	Cycle	Water Usage (gal.)	Cycle Time (min.)
GSD1100	Hot Start Option ¹	2.5	10
	Heavy Wash	7.0	120
	Normal Wash	5.7	117
	Rinse Only	2.2	53
	Plate Warmer	0.0	40
HDA1100 ADW1100	Hot PreWash Option ¹	2.5	10
	Normal Wash	5.7	117
	Drying	0.0	40
GSD1300 GSD2100 GSD2101	Hot Start Option ¹	2.5	10
	Heavy Wash	7.0	120
	Normal Wash	5.7	117
	Light Wash	4.5	113
	Rinse Only	2.2	53
HDA2100	Hot PreWash Option ¹	2.5	10
	Heavy Wash	7.0	120
	Normal Wash	5.7	117
	Water Saver	4.5	113
	Rinse Only	2.2	53
HDA3500	Hot PreWash Option ¹	2.5	12
	Heavy Wash	7.0	118
	Normal Wash*	5.7	118
	Water Saver*	4.5	114
	Rinse Only*	2.2	53
GSD2300 GSD2301 GSM2200	Hot Start Option ¹	2.5	12
	Pots & Pans	7.0	118
	Normal Wash*	5.7	118
	Light Wash*	4.5	114
	Rinse Only*	2.2	53
GSD2700	Hot Start Option ¹	2.5	12
	Heavy Wash	7.0	118
	Normal Wash*	5.7	118
	Rinse Only*	2.2	53
	Plate Warmer	0.0	40
GSD3300	Hot Start Option ¹	2.5	12
	Pots & Pans	7.0	118
	Normal Wash*	5.7	118
	Rinse Only*	2.2	53
	Plate Warmer	0.0	40
GHDA350	Hot Start Option ¹	1.3	3
	Pots & Pans	8.2	103
	Heavy Wash	7.0	103
	Normal Wash*	5.7	103
	Light Wash*	3.4	95
	Rinse Only*	2.2	42
GSD4000	Plate Warmer	0.0	33
	Pots & Pans	8.8	112
	Heavy Wash	7.5	108
	Normal Wash	5.7	105
	China/Crystal	6.3	80
Rinse Only	1.3	3	

¹ Hot Start Option adds water amount and cycle time shown when selected.
* Normal Wash button should be pushed to run this cycle.

NOTE: Not all models have every cycle listed.

About the dishwasher control panel

You can locate your model number on the left tub wall just inside the door. Throughout this manual, features and appearance may vary from your model.

Please match the control panel for your unit to a similar control panel below.

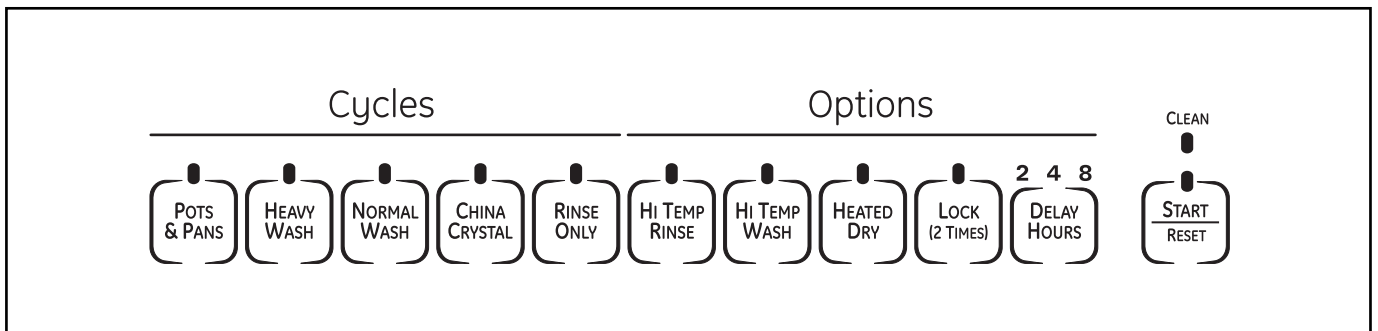
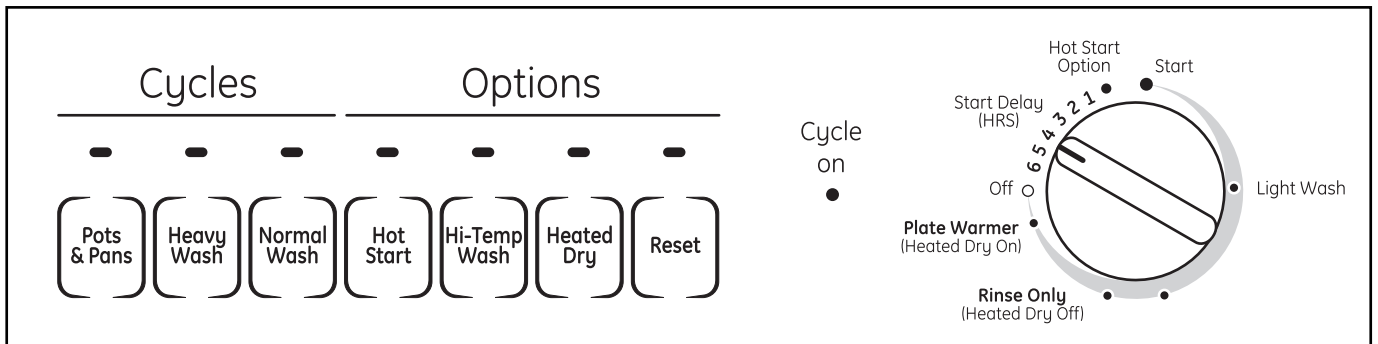
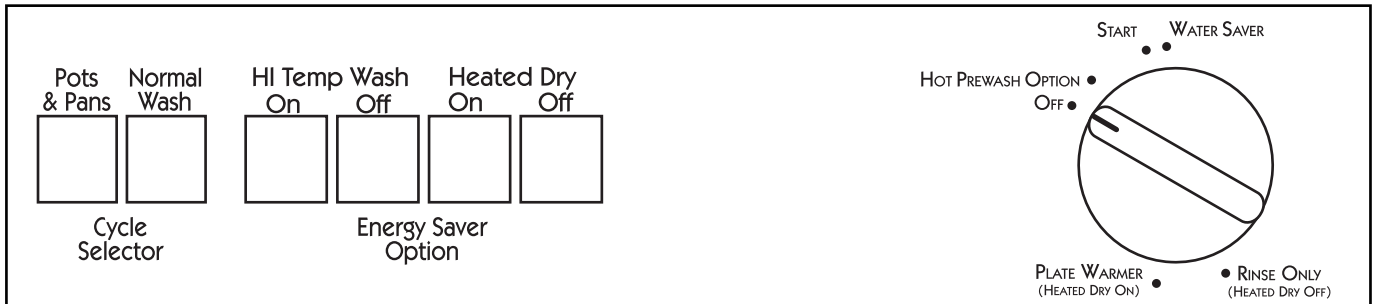
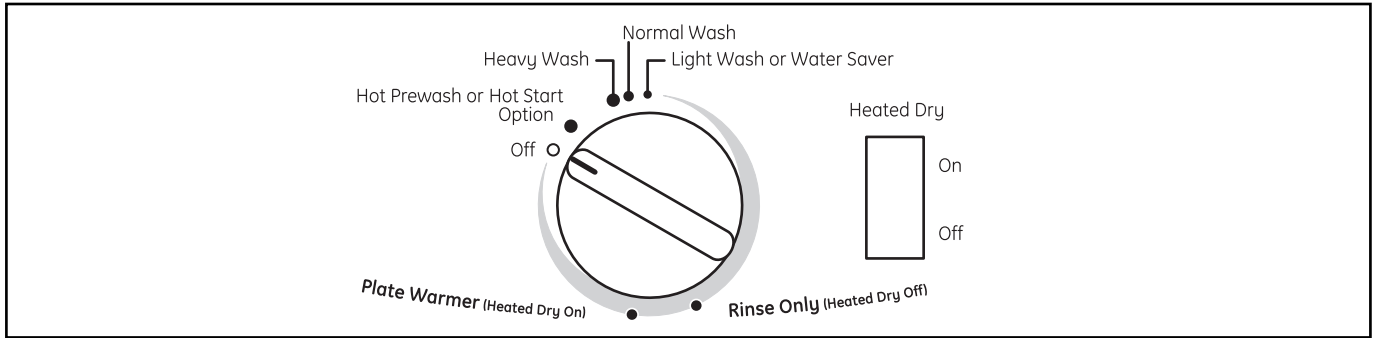



Rinse Only

For rinsing partial loads that will be washed later. *Do not use detergent.*

- 1 Make sure **HEATED DRY** is not selected.
- 2 Be sure the door is unlatched.
- 3 Slowly turn the Dial to **RINSE ONLY**.
- 4 Latch the door to start the cycle.



Plate Warmer or Drying

For warming clean dishes and serving plates. This cycle will take approximately 39 minutes.

- 1 Load clean dishware to be warmed.
- 2 Select **HEATED DRY ON**.
- 3 Be sure the door is unlatched.
- 4 Slowly turn the Dial to **PLATE WARMER or DRYING**.
- 5 Latch the door to start the cycle.



Hot Start or Hot Prestart Option

Preheats wash water.

- 1 Select the **HOT START** or **HOT PRESTART** cycle and any other option on the push button pad.
- 2 Be sure the door is unlatched.
- 3 Slowly turn the Dial to **HOT START** or **HOT PRESTART**.
- 4 Latch the door to start the cycle.

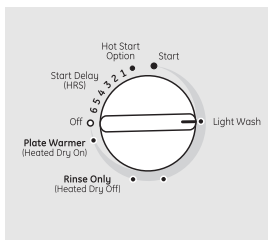

Short Wash or Light Wash or Water Saver

For quickly washing loads of everyday dishes with light to medium soils that have not dried on.

- 1 Be sure the door is unlatched.
- 2 Slowly turn the Dial to **SHORT WASH, LIGHT WASH** or **WATER SAVER**.
- 3 Latch the door to start the cycle.



Start Delay (on some models)

The **START DELAY** will allow you to delay the start time of any cycle automatically up to 6 hours.

- 1 Be sure the door is unlatched.
- 2 Select the wash cycle and option you want.
- 3 Slowly turn the Dial to the desired time. The **CYCLE ON** light will come on.
- 4 Latch the door to start the cycle.

Start (Models with a Dial)

Slowly turn the Dial to the **START** or **ON** position, or the selected cycle. Don't turn it past the **START, ON** or cycle position; you could accidentally miss a prewash.

There is a time delay between start-up and water fill so you will not hear any wash action right away.

- Latch the door to begin the cycle.

Operation of electronic models (model GSD4000 Only)

Using the Dishwasher Door

- 1 The door must be closed and locked into place to select a **LOAD SELECTION** or an **OPTION**.
- 2 If the door is opened during a cycle and left open, *the dishwasher will beep once every 30 seconds* until the door is closed and latched into place.

Start

Close and latch the door. Touch the **START/RESET** pad to begin the cycle. Water fill begins and approximately 60 seconds later the wash action begins.

NOTE: The dishwasher remembers your last cycle so you don't have to reprogram each time. When the dishwasher is loaded and the door latch is in the locked position, the control panel lights will be **ON** and display the last settings you selected.

If you don't want to change any of the settings, simply touch the **START/RESET** pad to begin the cycle.

Also, if a power failure occurs, **NORMAL** and **HEATED DRY** will automatically be programmed. Make any new selections and touch the **START/RESET** pad to begin the cycle.

Clean

This light is illuminated when a wash cycle is complete. The light will stay **ON** until the door is opened.

Flashing Display Lights

Lights	What It Means	What To Do
	This is normal. The START/RESET pad has been pressed.	Allow the dishwasher to drain and reset before you start a new wash cycle.
 PLUS A BEEPING SOUND	Control Error	Press the START/RESET pad to turn off the beeper. If the CLEAN light continues to flash, call for service.
 PLUS A BEEPING SOUND	Control Error	Press the START/RESET pad to turn off the beeper and the dishwasher will attempt to reset. Restart the wash cycle. If this error continues, turn off the power to the dishwasher at the circuit breaker for 30 seconds. Try the dishwasher again. If the error is still present, call for service.



Check the Water Temperature

The entering water must be at least 120°F and not more than 150°F, for effective cleaning and to prevent dish damage. Check the water temperature with a candy or meat thermometer. Turn on the hot water faucet nearest the dishwasher, place the thermometer in a glass and let the water

run continuously into the glass until the temperature stops rising.

Adjust the maximum/minimum temperature of the water heater if necessary to deliver water at the proper temperature.



Use Jet-Dry® Rinse Agent

Jet-Dry® or **Cascade Crystal Clear®** rinse agents remove spots and prevent new film buildup on dishes, glasses, flatware, cookware and plastic.

Filling the Dispenser

Fill the rinse agent dispenser until it reaches the bottom of lip inside the opening. Replace cap.

To check if rinse agent is needed, remove the cap and look into the dispenser.

A full dispenser should last about one month.

If the rinse agent spills, wipe up the excess.

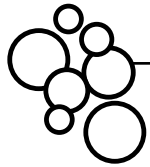
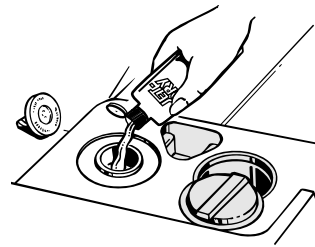

Proper Use of Detergent

Use only detergent specifically made for use in dishwashers. **Cascade®** and **Electrasol®** Automatic Dishwashing Detergents have been approved for use in all GE dishwashers. Keep your detergent fresh and dry. Don't put powder detergent into the dispenser until you're ready to wash dishes.

The amount of detergent to use depends on whether your water is *hard* or *soft*. With hard water, you need extra detergent. With soft water, you need less detergent.

Protect your dishes and dishwasher by contacting your water department and asking how hard your water is. Twelve or more grains is extremely hard water. A water softener is recommended. Without it, lime can build up in the water valve, which could stick while open and cause flooding. Too much detergent with soft water can cause a permanent cloudiness of glassware, called *etching*.

Use the information in the table below as a guideline to determine the amount of automatic dishwasher detergent to place in the dispenser.

Number of Grains	Detergent Cups to Fill
Less than 4	Fill to 1/3 of main cup
4 to 8	Fill to 2/3 of main cup
8 to 12	Fill main cup
Greater than 12	Fill main cup and open cup

You'll find two detergent dispensers on the inside door of your dishwasher. All wash cycles require detergent in the main cup. When using automatic dishwashing detergent tabs, simply place one tab in the main cup and close.

Be sure the Dial is **OFF** before adding detergent. Otherwise, the detergent cup will not close and latch properly. Add detergent then close the main cup.

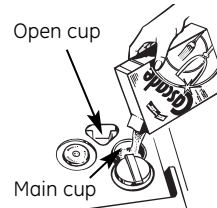

NOTE: To open detergent cup after it has been closed, simply turn the detergent cup handle counterclockwise until it releases. A snapping sound may be heard.

DO NOT USE HAND DISH DETERGENT

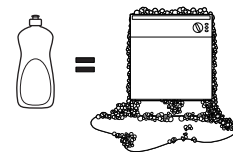

NOTE: Using a detergent that is not specifically designed for dishwashers will cause the dishwasher to fill with suds. During operation, these suds will spill out of the dishwasher vents, covering the kitchen floor and making the floor wet.

Because so many detergent containers look alike, store the dishwasher detergent in a separate space from all other cleaners. Show anyone who may use the dishwasher the correct detergent and where it is stored.

While there will be no lasting damage to the dishwasher, your dishes will not get clean using a dishwashing detergent that is not formulated to work with dishwashers.

Loading the dishwasher racks

For best dishwashing results, follow these loading guidelines. Features and appearance of racks and silverware baskets may vary from your model.

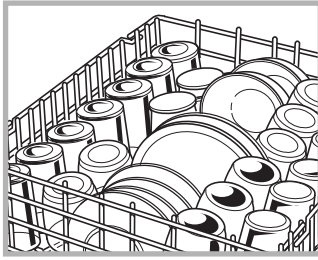

Upper Rack

The upper rack is for glasses, cups and saucers. Cups and glasses fit best along the sides. This is also a secure place for dishwasher-safe plastics. The upper rack is good for all kinds of odd-shaped utensils. Saucepans, mixing bowls and other items should be placed face down.

Secure larger dishwasher-safe plastics over two fingers when possible.

Make sure small plastic items are secure so they can't fall onto the heating element.

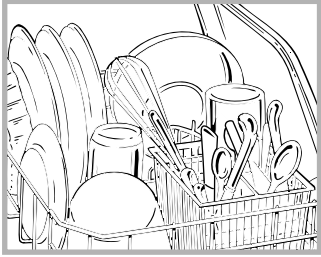

Lower Rack

When loading the lower rack, do not load large platters or trays in the front right corner. They may prevent detergent from circulating during the wash cycle.

The lower rack is best used for plates, saucers and cookware. Large items such as broiler pans and racks should go along the sides. Load platters, pots and bowls along the sides, in corners or in the back. The soiled side of items should face the center of the rack.

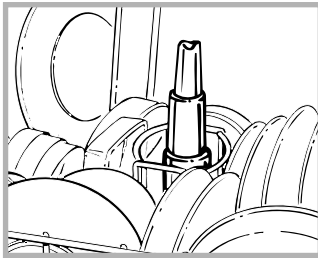

Wash Tower

Keep the center area clear in the lower rack.

The wash tower rises through the center of the lower rack during the wash and rinse portions of the cycle.



Don't block the wash tower or load tall things next to it.

Be sure items don't fall through rack and block rotation of the spray arm.

Also, be careful not to let a portion of an item such as a pot or dish handle extend through the bottom rack. This could block the wash arm and cause poor washing results.

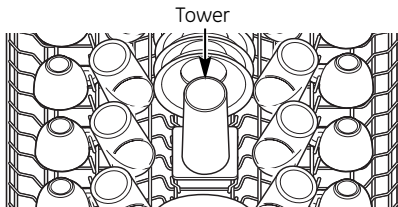

Don't block the upper rack wash tower.

Do not cover upper rack tower (not present on all models)



Silverware Basket

Put flatware in the removable basket with fork and knife handles up to protect your hands. Place spoons in the basket with handles down. Mix knives, forks and spoons so they don't nest together. Distribute evenly. Small plastic items, such as measuring spoons and lids from small containers, should go in the bottom of the silverware basket with silverware on top.

DON'T LET ANY ITEM EXTEND THROUGH BOTTOM OF SILVERWARE BASKET AND RACK, TO ENSURE PROPER FUNCTION OF SPRAY ARM.

Loading place settings...

Follow these guidelines for loading 10 place settings. Features and appearance of racks and silverware baskets may vary from your model.

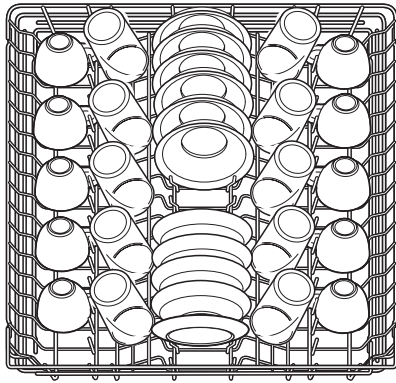

Upper Rack—10 place settings

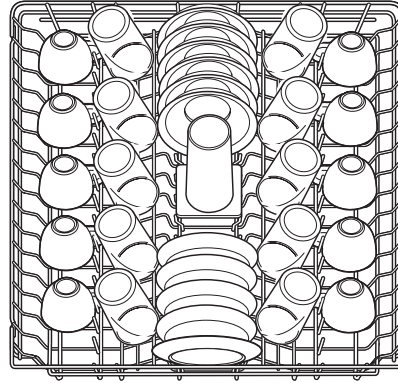

Upper Rack—10 place settings

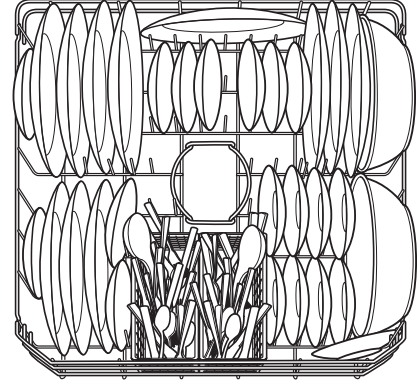

Lower Rack—10 place settings

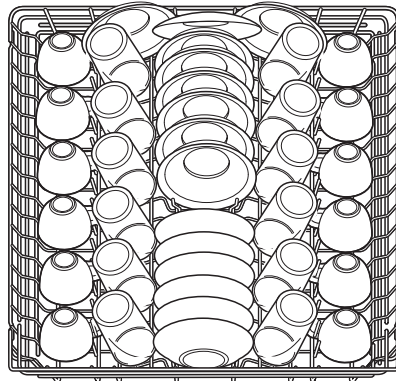

Upper Rack—12 place settings

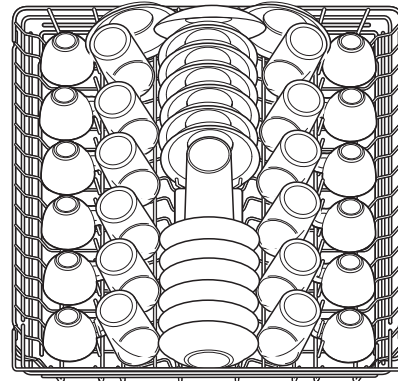

Upper Rack—12 place settings

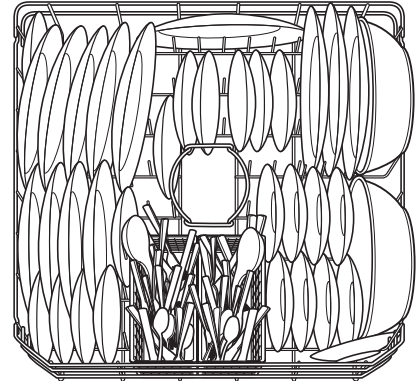

Lower Rack—12 place settings

Forget to Add a Dish?

A forgotten dish can be added any time before the main wash.

- 1 Push the door latch to the left.
- 2 Once the water calms, open the door. Steam may rise out of the dishwasher.
- 3 Add forgotten dish.
- 4 Close the door and push the latch to the far right.

Tips for Loading and Good Wash Performance

- Don't block the lower rack wash tower.



- Don't let items fall through rack and block spray arms.



Caring for the dishwasher

To clean the control panel, use a lightly dampened cloth, then dry thoroughly. To clean the exterior, use a good appliance polish. Never use sharp objects, scouring pads or harsh cleaners on any part of the dishwasher.

Protect Against Freezing

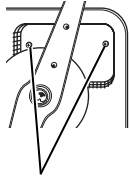

Sump cover screws

If your dishwasher is left in an unheated place during the winter, ask a service technician to:

- 1 Cut off electrical power to the dishwasher. Remove fuses or trip circuit breaker.
- 2 Turn off the water supply and disconnect the water inlet line from the water valve.

- 3 Drain water from the inlet line and water valve. (Use a pan to catch the water.)
- 4 Reconnect the water inlet line to the water valve.
- 5 Remove the plastic sump cover in the tub bottom and use a sponge to soak up water in the rubber boot.

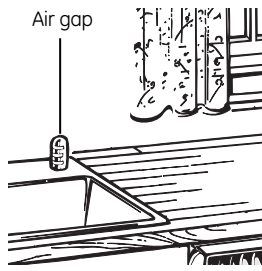

Check the air gap any time your dishwasher isn't draining well.

Does Your Dishwasher Have an Air Gap?

An air gap protects your dishwasher against water backing up into it if a drain clogs. The air gap is not a part of the dishwasher. It is not covered by your warranty. Not all plumbing codes require air gaps, so you may not have one.

The air gap is easy to clean.

- 1 Turn off the dishwasher and lift off the chrome cover.
- 2 Unscrew the plastic cap and clean with a toothpick.

Stainless Steel Panels

The stainless steel panels can be cleaned with *Stainless Steel Magic* or a similar product using a clean, soft cloth.

You can order *Stainless Steel Magic* #WX10X15 through GE Parts by calling 800.626.2002.

Optional accessories

You can change the appearance of your dishwasher by adding a custom panel trim kit.

1/4" Wood panel trim kit—This accessory contains *trim and instructions* for you to supply and install a 1/4" thick decorative wood door:

- GPF25B (Black) GPF325B/GPF425B
- GPF25W (White) GPF325W/GPF425W
- GPF25C (Bisque) GPF325C/GPF425C

3/4" Trimless wood panel kit—This accessory contains *parts and instructions* for you to supply and install a 3/4" thick decorative wood door:

- GPF375/GPF475

NOTE: The GPF100 dishwasher door spring kit must also be ordered and installed when the door panel weighs four lbs. or more. This kit is included with the 3/4" trim kits.

Non-wood countertop bracket kit—This is for installations which have non-wood countertops and includes side-mounting brackets and instructions for securing the dishwasher:

- GPF65

Consult your GE Appliance dealer to get the correct kit for your model.

These accessories are available at extra cost from GE. Call 800.626.2002 to order, or see your authorized GE Appliance dealer. Visa, MasterCard or Discover cards are accepted. Specify accessory number when ordering.



Troubleshooting Tips
 Save time and money! Review the charts on the following pages, or visit ge.com. You may not need to call for service.

Problem	Possible Causes	What To Do
Dishwasher won't run	Fuse is blown, or the circuit breaker tripped	<ul style="list-style-type: none"> Replace fuse or reset circuit breaker. Remove any other appliances from the circuit. Try pressing the START/RESET pad (Electronic models) two times.
	Power is turned off	<ul style="list-style-type: none"> In some installations, power to the dishwasher is provided through a wall switch, often located next to the disposer switch. Make sure it is on.
Noise	Some of the sounds you'll hear are normal	<ul style="list-style-type: none"> Soft food disposal shredding action. Drain valve opening to pump water out. Timer control as cycle progresses. Detergent cup opening. The motor stopping during the drying period. Water draining out of tub immediately after touching the START/RESET pad.
	Utensils are not secure in rack or something small has dropped into rack	<ul style="list-style-type: none"> Make sure everything is secured in dishwasher.
	Rattling dishes when the spray arm rotates	<ul style="list-style-type: none"> Make sure dishes are properly loaded. See the <i>Loading the dishwasher racks</i> section.
	Motor hums	<ul style="list-style-type: none"> Dishwasher has not been used on a regular basis. If you do not use your dishwasher often, set it to fill and pump out once every week. This will help keep the seal moist.
Water standing in the bottom of the tub	This is normal	<ul style="list-style-type: none"> A small amount of clean water around the outlet on the tub bottom at the back of the tub keeps the water seal lubricated.
Water won't pump out of the tub	Drain is clogged	<ul style="list-style-type: none"> If you have an air gap, clean it. Check to see if your kitchen sink is draining well. If not, you may need a plumber. If the dishwasher drains into a disposer, run disposer clear.
Suds in the tub	Wrong detergent was used	<ul style="list-style-type: none"> Use only automatic dishwasher detergents to avoid sudsing. Cascade®, Cascade® Complete and Electrasol® Automatic Dishwashing Detergents have been approved for use in all GE dishwashers. To remove suds from the tub, open the dishwasher and let suds dissipate. Add 1 gallon of cold water to the tub. On Models with a Dial: Close and latch the dishwasher. Pump out water by slowly turning the Dial until a drain period is reached. Repeat if necessary. On Models with Electronic Control: Pump out water by pressing the START/RESET pad, then 10 seconds later, press START/RESET pad again. Repeat if necessary.
	Rinse agent was spilled	<ul style="list-style-type: none"> Always wipe up rinse agent spills immediately.
Stained tub interior	Some tomato-based foods can cause reddish stains	<ul style="list-style-type: none"> Use of the RINSE ONLY cycle after adding the dish to the load can decrease the level of staining. GE recommends Cascade® Plastic Booster to help remove these types of stains.
	Tea or coffee stains	<ul style="list-style-type: none"> Remove the stain by hand, using a solution of 1/2 cup bleach and 3 cups warm water. <p>▲ WARNING Before cleaning interior, wait at least 20 minutes after a cycle for the heating elements to cool down. Failure to do so can result in burns.</p>
	An overall yellow or brown film can be caused by iron deposits in water	<ul style="list-style-type: none"> A special filter in the water supply line is the only way to correct this problem. Contact a water softener company.
	White film on inside surface—hard water minerals	<ul style="list-style-type: none"> GE recommends Jet-Dry® or Cascade Crystal Clear® to help prevent hard water mineral deposits from forming. Run dishwasher with citric acid to remove mineral deposits. Citric acid (Part number: WD35X151) can be ordered through GE Parts. See back cover for ordering information.

Before you call for service...

Safety Instructions

Operating Instructions

Troubleshooting Tips

Consumer Support

<i>Problem</i>	<i>Possible Causes</i>	<i>What To Do</i>
<i>Dishes don't dry</i>	Low inlet water temperature	<ul style="list-style-type: none"> • Make sure inlet water temperature is at least 120°F. • Select HEATED DRY. • Use HOT START and ADDED HEAT options. • Select a higher cycle, such as POTS & PANS or HEAVY WASH.
	Rinse agent dispenser is empty	<ul style="list-style-type: none"> • Check the rinse agent dispenser and fill as required.
<i>Dishes and flatware not clean</i>	Inlet water temperature is below 120°F.	<ul style="list-style-type: none"> • Raise the water heater temperature to 120°F. • Use HOT START, POTS & PANS or HEAVY WASH and HI TEMP WASH.
	Too little detergent	<ul style="list-style-type: none"> • See <i>Using the dishwasher</i> section, refer to <i>Proper Use of Detergent</i> for detergent recommendations.
	Old or damp powdered detergent	<ul style="list-style-type: none"> • See <i>Using the dishwasher</i> section, refer to <i>Proper Use of Detergent</i> for detergent recommendations.
	Water pressure is temporarily low	<ul style="list-style-type: none"> • Turn on a faucet. Is water coming out more slowly than usual? If so, wait until pressure is normal before using your dishwasher.
	Air gap is clogged	<ul style="list-style-type: none"> • Clean the air gap.
<i>Spots and filming on glasses and flatware</i>	Improper rack loading No air gap or high drain loop	<ul style="list-style-type: none"> • Make sure large dishware does not block detergent dispenser or wash arm. • Verify that you have an air gap or a high drain loop. Refer to the Installation Instructions.
	Extremely hard water	<ul style="list-style-type: none"> • Use Jet-Dry® or Cascade Crystal Clear® rinse agents to remove spots and prevent new film buildup. • To remove stubborn spots and pre-existing film from glassware: <ol style="list-style-type: none"> 1 Remove all metal utensils from the dishwasher. 2 Do not add detergent. 3 Select the longest cycle. 4 Start the dishwasher and allow to run for 18 to 22 minutes. Dishwasher will now be in the main wash. 5 Open the door and pour 2 cups (500 ml) of white vinegar into the bottom of the dishwasher. 6 Close the door and allow to complete the cycle. If vinegar rinse doesn't work: Repeat as above, except use 1/4 cup (60 ml) of citric acid crystals instead of vinegar.
	Low inlet water temperature	
	Overloading the dishwasher	
	Improper loading	
	Old or damp powder detergent	
Rinse agent dispenser empty		
Too little detergent		
<i>Cloudiness on glassware</i>	Combination of soft water and too much detergent	<ul style="list-style-type: none"> • This is called <i>etching</i> and is permanent. To prevent this from happening, use less detergent if you have soft water. Wash glassware in the shortest cycle that will get it clean.
	Water temperature entering the dishwasher exceeds 150°F.	<ul style="list-style-type: none"> • Lower the water heater temperature.
<i>Detergent cup lid won't latch</i>	Dial is not in the OFF position	<ul style="list-style-type: none"> • Turn the Timer Dial to OFF.
<i>Detergent left in dispenser cups</i>	Dishes are blocking the detergent cups	<ul style="list-style-type: none"> • Reposition the dishes.
<i>Steam</i>	This is normal	<ul style="list-style-type: none"> • Steam comes through the vent by the door latch during drying and when water is being pumped out.
<i>Black or gray marks on dishes</i>	Aluminum utensils have rubbed against dishes	<ul style="list-style-type: none"> • Remove marks with a mild, abrasive cleaner.
<i>Control panel lights go off when you are setting controls</i>	Time too long between touching or selecting pads	<ul style="list-style-type: none"> • Each pad must be touched within 30 seconds of the others. To relight, touch any pad again or unlatch and relatch the door.
<i>Control panel responded to inputs but dishwasher never filled with water</i>	Door latch may not be properly seated	<ul style="list-style-type: none"> • Call for service.

GE Dishwasher Warranty



All warranty service provided by our Factory Service Centers, or an authorized Customer Care[®] technician. To schedule service, on-line, 24 hours a day, visit us at ge.com, or call 800.GE.CARES (800.432.2737). Please have serial number and model number available when calling for service.

Staple your receipt here.
Proof of the original purchase date is needed to obtain service under the warranty.

For The Period Of: **GE Will Replace:**

One Year

From the date of the original purchase

Any part of the dishwasher which fails due to a defect in materials or workmanship. During this **limited one-year warranty**, GE will also provide, **free of charge**, all labor and in-home service to replace the defective part.

What Is Not Covered:

- Service trips to your home to teach you how to use the product.
- Improper installation, delivery or maintenance.
- Failure of the product if it is abused, misused, or used for other than the intended purpose or used commercially.
- Replacement of house fuses or resetting of circuit breakers.
- Damage to the product caused by accident, fire, floods or acts of God.
- Incidental or consequential damage caused by possible defects with this appliance.
- Cleaning or servicing of the air gap device in the drain line.
- Damage caused after delivery.
- Product not accessible to provide required service.

EXCLUSION OF IMPLIED WARRANTIES—Your sole and exclusive remedy is product repair as provided in this Limited Warranty. Any implied warranties, including the implied warranties of merchantability or fitness for a particular purpose, are limited to one year or the shortest period allowed by law.

This warranty is extended to the original purchaser and any succeeding owner for products purchased for home use within the USA. If the product is located in an area where service by a GE Authorized Servicer is not available, you may be responsible for a trip charge or you may be required to bring the product to an Authorized GE Service location. In Alaska, the warranty excludes the cost of shipping or service calls to your home.

Some states do not allow the exclusion or limitation of incidental or consequential damages. This warranty gives you specific legal rights, and you may also have other rights which vary from state to state. To know what your legal rights are, consult your local or state consumer affairs office or your state's Attorney General.

Warrantor: General Electric Company. Louisville, KY 40225

Consumer Support



GE Appliances Website

ge.com

Have a question or need assistance with your appliance? Try the GE Appliances Website 24 hours a day, any day of the year! For greater convenience and faster service, you can now download Owner's Manuals, order parts or even schedule service on-line.



Schedule Service

ge.com

Expert GE repair service is only one step away from your door. Get on-line and schedule your service at your convenience 24 hours any day of the year! Or call 800.GE.CARES (800.432.2737) during normal business hours.



Real Life Design Studio

ge.com

GE supports the Universal Design concept—products, services and environments that can be used by people of all ages, sizes and capabilities. We recognize the need to design for a wide range of physical and mental abilities and impairments. For details of GE's Universal Design applications, including kitchen design ideas for people with disabilities, check out our Website today. For the hearing impaired, please call 800.TDD.GEAC (800.833.4322).



Extended Warranties

ge.com

Purchase a GE extended warranty and learn about special discounts that are available while your warranty is still in effect. You can purchase it on-line anytime, or call 800.626.2224 during normal business hours. GE Consumer Home Services will still be there after your warranty expires.



Parts and Accessories

ge.com

Individuals qualified to service their own appliances can have parts or accessories sent directly to their homes (VISA, MasterCard and Discover cards are accepted). Order on-line today, 24 hours every day or by phone at 800.626.2002 during normal business hours.

Instructions contained in this manual cover procedures to be performed by any user. Other servicing generally should be referred to qualified service personnel. Caution must be exercised, since improper servicing may cause unsafe operation.



Contact Us

ge.com

If you are not satisfied with the service you receive from GE, contact us on our Website with all the details including your phone number, or write to:

General Manager, Customer Relations
GE Appliances, Appliance Park
Louisville, KY 40225

In Canada write to: Director, Customer Relations, Mabe Canada Inc.
Suite 310, 1 Factory Lane
Moncton, N.B. E1C 9M3



Register Your Appliance

ge.com

Register your new appliance on-line—at your convenience! Timely product registration will allow for enhanced communication and prompt service under the terms of your warranty, should the need arise. You may also mail in the pre-printed registration card included in the packing material.



Printed in the United States
Printed on Recycled Paper